



**WLG4S-3P3432**

W4S-3 Glass

**MINIATURE PHOTOELECTRIC SENSORS**

**SICK**  
Sensor Intelligence.



Illustration may differ



### Ordering information

Type	Part no.
WLG4S-3P3432	1051097

Other models and accessories → [www.sick.com/W4S-3\\_Glass](http://www.sick.com/W4S-3_Glass)

### Detailed technical data

#### Features

<b>Sensor/ detection principle</b>	Photoelectric retro-reflective sensor, autocollimation
<b>Dimensions (W x H x D)</b>	12.2 mm x 41.8 mm x 17.3 mm
<b>Housing design (light emission)</b>	Rectangular
<b>Sensing range max.</b>	0.01 m ... 5 m <sup>1)</sup>
<b>Sensing range</b>	0 m ... 3 m <sup>1)</sup>
<b>Type of light</b>	Visible red light
<b>Light source</b>	PinPoint LED <sup>2)</sup>
<b>Light spot size (distance)</b>	Ø 45 mm (1.5 m)
<b>Wave length</b>	650 nm
<b>Adjustment</b>	Single teach-in button
<b>AutoAdapt</b>	✓
<b>Special applications</b>	Detecting transparent objects

<sup>1)</sup> Reflector PL80A.

<sup>2)</sup> Average service life: 100,000 h at T<sub>U</sub> = +25 °C.

Mechanics/electronics

<b>Supply voltage</b>	10 V DC ... 30 V DC <sup>1)</sup>
<b>Ripple</b>	< 5 V <sub>pp</sub> <sup>2)</sup>
<b>Power consumption</b>	20 mA <sup>3)</sup>
<b>Switching output</b>	PNP
<b>Output function</b>	Complementary
<b>Switching mode</b>	Light/dark switching
<b>Output current I<sub>max.</sub></b>	≤ 100 mA
<b>Response time</b>	< 0.5 ms <sup>4)</sup>
<b>Switching frequency</b>	1,000 Hz <sup>5)</sup>
<b>Angle of reception</b>	30°
<b>Attenuation along light beam</b>	> 8 %
<b>Connection type</b>	Cable with M12 male connector, 4-pin, 150 mm <sup>6)</sup>
<b>Cable material</b>	PVC
<b>Conductor cross-section</b>	0.14 mm <sup>2</sup>
<b>Cable diameter</b>	Ø 3.4 mm
<b>Circuit protection</b>	A <sup>7)</sup> C <sup>8)</sup> D <sup>9)</sup>
<b>Protection class</b>	III
<b>Weight</b>	30 g
<b>Polarisation filter</b>	✓
<b>Housing material</b>	Plastic, ABS
<b>Optics material</b>	Plastic, PMMA
<b>Enclosure rating</b>	IP67 IP66
<b>Special feature</b>	Detecting transparent objects
<b>Ambient operating temperature</b>	-40 °C ... +60 °C
<b>Ambient storage temperature</b>	-40 °C ... +75 °C
<b>UL File No.</b>	NRKH.E181493 & NRKH7.E181493

- 1) Limit values.
- 2) May not exceed or fall below U<sub>v</sub> tolerances.
- 3) Without load.
- 4) Signal transit time with resistive load.
- 5) With light/dark ratio 1:1.
- 6) Do not bend below 0 °C.
- 7) A = V<sub>S</sub> connections reverse-polarity protected.
- 8) C = interference suppression.
- 9) D = outputs overcurrent and short-circuit protected.

Classifications

<b>ECl@ss 5.0</b>	27270902
<b>ECl@ss 5.1.4</b>	27270902
<b>ECl@ss 6.0</b>	27270902

<b>ECl@ss 6.2</b>	27270902
<b>ECl@ss 7.0</b>	27270902
<b>ECl@ss 8.0</b>	27270902
<b>ECl@ss 8.1</b>	27270902
<b>ECl@ss 9.0</b>	27270902
<b>ETIM 5.0</b>	EC002717
<b>ETIM 6.0</b>	EC002717
<b>UNSPSC 16.0901</b>	39121528

### Connection diagram

Cd-094

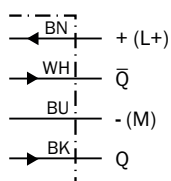

### Characteristic curve

WL4S-3, WLG4S-3, 5 m

Operating reserve

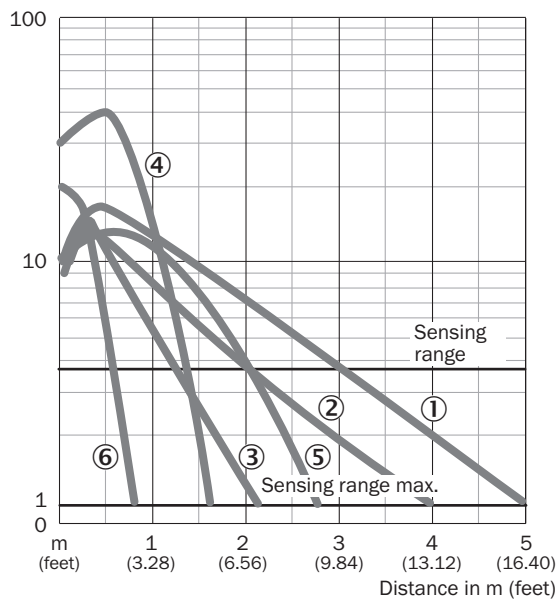

- ① Reflector PL80A
- ② Reflector PL40A
- ③ Reflector PL20A
- ④ PL10F reflector
- ⑤ Reflector P250 CHEM
- ⑥ Reflective tape REF-IRF-56

### Light spot size

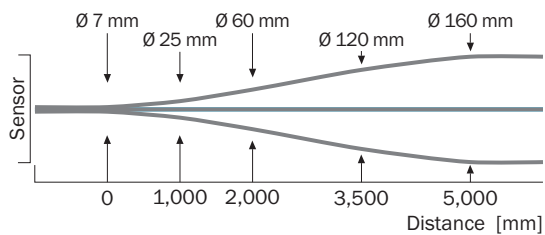

### Sensing range diagram

WL4S-3, WLG4S-3, 5 m

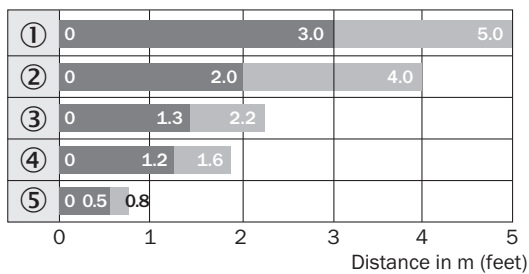

■ Sensing range      ■ Sensing range max.

- ① Reflector PL80A
- ② Reflector PL40A
- ③ Reflector PL20A
- ④ PL10F reflector
- ⑤ Reflective tape REF-IRF-56

**Dimensional drawing** (Dimensions in mm (inch))

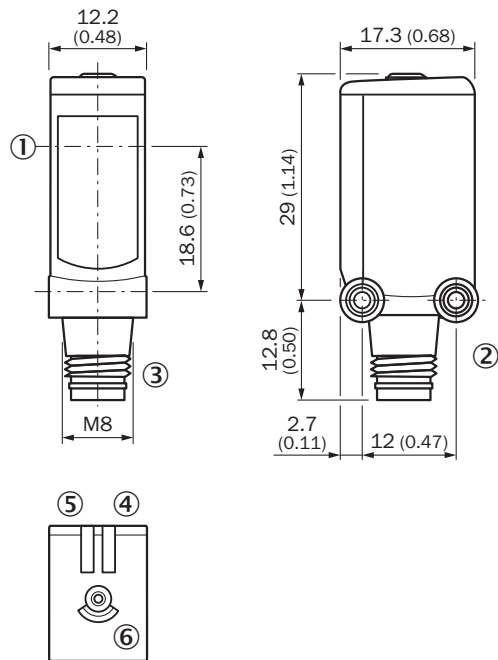

WL4S-3, WLG4S-3, single teach-in button







- ① Center of optical axis
- ② Threaded mounting hole M3
- ③ Connection
- ④ LED indicator green: Supply voltage active
- ⑤ Orange LED indicator: status of received light beam
- ⑥ Teach-in button

**Recommended accessories**

Other models and accessories → [www.sick.com/W4S-3\\_Glass](http://www.sick.com/W4S-3_Glass)

	Brief description	Type	Part no.
<b>Universal bar clamp systems</b>			
	Plate N02 for universal clamp bracket, Zinc plated steel (sheet), Zinc die cast (clamping bracket), Universal clamp (5322626), mounting hardware	BEF-KHS-N02	2051608
	Plate N02N for universal clamp bracket, Stainless steel 1.4571 (sheet), Stainless steel 1.4408 (clamp), Universal clamp (5322627), mounting hardware	BEF-KHS-N02N	2051618
	Plate N08 for universal clamp bracket, Zinc plated steel (sheet), Zinc die cast (clamping bracket), Universal clamp (5322626), mounting hardware	BEF-KHS-N08	2051607
	Plate N08N for universal clamp bracket, Stainless steel 1.4571 (sheet), Stainless steel 1.4408 (clamp), Universal clamp (5322626), mounting hardware	BEF-KHS-N08N	2051616
<b>Device protection (mechanical)</b>			
	Safety bracket for floor mounting, Stainless steel 1.4571, mounting hardware included	BEF-SW-W4S	2051497

	Brief description	Type	Part no.
<b>Plug connectors and cables</b>			
	Head A: female connector, M12, 4-pin, straight, A-coded Head B: Flying leads Cable: Sensor/actuator cable, PVC, unshielded, 2 m	YF2A14-020VB3XLEAX	2096234
	Head A: female connector, M12, 4-pin, straight, A-coded Head B: Flying leads Cable: Sensor/actuator cable, PVC, unshielded, 5 m	YF2A14-050VB3XLEAX	2096235
	Head A: female connector, M12, 4-pin, angled, A-coded Head B: Flying leads Cable: Sensor/actuator cable, PVC, unshielded, 2 m	YG2A14-020VB3XLEAX	2095895
	Head A: female connector, M12, 4-pin, angled, A-coded Head B: Flying leads Cable: Sensor/actuator cable, PVC, unshielded, 5 m	YG2A14-050VB3XLEAX	2095897
	Head A: female connector, M12, 4-pin, straight Head B: - Cable: unshielded	DOS-1204-G	6007302
	Head A: female connector, M12, 4-pin, angled Head B: - Cable: unshielded	DOS-1204-W	6007303
	Head A: male connector, M12, 4-pin, straight Head B: - Cable: unshielded	STE-1204-G	6009932
	Head A: male connector, M12, 4-pin, angled Head B: - Cable: unshielded	STE-1204-W	6022084
<b>Reflectors</b>			
	Rectangular, screw connection, 80 mm x 80 mm, PMMA/ABS, Screw-on, 2 hole mounting	PL80A	1003865
	Fine triple reflector, screw connection, suitable for laser sensors, 47 mm x 47 mm, PMMA/ABS, Screw-on, 2 hole mounting	P250F	5308843
	Fine triple reflector, screw connection, suitable for laser sensors, 18 mm x 18 mm, PMMA/ABS, Screw-on, 2 hole mounting	PL10F	5311210
	Fine triple reflector, screw connection, suitable for laser sensors, 38 mm x 16 mm, PMMA/ABS, Screw-on, 2 hole mounting	PL20F	5308844
	Fine triple reflector, screw connection, suitable for laser sensors, 56 mm x 28 mm, PMMA/ABS, Screw-on, 2 hole mounting	PL30F	5326523
	Fine triple reflector, screw connection, suitable for laser sensors, 76 mm x 45 mm, PMMA/ABS, Screw-on, 2 hole mounting	PL81-1F	5325060
	Suitable for laser sensors, self-adhesive, cut, see alignment note, 56.3 mm x 56.3 mm, self-adhesive	REF-AC1000-56	4063030
	Fine triple reflector, chemically resistant, screw connection, 18 mm x 18 mm, plastic, Screw-on, 2 hole mounting	PL10F CHEM	5321636

	Brief description	Type	Part no.
	Chemically resistant, screw connection, suitable for laser sensors, 16 mm x 38 mm, plastic, Screw-on, 2 hole mounting	PL20F-CHEM	5326089
	Stainless steel reflector, hygienic design, chemically resistant, enclosure rating IP69K, D12 adapter shaft, PMMA front screens, 25 mm x 25 mm, Stainless steel V4A (1.4404, 316L), D12-adapter shaft	PLH25-D12	2063404
	Stainless steel reflector, hygienic design, chemically resistant, Enclosure rating IP 69K, M12-adapter thread, PMMA front screens, 25 mm x 25 mm, Stainless steel V4A (1.4404, 316L), M12-adapter thread	PLH25-M12	2063403
	Stainless steel reflector, washdown design, chemically resistant, IP 69K enclosure rating, screw connection, PMMA front screens, 14 mm x 14 mm, Stainless steel V4A (1.4404, 316L), Screw-on, 2 hole mounting	PLV14-A	2063405



## SICK AT A GLANCE

SICK is one of the leading manufacturers of intelligent sensors and sensor solutions for industrial applications. A unique range of products and services creates the perfect basis for controlling processes securely and efficiently, protecting individuals from accidents and preventing damage to the environment.

We have extensive experience in a wide range of industries and understand their processes and requirements. With intelligent sensors, we can deliver exactly what our customers need. In application centers in Europe, Asia and North America, system solutions are tested and optimized in accordance with customer specifications. All this makes us a reliable supplier and development partner.

Comprehensive services complete our offering: SICK LifeTime Services provide support throughout the machine life cycle and ensure safety and productivity.

For us, that is “Sensor Intelligence.”

## WORLDWIDE PRESENCE:

Contacts and other locations –[www.sick.com](http://www.sick.com)