

Data sheet | Item number: 770-684

h-distribution connector; 3-pole; Cod. A; 1 input; 2 outputs; outputs on one side; 2 locking levers; white

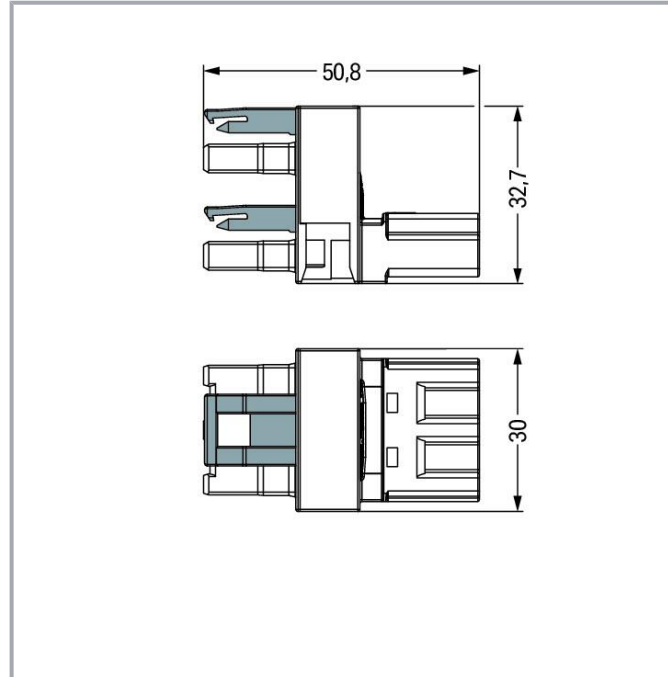

www.wago.com/770-684



Item description

Distribution connector *WINSTA*® MIDI with protection type IP20

The *WINSTA*® MIDI distribution connector 3-pole supports fast, reliable installation. Our pluggable installation connectors with spring pressure connection technology work entirely without screw connections. They allow fast, efficient, error-free installation in numerous applications. The coding options reduce installation errors, allowing fast, secure wiring of all components. The pluggable installation connector is protected in accordance with protection type IP20 (When mated: IP2xC (These compact connectors are not designed for use in open, easily accessible areas!)). That results in the fact that users' fingers will never come into contact with energised contact elements. The *WINSTA*® MIDI pluggable installation connector with A coding in white or black is usually used for general mains applications in power distribution. This pluggable installation connector is designed for a current load of up to 25 A. Therefore, it can also be used for high power loads. *WINSTA*® MIDI with Push-in CAGE CLAMP® spring pressure connection technology is found in a broad range of individual products you can use for quick, easy and maximally flexible electrical installation.

Subject to changes. Please also observe the further product documentation!

WAGO GmbH & Co. KG
Hansastr. 27
32423 Minden
Phone: +49571 887-0 | Fax: +49571 887-169
Email: info.de@wago.com | Web: www.wago.com

Do you have any questions about our products?
We are always happy to take your call at +49 (571) 887-44222.



Lower costs through fast commissioning and elimination of service expenses – solutions from WINSTA® MIDI

WINSTA® is the pluggable connection system that is perfectly tailored to the strict requirements of electrical installation. It allows error-free installation of cables and components, quickly and reliably. Choose durability and quality – the WINSTA® MIDI pluggable installation connector with locking lever from WAGO makes the installation of electrical components visibly easier.

- protection against mismatching eliminates errors
- for automation controllers
- with A coding for a great number of applications
- flexible installation to save space
- convenient installation and commissioning

Data

Electrical data

Ratings per IEC/EN

Ratings per	IEC/EN 60664-1
Nominal voltage (III/3)	250 V
Rated impulse voltage (III/3)	4 kV
Rated current	25 A
Legend (ratings)	(III / 3) ≙ Overvoltage category III / Pollution degree 3

Ratings per UL 1977

Note for the US market	Some versions may also be used for current interruption in accordance with the UL certificate in select applications with currents below 16 A and voltages up to 600 V. For further information, please contact your local sales office.
Rated voltage (UL 1977)	600 V
Rated current UL 1977	23 A

General

Note on contact resistance	approx. 1 mΩ of contact resistance approx. 0.25 mΩ contact transition plug/socket
----------------------------	--

Subject to changes. Please also observe the further product documentation!



Connection data

Total number of potentials	3
PE function	Preceding PE contact

Connection 1

Pole number	3
-------------	---

Physical data

Pin spacing	10 mm / 0.394 inches
Width	30 mm / 1.181 inches
Height	32.7 mm / 1.287 inches
Depth	51 mm / 2.008 inches

Mechanical Data

Application	General mains applications
Coding	A
Marking	L \perp N
Potential marking	L \perp N
Mating force of a plug-in connection	approx. 20 ... 70 N (depending on pole number)
Retention force of a plug-in connection	When locked: > 80 N
Unmating force of a plug-in connection	Unlocked: approx. 20 ... 70 N (depending on pole number)
Number of mating cycles	200, without resistive load
Type of distribution box	h-distribution connector, outputs on one side
Protection type	IP20; When mated: IP2xC (These compact connectors are not designed for use in open, easily accessible areas!)

Plug-in connection

Contact type (pluggable connector)	Socket/plug
Mismating protection	Yes
Note on mismating protection	All <i>WINSTA</i> [®] components are 100% protected against mismating when: a.) plugging different numbers of poles b.) plugging while rotated 180 c.) plugging while laterally staggered d.) plugging one pole
Locking lever	yes

Subject to changes. Please also observe the further product documentation!



Locking of plug-in connection

locking lever

Note on locking system

All connectors for mounted installations (snap-in versions for lighting fixtures or devices, all types of PCB and distribution connectors) are factory-equipped with locking levers to ensure plugs and sockets are securely locked. Additional locking levers are only required for flying leads (plug/socket).

Material Data

Note (material data)

Information on material specifications can be found here

Color	white
Insulation material	Polyamide (PA66)
Flammability class per UL94	V0
Contact material	Copper or copper alloy; surface-treated
Contact plating	Tin
Fire load	0.374 MJ
Weight	22.4 g

Environmental requirements

Processing temperature	-5 ... +40 °C
Continuous operating temperature	-35 ... +85 °C
Note on continuous operating temperature	Insulating parts for temperatures \leq 105 °C

Commercial data

eCl@ss 10.0	27-44-06-03
eCl@ss 9.0	27-44-06-03
ETIM 8.0	EC002567
ETIM 7.0	EC002567
PU (SPU)	50 pcs
Packaging type	box
Country of origin	DE
GTIN	4045454251567
Customs tariff number	85366990990



Environmental Product Compliance

RoHS Compliance Status	Compliant, No Exemption
------------------------	-------------------------

Subject to changes. Please also observe the further product documentation!

Approvals / Certificates



General approvals

Logo	Approval	Additional Approval Text	Certificate name
	CCA DEKRA Certification B.V.	EN 61535	71- 123228
	CCA DEKRA Certification B.V.	IEC 61535	NL -84761
	cURus Underwriters Laboratories Inc.	UL 1977	E45171

Declarations of conformity and manufacturer's declarations









Logo	Approval	Additional Approval Text	Certificate name
	EU-Declaration of Conformity WAGO GmbH & Co. KG	-	-

Approvals for marine applications

Logo	Approval	Additional Approval Text	Certificate name
	ABS American Bureau of Shipping	-	19- HG1868589- PDA
	DNV GL Det Norske Veritas, Germanischer Lloyd	-	TAE00001Z6
	LR Lloyds Register	IEC 61984	LR22429487TA

Subject to changes. Please also observe the further product documentation!



Counterpart

	Item no.770-123 Socket; with strain relief housing; 3-pole; Cod. A; 4,00 mm ² ; white	www.wago.com/770-123
	Item no.770-133 Plug; with strain relief housing; 3-pole; Cod. A; 4,00 mm ² ; white	www.wago.com/770-133
	Item no.770-223 Socket; 3-pole; Cod. A; 4,00 mm ² ; white	www.wago.com/770-223
	Item no.770-233 Plug; 3-pole; Cod. A; 4,00 mm ² ; white	www.wago.com/770-233
	Item no.770-233/035-050 Plug; with strain relief housing; 3-pole; Cod. A; 4,00 mm ² ; white	www.wago.com/770-233/035-050
	Item no.771-9993/106-102 pre-assembled connecting cable; Eca; Socket/open-ended; 3-pole; Cod. A; H05VV-F 3G 1.5 mm ² ; 1 m; 1,50 mm ² ; white	www.wago.com/771-9993/106-102
	Item no.771-9993/006-102 pre-assembled interconnecting cable; Eca; Socket/plug; 3-pole; Cod. A; H05VV-F 3G 1.5 mm ² ; 1 m; 1,50 mm ² ; white	www.wago.com/771-9993/006-102
	Item no.770-223/035-050 Socket; with strain relief housing; 3-pole; Cod. A; 4,00 mm ² ; white	www.wago.com/770-223/035-050
	Item no.771-9993/206-102 pre-assembled connecting cable; Eca; Plug/open-ended; 3-pole; Cod. A; H05VV-F 3G 1.5 mm ² ; 1 m; 1,50 mm ² ; white	www.wago.com/771-9993/206-102

Optional accessories

Cover

Cover

	Item no.: 770-360 Lockout cap; for plugs; 5-pole; separable; yellow	www.wago.com/770-360
	Item no.: 770-201 Lockout cap; 12-pole, separable; for sockets; Plastic; black	www.wago.com/770-201

Subject to changes. Please also observe the further product documentation!

Item no.: 770-221

Lockout cap; 12-pole, separable; for sockets; Plastic; white

www.wago.com/770-221

Mounting

Mounting accessories



Item no.: 770-623

Mounting plate; 3-pole; for distribution connectors; Plastic; black

www.wago.com/770-623



Item no.: 770-673

Mounting plate; 3-pole; for distribution connectors; Plastic; white

www.wago.com/770-673

Downloads

Documentation

Bid Text

770-684 X81 - Datei	2019 Feb 19	xml 2.8 kB	Download
770-684 doc - Datei	2015 Mar 12	doc 23.6 kB	Download
ausschreiben.de 770-684		URL	Download

CAD/CAE-Data

CAD data

2D/3D Models 770-684		URL	Download
----------------------	--	-----	----------

CAE data

EPLAN Data Portal 770-684		URL	Download
---------------------------	--	-----	----------

WSCAD Universe 770-684		URL	Download
------------------------	--	-----	----------

ZUKEN Portal 770-684		URL	Download
----------------------	--	-----	----------

Subject to changes. Please also observe the further product documentation!

WAGO GmbH & Co. KG
 Hansastr. 27
 32423 Minden
 Phone: +49571 887-0 | Fax: +49571 887-169
 Email: info.de@wago.com | Web: www.wago.com

Do you have any questions about our products?
 We are always happy to take your call at +49 (571) 887-44222.

Environmental Product Compliance

Compliance Search

Environmental Product Compliance 770-684

URL

Download

h-distribution connector; 3-pole; Cod. A; 1 input; 2 outputs; outputs on one side; 2 locking levers; white

Installation Notes

Installation

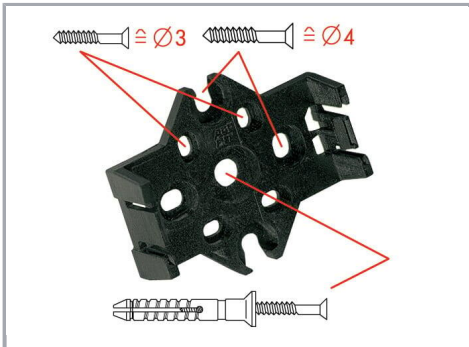

Mounting plates can be secured using commercially available screws or nail-drive anchors.



The distribution connectors snap together when attached to the mounting plate.



To release the distribution connector, unlock the latch using a screwdriver.

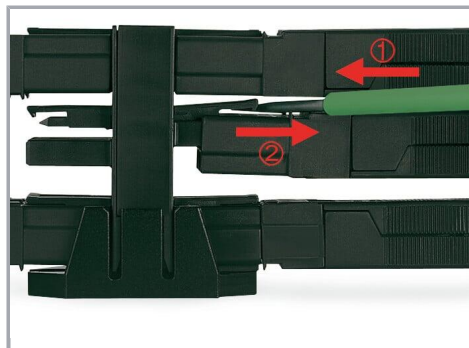

All distribution connector connections are locked and protected against accidental disconnection directly after mating. Locking of any connection is released using a screwdriver, even if all connections are used.

Product family

WINSTA® MIDI

Subject to changes. Please also observe the further product documentation!

WAGO GmbH & Co. KG

Hansastr. 27

32423 Minden

Phone: +49571 887-0 | Fax: +49571 887-169

Email: info.de@wago.com | Web: www.wago.com

Do you have any questions about our products?

We are always happy to take your call at +49 (571) 887-44222.



[Show all products from the family](#)

Subject to changes. Please also observe the further product documentation!

WAGO GmbH & Co. KG
Hansastr. 27
32423 Minden
Phone: +49571 887-0 | Fax: +49571 887-169
Email: info.de@wago.com | Web: www.wago.com

Do you have any questions about our products?
We are always happy to take your call at +49 (571) 887-44222.