



ANTENNA TECHNOLOGIES LIMITED COMPANY

## PRODUCTS CATALOG

*Antenna Technologies Limited Company (ATLC) delivers a large selection of antennas including directional and OMNI directional designs. In particular, ATLC offers a wide variety of antenna solutions for spread spectrum applications. Every antenna is factory tested prior to shipment and is guaranteed to meet or exceed our specifications. ATLC also offers OEM custom antenna design, consulting, and manufacturing services.*



## Table of Contents

Omnidirectional Antennas VHF Low Band .....	1
Omnidirectional Antennas VHF Band .....	2
Omnidirectional Antennas 200 MHz Series .....	3
Omnidirectional Antennas 400 MHz Series .....	4
Omnidirectional Antennas 700 MHz Series .....	5
Omnidirectional Antennas 800 MHz Series .....	6
Omnidirectional Antennas 900 MHz Series .....	7
Omnidirectional Antennas 902 MHz Series .....	8
Omnidirectional Antennas 1.9 GHz and 2.4 GHz Series .....	9
Omnidirectional Antennas 5.8 GHz Series .....	10
800 MHz Microcell Hemi Antennas .....	11
900 MHz Microcell Hemi Antennas .....	12
2.4 GHz Microcell Hemi Antennas .....	13
Dual Frequency Microcell Hemi Antennas.....	14
Dual Frequency Microcell Hemi Antennas - <i>continued</i> .....	15
Low Profile Disc Antennas.....	16
Low Profile “Disc” Antennas 2.4 GHz Series .....	17
Low Profile Dual Band Antennas.....	18
Low Profile Tri-Band Antenna .....	19
“LoPro” Antennas .....	20
Low Profile Dual Band Public Safety Antennas .....	21
PCD Subscriber Series Antennas .....	22
Yagi Antennas VHF Series .....	23
Yagi Antennas 200 MHz Series.....	24
Yagi Antennas 300 MHz Series.....	25
Yagi Antennas UHF Series .....	26
Yagi Antennas 700 MHz Series.....	27
Enviro-Sealed Protect Yagi Antennas 700 MHz Series .....	28
Yagi Antennas 800 MHz Series.....	29
Enviro-Sealed Protect Yagi Antennas 800 MHz Series .....	30
Yagi Antennas 900 MHz Series.....	31
Enviro-Sealed Protect Yagi Antennas 900 MHz .....	32
Yagi Antennas 902 MHz Series.....	33
Enviro-Sealed Protect Yagi Antenna 902 MHz Series .....	34
2.4 GHz Directional Antennas .....	35





ANTENNA TECHNOLOGIES LIMITED COMPANY

5.8 GHz Directional Antennas .....	36
Custom FM Broadcast Antennas.....	37
TV/CATV Receiving Antennas .....	37
Dipole Array Antennas .....	37
Yagi antennas VHF Low Band.....	38
FLEXTRON Portable Communication Antennas .....	38
Base Station Antennas 2.4 GHz.....	39
Base Station Antennas 5 GHz.....	40
Base Station Antennas Dual Bands .....	40
Hardware Mounting Systems .....	41
Cable Assemblies .....	41
Mechanical Power Divider (with “N” male connectors) .....	42
Mechanical Power Divider (with “N” female connectors).....	42
Yagi Coaxial Power Divider.....	43
ATLC Philosophy.....	44

## Omnidirectional Antennas VHF Low Band

These rugged unity gain OMNIs are optimized for wide bandwidth performance in the lower portion of the VHF Band. The broad vertical beamwidth provides wide area coverage. No field tuning is required to obtain maximum performance.

### Key Features

-  Heavy duty aluminum structure provides superior performance and exception weather resistance
-  Flexible Feed line with N Female termination simplifies the final installation
-  Stainless steel B-Bolts and custom V-Blocks for easy and secure mounting

Individually factory tested  
**MADE IN THE USA**

Top View Set

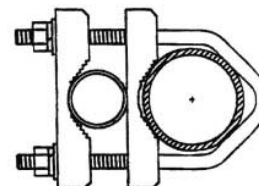



Specifications	Model V400	Model V700
Frequency Range, MHz	30-50, specify center frequency	50-80, specify center frequency
Gain, dBd	Unity	Unity
VSWR (50 Ohms) 1.5:1 Bandwidth, MHz	1.2:1 typical 2 minimum	1.2:1 typical 2 minimum
3 dB Beamwidth, E/H Planes	90/360°	79/360°
Maximum Power, watts	250	250
Termination	Pigtail N Female	Pigtail N Female
Polarization	Vertical	Vertical
Overall Length, feet (m)	Min: 10 (3) Max: 18 (5.5) depending on frequency	Min: 10 (3) Max: 18 (5.5) depending on frequency
Element Material	1.0" OD; Aluminum	1.0" OD; Aluminum
Mast Diameter, inches (cm)	1.25-2.00 (3.2-5.1)	1.25-2.00 (3.2-5.1)
Mounting Hardware	Base to Mast, Supplied	Base to Mast, Supplied
Wind Surface Area, feet <sup>2</sup>	.39 (.036)	.39 (.036)
Wind Survival, mph (kph)	100 (160)	100 (160)
Weight, pounds (kg)	5.0 (2.27)	5.0 (2.27)

\* Limited by feedline. Higher power ratings are available as an option.

## Omnidirectional Antennas VHF Band

These rugged unity gain OMNIs are optimized for wide bandwidth performance in the lower portion of the VHF Band. The broad vertical beamwidth provides wide area coverage. No field tuning is required to obtain maximum performance

### Key Features

-  Encased in a heavy wall fiberglass radome for superior weather resistance
-  Flexible Feed line with N Female termination simplifies the final installation
-  Stainless steel B-Bolts and custom V-Blocks for easy and secure mounting

Individually factory tested  
**MADE IN THE USA**

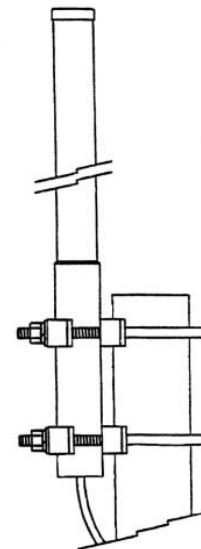
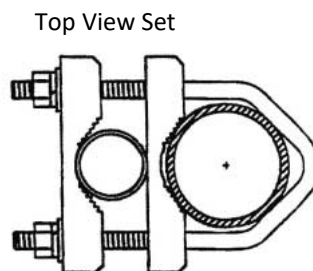



Specifications	Model V1500	Model V1600WB
Frequency Range, MHz	144-174, specify center frequency	148-174
Gain, dBd	Unity	Unity
VSWR (50 Ohms) 1.5:1 Bandwidth, MHz	1.2:1 typical 3 minimum	1.2:1 typical 26 minimum
3 dB Beamwidth, E/H Planes	90/360°	90/360°
Maximum Power, watts	150*	150*
Termination	Pigtail N Female	Pigtail N Female
Polarization	Vertical	Vertical
Overall Length, feet (m)	5 (1.5)	5 (1.5)
Radome Material	1.0" OD; .125" wall Fiberglass	1.0" OD; .125" wall Fiberglass
Element Material	All-Brass Components	All-Brass Components
Mast Diameter, inches (cm)	1.25-2.25 (3.2-5.7)	1.25-2.00 (3.2-5.1)
Mounting Hardware	Base to Mast, Supplied	Base to Mast, Supplied
Wind Surface Areas, feet <sup>2</sup>	.37 (.03)	.37 (.03)
Wind Survival, mph (kph)	125 (200)	125 (200)
Weight, pounds (kg)	4.0 (1.8)	4.0 (1.8)

\* Limited by feedline. Higher power ratings are available as an option.

## Omnidirectional Antennas 200 MHz Series

These rugged unity gain OMNIs are optimized for wide bandwidth performance in the lower portion of the VHF Band. The broad vertical beamwidth provides wide area coverage. No field tuning is required to obtain maximum performance

### Key Features

-  Encased in a heavy wall fiberglass radome for superior weather resistance
-  Flexible Feed line with N Female termination simplifies the final installation
-  Stainless steel B-Bolts and custom V-Blocks for easy and secure mounting

Individually factory tested  
**MADE IN THE USA**

Top View Set

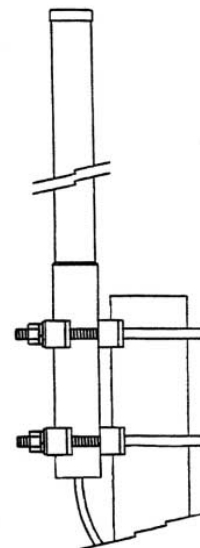
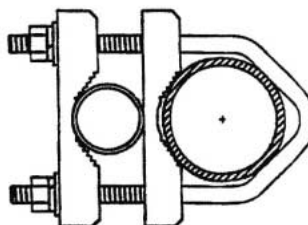



Specifications	Model V2200
Frequency Range, MHz	218-222, specify center frequency
Gain, dBd	Unity
VSWR (50 Ohms) 1.5:1 Bandwidth, MHz	1.2:1 typical 4 minimum
3 dB Beamwidth, E/H Planes	77/360°
Maximum Power, watts	150*
Termination	Pigtail N Female
Polarization	Vertical
Overall Length, feet (m)	4 (1.22)
Radome Material	1.0" OD; .125" wall Fiberglass
Element Material	All-Brass Components
Mast Diameter, inches (cm)	1.25-2.00 (3.2-5.1)
Mounting Hardware	Base to Mast, Supplied
Wind Surface Area, feet <sup>2</sup>	.245 (.023)
Wind Survival, mph (kph)	125 (200)
Weight, pounds (kg)	3.0 (1.4)

\* Limited by feedline. Higher power ratings are available as an option.

## Omnidirectional Antennas 400 MHz Series

These unity gain OMNIs are specifically optimized for communications in the 400 MHz band and feature broad beamwidth to wide area coverage. Excellent choice for security monitoring or data collection applications

### Key Features

-  Due to its compact size, the antenna is ideal for pole mounting or portable operations
-  The all brass center feed is encased in a heavy-wall fiberglass radome for a clean radiation pattern and superior strength
-  Antenna incorporates a flexible pigtail termination and all stainless-steel hardware for quick and easy installation

Individually factory tested  
**MADE IN THE USA**

Top View Set

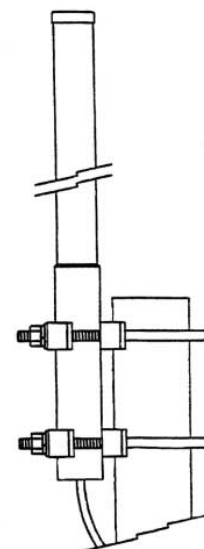
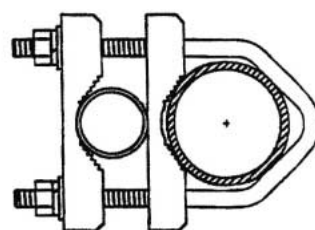



Specifications	Model V4100	Model V4400	Model V4600	Model V4800
Frequency Range, MHz	406-430	430-450	450-470	470-490
Gain, dBd	Unity	Unity	Unity	Unity
VSWR (50 Ohms) 1.5:1 Bandwidth, MHz	1.2:1 typical 14 minimum	1.2:1 typical 13 minimum	1.2:1 typical 20 minimum	1.2:1 typical 20 minimum
3 dB Beamwidth, E/H	77/360°	77/360°	77/360°	77/360°
Maximum Power, watts	100*	100*	100*	100*
Termination	Pigtail N Female	Pigtail N Female	Pigtail N Female	Pigtail N Female
Polarization	Vertical	Vertical	Vertical	Vertical
Overall Length, inches (cm)	24 (61)	24 (61)	24 (61)	24 (61)
Radome Material	Fiberglass	Fiberglass	Fiberglass	Fiberglass
Element Material	Brass	Brass	Brass	Brass
Mast Diameter, inches (cm)	1.25-2.00 (3.2-5.1)	1.25-2.00 (3.2-5.1)	1.25-2.00 (3.2-5.1)	1.25-2.00 (3.2-5.1)
Mounting Hardware	Base to Mast, Supplied	Base to Mast, Supplied	Base to Mast, Supplied	Base to Mast, Supplied
Wind Surface Areas,	.14 (.013)	.14 (.013)	.14 (.013)	.14 (.013)
Wind Survival, mph (kph)	125 (200)	125 (200)	125 (200)	125 (200)
Weight, pounds (kg)	2.0 (.9)	2.0 (.9)	2.0 (.9)	2.0 (.9)

\* Limited by feedline. Higher power ratings are available as an option.

## Omnidirectional Antennas 700 MHz Series

This rugged unit gain MONI is specifically optimized for wide bandwidth all weather performance. The broad vertical beamwidth provides wide area coverage. No field tuning is required to obtain maximum performance.

### Key Features

-  Encased in a heavy wall fiberglass radome for superior weather resistance
-  Flexible Feed line with N Female termination simplifies the final installation
-  Stainless steel B-Bolts and custom V-Blocks for easy and secure mounting

Individually factory tested  
**MADE IN THE USA**

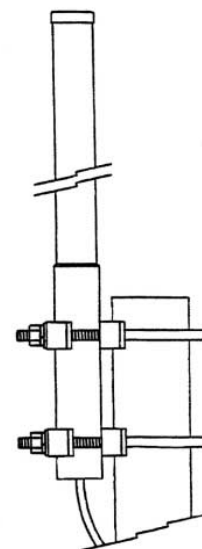
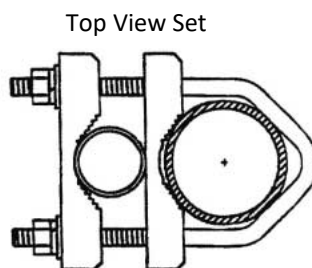

Specifications	Model V7770
Frequency Range, MHz	740-800
Gain, dBd	Unity
VSWR (50 Ohms) 1.5:1 Bandwidth, MHz	1.5:1 typical 60 minimum
3 dB Beamwidth, E/H Planes,	77/360°
Maximum Power, watts	50*
Termination	Pigtail N Female
Polarization	Vertical
Overall Length, inches	16
Radome Material	1.0" OD; .125" wall Fiberglass
Element Material	All-Brass Components
Mast Diameter, inches (cm)	1.25-2.00 (3.2-5.1)
Mounting Hardware	Base to Mast, Supplied
Wind Surface Area, feet <sup>2</sup>	.071 (.007)
Wind Survival, mph (kph)	150 (240)
Weight, pounds (kg)	1.5 (.68)



\* Limited by feedline. Higher power ratings are available as an option.



## Omnidirectional Antennas 800 MHz Series

These unity gain OMNIs are specifically optimized wide bandwidth, all-weather performance. The broad vertical beamwidth provides wide area coverage. No field tuning is required to obtain maximum performance

### Key Features

-  Encased in a heavy wall fiberglass radome for superior weather resistance
-  Flexible Feed line with N Female termination simplified
-  Stainless steel V-Bolts and custom V-Blocks for easy and secure mounting

Individually factory tested  
**MADE IN THE USA**

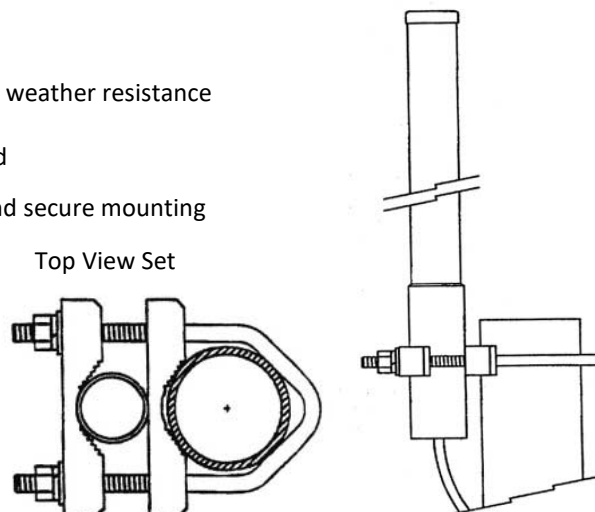



Specifications	Model V8350	Model V8600
Frequency Range, MHz	806-866	824-896
Gain, dBd	Unity	Unity
VSWR (50 Ohms) 1.5:1 Bandwidth, MHz	1.2:1 typical 60 minimum	1.2:1 typical 72 minimum
3 dB Beamwidth, E/H	77/360°	77/360°
Maximum Power, watts	50*	50*
Termination	Pigtail N Female	Pigtail N Female
Polarization	Vertical	Vertical
Overall Length, inches (cm)	12(30.5)	12 (30.5)
Radome Material	1.0"OD; .125" wall Fiberglass	1.0"OD; .125" wall Fiberglass
Element Material	All-Brass Components	All-Brass Components
Mast Diameter, inches (cm)	1.25-2.00 (3.2-5.1)	1.25-2.00 (3.2-5.1)
Mounting Hardware	Base to Mast, Supplied	Base to Mast, Supplied
Wind Surface Areas, feet <sup>2</sup>	.071 (.007)	.071 (.007)
Wind Survival, mph (kph)	150 (240)	150 (240)
Weight, pounds (kg)	1.5 (.68)	1.5 (.68)

\* Limited by feedline. Higher power ratings are available as an option.

## Omni-directional Antennas 900 MHz Series

This rugged unity gain OMNI is specially optimized for wide bandwidth all weather performance. The broad vertical beamwidth provides wide area coverage. No field tuning is required to obtain maximum performance

### Key Features

-  Encased in a heavy wall fiberglass radome for superior weather resistance
-  Flexible Feed line with N Female termination simplifies the final installation
-  Stainless steel V-Bolts and custom V-Blocks for easy and secure mounting

Individually factory tested  
**MADE IN THE USA**

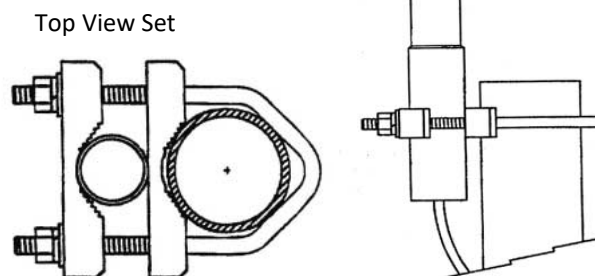



Specifications	Model V9440
Frequency Range, MHz	928-960
Gain, dBd	Unity
VSWR (50 Ohms) 1.5:1 Bandwidth, MHz	1.2:1 typical 32 minimum
3 dB Beamwidth, E/H Planes	77/360°
Maximum Power, watts	50*
Termination	Pigtail N Female
Polarization	Vertical
Overall Length, inches (cm)	12(30.5)
Radome Material	1.0" OD; .125" wall Fiberglass
Element Material	All-Brass Components
Mast Diameter, inches (cm)	1.25-2.00 (3.2-5.1)
Mounting Hardware	Base to Mast, Supplied
Wind Surface Area, feet <sup>2</sup>	.071 (.007)
Wind Survival, mph (kph)	150 (240)
Weight, pounds (kg)	1.5 (.68)

\* Limited by feedline. Higher power ratings are available as an option.

## Omni-directional Antennas 902 MHz Series

These rugged OMNIs are optimized for wide bandwidth, all weather performance. The broad vertical beamwidth provides wide area coverage. No field tuning is required to obtain maximum performance

### Key Features

-  Encased in a heavy wall fiberglass radome for superior weather resistance
-  Flexible Feed line with N Female termination simplifies the final installation
-  Stainless steel V-Bolts and custom V-Blocks for easy and secure mounting

Individually factory tested  
**MADE IN THE USA**

Top View Set

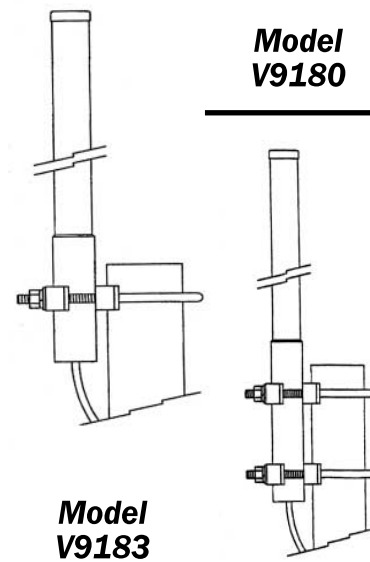
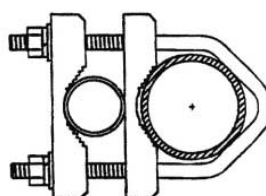



Specifications	Model V9180	Model V9183
Frequency Range, MHz	902-928	902-928
Gain, dBd	Unity	3
VSWR (50 Ohms) 1.5:1 Bandwidth, MHz	1.2:1 typical 26 minimum	1.5:1 typical 26 minimum
3 dB Beamwidth, E/H Planes	77/360°	33/360°
Maximum Power, watts	50*	50*
Termination	Pigtail N Female	Pigtail N Female
Polarization	Vertical	Vertical
Overall Length, inches	12	30
Radome Material	1.0" OD; .125" wall Fiberglass	1.0" OD; .125" wall Fiberglass
Element Material	All-Brass Components	All-Brass Components
Mast Diameter, inches (cm)	1.25-2.00 (3.2-5.1)	1.25-2.00 (3.2-5.1)
Mounting Hardware	Base to Mast, Supplied	Base to Mast, Supplied
Wind Surface Area, feet <sup>2</sup>	.071 (.007)	.14 (.007)
Wind Survival, mph (kph)	150 (240)	150 (240)
Weight, pounds (kg)	1.5 (.68)	2.0 (.9)

\* Limited by feedline. Higher power ratings are available as an option.

## Omnidirectional Antennas 1.9 GHz and 2.4 GHz Series

These unity gain OMNIs are specifically optimized for communications in the 1.9 and 2.4 GHz band and feature broad beamwidth for wide area coverage. Excellent choice for security monitoring or data collection applications.

### Key Features

-  Encased in a heavy wall fiberglass radome for superior weather resistance
-  Flexible Feed line with N Female termination simplifies the final installation
-  Stainless steel V-Bolts and custom V-Blocks for easy and secure mounting

Individually factory tested  
**MADE IN THE USA**

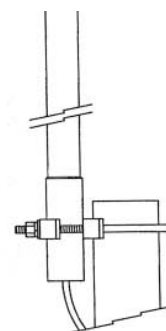
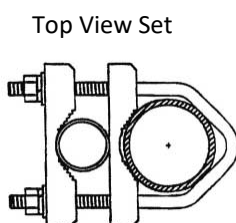

**Models**

**VG1900,  
VG2400,  
VG2403**

**Model**

**VG2408**







Specifications	Model VG1900	Model VG2400	Model VG2403	Model VG2408
Frequency Range, MHz	1850-1990	2400-2500	2400-2500	2400-2500
Gain, dBd	Unity	Unity	3	8 dBi
VSWR (50 Ohms) 1.5:1 Bandwidth, MHz	1.2:1 typical 140 minimum	1.2:1 typical 100 minimum	1.2:1 typical 85 minimum	1.5:1 typical 20 minimum
3 dB Beamwidth, E/H	77/360°	77/360°	40/360°	18/360°
Maximum Power, watts	30*	30*	30*	10
Termination	Pigtail N	Pigtail N	Pigtail N Female	N Female, Bottom Feed
Polarization	Vertical	Vertical	Vertical	Vertical
Overall Length, inches (cm)	12 (30.5)	12 (30.5)	12 (30.5)	17 (43.2)
Radome Material	1.0" OD; .125" wall Fiberglass	1.0" OD; .125" wall Fiberglass	1.0" OD; .125" wall Fiberglass	ASA with UV Protection
Element Material	Brass	Brass	Brass	Printed circuit board
Mast Diameter, inches (cm)	1.25-2.00 (3.2-5.1)	1.25-2.00 (3.2-5.1)	1.25-2.00 (3.2-5.1)	1.0 (2.5)
Mounting Hardware	Base to Mast, Supplied	Base to Mast, Supplied	Base to Mast, Supplied	Galvanized Steel
Wind Surface Areas, feet <sup>2</sup>	.071 (.007)	.071 (.007)	.071 (.007)	n/a
Wind Survival, mph (kph)	150 (240)	150 (240)	150 (240)	125 (200)
Weight, pounds (kg)	1.5 (.68)	1.5 (.68)	1.5 (.68)	1.0 (.5)

\* Limited by feedline. Higher power ratings are available as an option.

## Omnidirectional Antennas 5.8 GHz Series

This 8 dBd OMNI is specially optimized for communications in the 5.1-5.8 GHz band. The VG-5808 provides high gain and wide bandwidth with no field tuning required to obtain maximum performance. The micro strip collinear patch array element provides a clean radiation pattern

### Key Features

-  Ideal antenna for OEM applications
-  Bulkhead connector allows quick indoor or outdoor deployment
-  ABS plastic UV stabilized radome ensures quality performance in all deployments
-  802.11a compliant

**MADE IN THE USA**





Specifications	Model VG5808
Frequency Range, MHz	5100-5800
Gain, dBd	8
VSWR (50 Ohms) 1.5:1 Bandwidth, MHz	2:1 typical 10
3 dB Beamwidth, E/H Planes, °	10/360°
Maximum Power, watts	10*
Termination	SMA Female, Bottom Feed
Polarization	Vertical, Linear
Overall Length, inches (cm)	17 (43.18)
Radome Material	Polycarbonate
Element Material	Micro Strip
Mast Diameter, inches (cm)	.75 (1.905)
Mounting Hardware	Base to Mast, Supplied
Wind Survival, mph	75
Weight, pounds	1.0

\* Limited by feedline. Higher power ratings are available as an option.

## 800 MHz Microcell Hemi Antennas

The ATLC Hemi antenna provides superior and unequalled in building coverage in an aesthetically pleasing low profile package. Available in circular or linear polarization, single or dual frequency, choose the ATLC Hemi that is best suited for your installation.

### Key Features

-  Measuring just 2.42 inches in height and 5.4 inches in width, with a base diameter of 7.06 inches
-  Superior radiation pattern for large rooms, hallways and warehouses
-  Disguised radomes for an aesthetically pleasing appearance

**MADE IN THE USA**



Specifications	H835	H865	HE835	HE865	HLDP833
Frequency Range, MHz	806-866	824-896	806-866	824-896	806-866
Gain, dBi	4	4	4	4	2
Front to Back Ratio	9 dB	9 dB	9 dB	9 dB	6 dB
VSWR	2:1	2:1	2:1	2:1	2:1
1.5:1 Bandwidth, MHz	60	72	60	72	60
3 dB Beamwidth (E/H)	150/150	150/150	150/150	150/150	175/175
Maximum Power, Watts	50	50	50	50	50
Termination	Pigtail N Female	Pigtail N Female	Pigtail N Female	Pigtail N Female	Pigtail N Female
Polarization	Right Hand Circular	Right Hand Circular	Left Hand Circular	Left Hand Circular	Linear



Specifications	HLDP863	HLDPV833	HLDPV863	HLDPH833	HLDPH863
Frequency Range, MHz	824-896	806-866	824-896	806-866	824-896
Gain, dBi	2	2	2	2	2
Front to Back Ratio	6 dB	6 dB	6 dB	6 dB	6 dB
VSWR	2:1	2:1	2:1	2:1	2:1
1.5:1 Bandwidth, MHz	72	60	72	60	72
3 dB Beamwidth (E/H)	175/175	175/175	175/175	175/175	175/175
Maximum Power, Watts	50	50	50	50	50
Termination	Pigtail N Female	Pigtail N Female	Pigtail N Female	Pigtail N Female	Pigtail N Female
Polarization	Linear	Linear Vertical	Linear Vertica	Linear Horizontal	Linear Horizontal

For side exit, please add SE to model number. For example, H835SE

## 900 MHz Microcell Hemi Antennas

The ATLC Hemi antenna provides superior and unequalled in building coverage in an aesthetically pleasing low profile package. Available in circular or linear polarization, single or dual frequency, choose the ATLC Hemi that is best suited for your installation.

### Key Features

-  Measuring just 2.42 inches in height and 5.4 inches in width, with a base diameter of 7.06 inches
-  Superior radiation pattern for large rooms, hallways and warehouses
-  Disguised radomes for an aesthetically pleasing appearance

**MADE IN THE USA**



Specifications	H925	H915	HE925	HE915	HLD923
Frequency Range, MHz	890-960	902-928	890-960	902-928	890-960
Gain, dBi	4	4	4	4	2
Front to Back Ratio	9 dB	9 dB	9 dB	9 dB	6 dB
VSWR	2:1	2:1	2:1	2:1	2:1
1.5:1 Bandwidth, MHz	70	26	70	26	70
3 dB Beamwidth (E/H)	150/150	150/150	150/150	150/150	175/175
Maximum Power, Watts	50	50	50	50	50
Termination	Pigtail N Female	Pigtail N Female	Pigtail N Female	Pigtail N Female	Pigtail N Female
Polarization	Right Hand Circular	Right Hand Circular	Left Hand	Left Hand	Linear

Specifications	HLD913	HLD923	HLD933	HLD943	HLD953
Frequency Range, MHz	902-928	890-960	902-928	890-960	902-928
Gain, dBi	2	2	2	2	2
Front to Back Ratio	6 dB	6 dB	6 dB	6 dB	6 dB
VSWR	2:1	2:1	2:1	2:1	2:1
1.5:1 Bandwidth, MHz	26	70	26	70	26
3 dB Beamwidth (E/H)	175/175	175/175	175/175	175/175	175/175
Maximum Power, Watts	50	50	50	50	50
Termination	Pigtail N Female	Pigtail N Female	Pigtail N Female	Pigtail N Female	Pigtail N Female
Polarization	Linear	Linear	Linear	Linear	Linear

For side exit, please add SE to model number. For example, H925SE

## 2.4 GHz Microcell Hemi Antennas

These low profile, high performance MicroCell Antennas are ideal for PCS and 2.4 GHz wireless LAN applications. MicroCell antennas allow for reliable RF coverage in large areas. With elliptical polarization to minimize the losses typically associated with cross-polarization.

### Key Features

- Hemispherical coverage
- Superior radiation pattern for large rooms, hallways and warehouses
- Disguised radomes for an aesthetically pleasing appearance

**MADE IN THE USA**



Specifications	Model H1905	Model H2405	Model HDP2405*
Frequency Range, MHz	1850-2000	2375-2500	2375-2500
Gain, dBi	5	5	5
Front to Back Ratio, dB	12	12	12
VSWR (50 Ohms) 1.5:1 Bandwidth, MHz	1.2:1 typical 150	1.2:1 typical 125	1.2:1 typical 125
3 dB Beamwidth, E/H	360/120°	360/120°	70/120°
Maximum Power, watts	25	25	25
Termination	Pigtail N Female	Pigtail N Female	Pigtail N Female
Polarization	Elliptical	Elliptical	Elliptical
Radome Size, L x W x H, inches	5 x 5 x 3.5	5 x 5 x 3.5	5 x 5 x 3.5
Weight, pounds (kg)	.75 (.34)	.75 (.34)	.75 (.34)

\* Vertical and Horizontal Polarization, Separate Pigtails.

For side exit, please add SE to model number. For example, H1905SE



## Dual Frequency Microcell Hemi Antennas

The ATLC Hemi antenna provides superior and unequalled in building coverage in an aesthetically pleasing low profile package. Available in circular or linear polarization, single or dual frequency, choose the ATLC Hemi that is best suited for your installation.

### Key Features

- Measuring just 2.42 inches in height and 5.4 inches in width, with a base diameter of 7.06 inches
- Superior radiation pattern for large rooms, hallways and warehouses
- Disguised radomes for an aesthetically pleasing appearance

**MADE IN THE USA**



Specifications	HDF86195	HDF83195	HDF91195	HDF92195
Frequency Range, MHz	824-896 1850-1990	806-866 1850-1990	902-928 1850-1990	890-960 1850-1990
Gain, dBi	4	4	4	4
Front to Back Ratio	9 dB	9 dB	9 dB	9 dB
VSWR	2:1	2:1	2:1	2:1
1.5:1 Bandwidth, MHz	72/140	60/140	26/140	70/140
3 dB Beamwidth (E/H)	150/150	150/150	150/150	150/150
Maximum Power, Watts	50	50	50	50
Termination	Pigtail N Female	Pigtail N Female	Pigtail N Female	Pigtail N Female
Polarization	Circular	Circular	Circular	Circular

Specifications	HDFE86195	HDFE83195	HDFE91195	HDFE92195
Frequency Range, MHz	824-896 1850-1990	806-866 1850-1990	902-928 1850-1990	890-960 1850-1990
Gain, dBi	4	4	4	4
Front to Back Ratio	9 dB	9 dB	9 dB	9 dB
VSWR	2:1	2:1	2:1	2:1
1.5:1 Bandwidth, MHz	72/140	60/140	26/140	70/140
3 dB Beamwidth (E/H)	150/150	150/150	150/150	150/150
Maximum Power, Watts	50	50	50	50
Termination	Pigtail N Female	Pigtail N Female	Pigtail N Female	Pigtail N Female
Polarization	Left Hand Circular	Left Hand	Left Hand	Left Hand

For side exit, please add SE to model number. For example, HDF86195SE

Dual Frequency Microcell Hemi Antennas - *continued*

Specifications	HLDFDP86193	HLDFDP83193	HLDFDP91193	HLDFDP92193
Frequency Range, MHz	824-896 1850-1990	806-866 1850-1990	902-928 1850-1990	890-960 1850-1990
Gain, dBi	2	2	2	2
Front to Back Ratio	6 dB	6 dB	6 dB	6 dB
VSWR	2:1	2:1	2:1	2:1
1.5:1 Bandwidth, MHz	72/140	60/140	26/140	70/140
3 dB Beamwidth (E/H)	175/175	175/175	175/175	175/175
Maximum Power, Watts	50	50	50	50
Termination	Pigtail N Female	Pigtail N Female	Pigtail N Female	Pigtail N Female
Polarization	Dual Linear	Dual Linear	Dual Linear	Dual Linear

Specifications	HLDFDPV86193	HLDFDPV83193	HLDFDPV91193	HLDFDPV92193
Frequency Range, MHz	824-896 1850-1990	806-866 1850-1990	902-928 1850-1990	890-960 1850-1990
Gain, dBi	2	2	2	2
Front to Back Ratio	17 dB	17 dB	17 dB	17 dB
VSWR	2:1	2:1	2:1	2:1
1.5:1 Bandwidth, MHz	72/140	60/140	26/140	70/140
3 dB Beamwidth (E/H)	175/45	175/45	175/45	175/45
Maximum Power, Watts	50	50	50	50
Termination	Pigtail N Female	Pigtail N Female	Pigtail N Female	Pigtail N Female
Polarization	Linear Vertical	Linear Vertical	Linear Vertical	Linear Vertical

Specifications	HLDFDPH86193	HLDFDPH83193	HLDFDPH91193	HLDFDPH92193
Frequency Range, MHz	824-896 1850-1990	806-866 1850-1990	902-928 1850-1990	890-960 1850-1990
Gain, dBi	2	2	2	2
Front to Back Ratio	17 dB	17 dB	17 dB	17 dB
VSWR	2:1	2:1	2:1	2:1
1.5:1 Bandwidth, MHz	72/140	60/140	26/140	70/140
3 dB Beamwidth (E/H)	175/45	175/45	175/45	175/45
Maximum Power, Watts	50	50	50	50
Termination	Pigtail N Female	Pigtail N Female	Pigtail N Female	Pigtail N Female
Polarization	Linear Horizontal	Linear Horizontal	Linear Horizontal	Linear Horizontal

For side exit, please add SE to model number. For example, HLDFDP86193SE

## Low Profile Disc Antennas

Low Profile Antennas offer a low profile, sleek design with broadband performance. Designed for both indoor and outdoor use, the low profile antennas are easy to install with an adhesive mount.

### Key Features

- Broadband performance
- Black and white radomes available
- Adhesive backed base mounting plate included

**MADE IN THE USA**



**Azimuth Pattern**

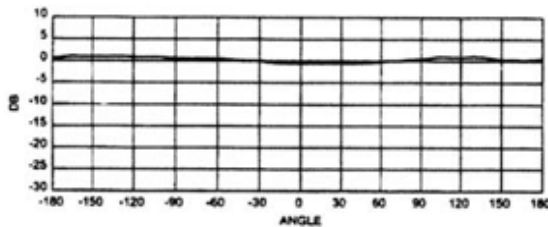

**Elevation Pattern**

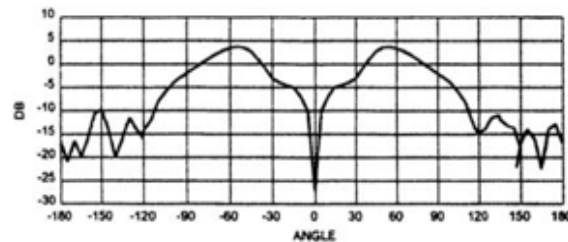



Specifications	Model LP83	Model LP86	Model LP91	Model LP92
Frequency Range, MHz	806-866	824-896	902-928	890-960
Element Type	Edge Slot	Edge Slot	Edge Slot	Edge Slot
Gain, dBi	3	3	3	3
VSWR (@ resonance)	1.5:1	1.5:1	1.5:1	1.5:1
Azimuth Beamwidth	OMNIdirectional	OMNIdirectional	OMNIdirectional	OMNIdirectional
Elevation Beamwidth	Cosine	Cosine	Cosine	Cosine
Maximum Power, watts	50	50	50	50
Impedance	50 Ohms	50 Ohms	50 Ohms	50 Ohms
Polarization	Vertical	Vertical	Vertical	Vertical
Termination	Pigtail N Female	Pigtail N Female	Pigtail N Female	Pigtail N Female
Temperature	-40° F to +160°F	-40° F to +160°F	-40° F to +160°F	-40° F to +160°F
Dimensions, inches	3.0" Diameter Top, 4.5" Diameter Base, .62" Height			
Weight, pounds	< 1 lb.	< 1 lb.	< 1 lb.	< 1 lb.

\* Other connector styles available. See page 41 for details.

## Low Profile "Disc" Antennas 2.4 GHz Series

The Low Profile Series OMNI-Directional Antennas provide discrete solutions for in-building and mobile 802.11 coverage, wireless inventory analysis and meter-reading applications. The antennas feature rugged UV-stable radomes and are available with a variety of custom connector configurations.

### Key Features

-  **Broadband performance**
-  **Easy to mount**
-  **Designed for indoor and outdoor use**

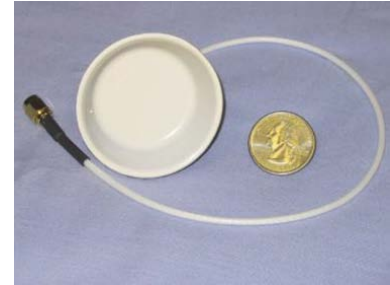

**MADE IN THE USA**

**Azimuth Pattern**

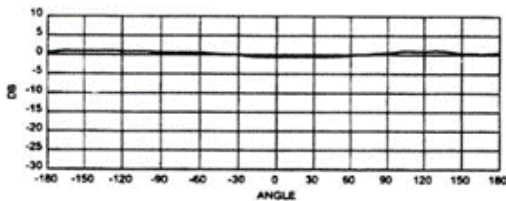

**Elevation Pattern**

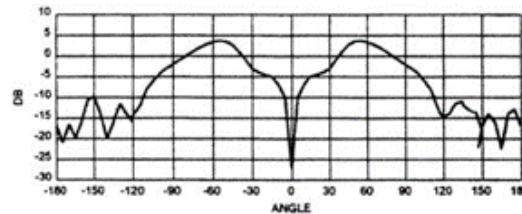

Specifications	Model LP19	Model LP24
Frequency Range, MHz	1850-1990	2400-2500
Element Type	Edge Slot	Edge Slot
Gain, dBi	3	3
VSWR (@ resonance )	1.5:1	1.5:1
Azimuth Beamwidth	OMNIdirectional	OMNIdirectional
Elevation Beamwidth	Cosine	Cosine
Maximum Power, watts	50	50
Impedance	50 Ohms	50 Ohms
Polarization	Vertical	Vertical
Termination	Pigtail SMA	Pigtail SMA
Temperature	-40° F to +160°F	-40° F to +160°F
Dimensions, inches	1.75" Diameter Top, 2.1" Diameter Base, 0.4" Height	1.75" Diameter Top, 2.1" Diameter Base, 0.4" Height
Weight, pounds	< 1 lb.	< 1 lb.

## Low Profile Dual Band Antennas

Low Profile Antennas offer a low profile, sleek design with broadband performance in the AMPS/Cellular/PCS bands. Designed for both indoor and outdoor use, the LP antennas are easy to mount.

### Key Features

- Broadband performance
- Black or white radomes available
- Adhesive backed base mounting plate included

**MADE IN THE USA**



<b>General Specifications</b>	
Maximum Power: 50 watts	Polarization: Vertical
Termination: Pigtail*	Antenna Dimensions: 4.50" OD x 1.06" H
Radome Material: UV Stable Polypropylene	Adhesive Gasket: 3M VHB Series Two-Sided
Gain: 3/3dBi	VSWR: 1.5:1 (@ resonance)
Azimuth Beamwidth: OMNIdirectional	Elevation Beamwidth: Cosine
Element Type: Edge Slot	Operating Temperature: -30° C to + 70° C

\* Specify connector style. See page 41 for details.

<b>Model Number</b>	<b>Frequency / MHz</b>
LP8319	806-866 / 1850-1990
LP8615	824-896 / GPS
LP8619	824-896 / 1850-1990
LP8619	902-928 / 1850-1990
LP9219	890-960 / 1850-1990

## Low Profile Tri-Band Antenna

The new Antenna Technologies Limited Company Tri-Band surface mount antenna is an excellent choice for OEM's and system integrators requiring a Tri-Band application. The new Tri-Band antenna provides 3 dBi of gain cellular and PCS with a 27 dB gain active 5-volt GPS operation. Compact in size, measuring only 4.65 inches wide and 1.60 inch tall, the antenna is all enclosed in a weatherproof radome.

### Key Features

- ✓ Only one antenna is needed instead of two or three separate antennas
- ✓ By reducing the number of required antennas, there is a reduction in installation time and cost

**MADE IN THE USA**

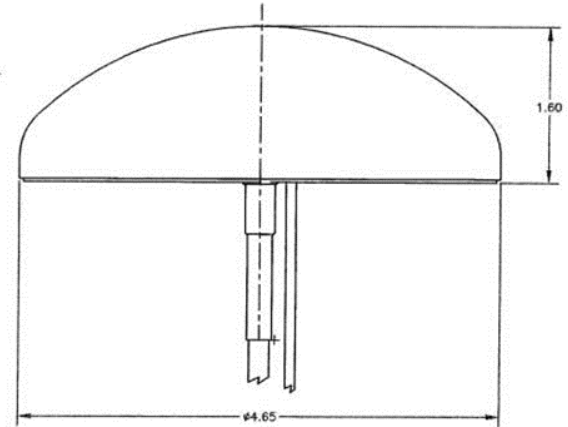

### General Specifications

Maximum Power: 50 watts	Polarization: Vertical
Termination: Pigtail*	Antenna Dimensions: 4.65" OD x 1.60" H
Operating Temperature: -30° C to + 70° C	VSWR: 2:1





\* Specify connector style. See page 41 for details.

Specifications	Low Band	High Band	GPS
Frequency, MHz	824-896	1850-1990	1575
Gain, dBi peak	3	3	25

## “LoPro” Antennas

LoPro® Antennas are ideal for public safety, covert and off-road applications. Use in public places for irrigation systems, ATMs, smart vending machines, express mail drop boxes because the LoPro® is small and less prone to vandalism.

### Key Features

-  UHF, Cellular and SMR Designs
-  NMO Mount Models Available
-  PCS, ISM Models Available
-  Available in Black or White



**MADE IN THE USA**

General Specifications		
Maximum Power: 50 watts	Polarization: Vertical	Impedance: 50 Ohms
VSWR: 1.5:1 or less	Gain: 3 dBi	

#### Adhesive Mount Models

Black	White	Frequency, MHz	Application	Operating Temperature
NP4000	NP4000W	450-470	UHF 2-Way	-40° to +180° F
NP4010	NP4010W	400-420	UHF 2-Way	-40° to +180° F
NP4020	NP4020W	410-430	UHF 2-Way	-40° to +180° F
NP8000	NP8000W	824-896	Cellular	-40° to +180° F
NP8500	NP8500W	806-866	SMR Trunking	-40° to +180° F
NP9000	NP9000W	890-960	SMR Trunking	-40° to +180° F
NP83GI	NP83GIW	806-866	SMR Trunking	-40° to +180° F
NP86GI	NP86GIW	824-896	Cellular	-40° to +180° F
NP91GI	NP91GIW	902-928	ISM	-40° to +180° F
NP92GI	NP92GIW	890-960	SMR Trunking	-40° to +180° F

GI indicates ground independent version. No ground plane required

#### NMO Mount Models

Black	White	Frequency, MHz	Application	Operating Temperature
NMO4000	NMO4000W	450-470	UHF 2-Way	-65° to +180° F
NMO4010	NMO4010W	400-420	UHF 2-Way	-65° to +180° F
NMO4020	NMO4020W	410-430	UHF 2-Way	-65° to +180° F
NMO8000	NMO8000W	824-896	Cellular	-65° to +180° F
NMO8500	NMO8500W	806-866	SMR Trunking	-65° to +180° F
NMO9900	NMO9900W	890-960	SMR Trunking	-65° to +180° F

#### Magnetic Mount Models

*Ideal antennas for homeland security applications, with easy and temporary installation, that can be added and removed easily.*

Black	White	Frequency, MHz	Application	Operating Temperature
NP8000MMSE	NP8000MMSE	824-896	Cellular	-40° to +180° F
NP8500MMSE	NP8500MMSE	806-866	SMR Trunking	-40° to +180° F
NP9000MMSE	NP9000MMSE	890-960	SMR Trunking	-40° to +180° F
NP4000MMSE	NP4000MMSE	450-470	UHF 2-Way	-40° to +180° F
NP4010MMSE	NP4010MMSE	400-420	UHF 2-Way	-40° to +180° F
NP4020MMSE	NP4020MMSE	410-430	UHF 2-Way	-40° to +180° F

## Low Profile Dual Band Public Safety Antennas

The new Dual Band Low Profile Antenna is unparalleled among markets utilizing public safety applications. By combining the proven LoPro™ technology with stacked element capabilities, ATLC continues to exceed the evolving needs and requirements of the public safety market. Previous dual band products in the 400 and 800 MHz frequencies have been large and bulky; however, the ATLC Dual Band Low Profile Antenna is sleek and modern.

### Key Features

- Compact in size, measuring only 7.5" x 1.4"
- Easy to mount
- Single cable lead for easy installation

**MADE IN THE USA**



**For additional customized frequency combinations, please contact ATLC today.**

Specifications	NP4686H
Frequency Range, MHz	450-470 and 824-896**
Element Type	Edge Slot Radiator
Gain, dBi	3
Polarization	Vertical
VSWR	1.5:1
Azimuth Beamwidth	Cosine
Elevation Beamwidth	OMNIdirectional
Impedance	50 Ohms
Maximum Power, watts	50
Termination	Pigtail, N Female
Connector*	Many Styles Available
Mounting Hardware	Adhesive Mount
Temperature	-40° to +180°F
Height x Diameter	1.4" x 7.5"



\* See page 41 for connector styles and details.



## PCD Subscriber Series Antennas

The Antenna Technologies Limited Company PCD antenna is ideal as a low profile, indoor/outdoor extended range solution for voice or data device applications. These antennas were initially developed for Wireless Local Loop (WLL) phone terminals as an alternative to the standard fix mount whip antenna. The cable length allows the user to place the antenna in a convenient location within a room for the improvement of signal quality.

### Key Features

-  Using the integral mounting legs provided, the antenna can be conveniently located several feet away from a data or phone device
-  Integral mounting legs feature screw holes in the base for permanent mounting applications
-  Velcro pads are supplied for easy removal from a window or wall.

**MADE IN THE USA**



<i>General Specifications</i>	
Element Type: Dipole	VSWR: 2:1 max
Polarization: Vertical	Impedance: 50 Ohms
Gain: 2 dBi	Power Handling: 10 watts
Azimuth Beamwidth: OMNI	Weight: <3.5 ounces
Elevation: 60°	Connector Types: Several Available*

### Frequency Selection Chart





Model Number	Frequency	Length/Diameter (inches)	** Standard Cable Length (ft.)
PCD83	806-866	8.5 / .525	12
PCD86	824-896	8.5 / .525	12
PCD91	902-928	8.5 / .525	12
PCD92	890-960	8.5 / .525	12
PCD19	1850-1990	4.75 / .525	6
PCD24	2400-2500	4.5 / .525	6

\* See page 41 for connector styles and details. \*\* Custom cable lengths are available.

## Yagi Antennas VHF Series

These state-of-the-art antennas provide ideal solutions for single and multiple frequency systems, such as rural telecommunications, repeater operations, FM and fixed site or portable point-to-point communications. Easily phased in dual or quad arrays for high gain. Stacking frames and phasing harnesses are available.

### Key Features

-  EverSealed feed system reduces environmental vulnerability.
-  Balanced AntennaFeed system provides a clean radiation pattern.
-  Mounting hardware included.
-  No Field tuning is required to obtain maximum performance

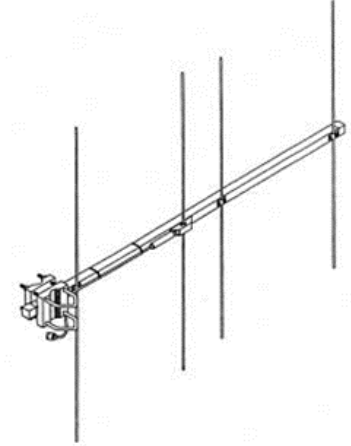

**MADE IN THE USA**

### General Specifications

Maximum Power: 150 watts*	Polarization: Vertical or Horizontal
Mast Diameter, inches (cm): 1.25-2.00 (3.2-5.1)	Mounting: Rear Except 152-8 - center mounting
Boom Material: .750" by .750" square tube 6061-T6 aluminum ** Heavy Duty: 1.0" by 1.0" square tube 6061-T6 aluminum	Element Material: .188" diameter 2011-T3 aluminum rod ** Heavy Duty: .25" diameter 6061-T6 aluminum rod
Termination: Pigtail, N Female	VSWR (50 Ohms): 1.2:1 typical

\* Limited by feedline. Higher power ratings are available as an option.





Model Number	Frequency Range (MHz)	Gain, dBd Typical	Front to Back Ratio, dB	3 dB Beamwidth E/H	# of Elements	Boom Length, feet (m)	Wind Surface Area, foot <sup>2</sup> (m <sup>2</sup> )	Wind Survival, mph (kph)	Weight, pounds (kg)
141-4	138-144	7	15	60/90°	4	3.68 (1.12)	.4 (.037)	100 (160)	2.0 (.91)
141-4H*	138-144	7	16	60/90°	4	3.68 (1.12)	.54 (.05)	125 (200)	3.75 (1.7)
151-4	147-155	7	15	60/90°	4	3.68 (1.12)	.382 (.035)	100 (160)	2.0 (.91)
151-4H*	147-155	7	15	60/90°	4	3.68 (1.12)	.54 (.05)	125 (200)	3.75 (1.7)
152-8	150-154	11	18	41/46°	8	12 (3.66)	1.1 (.10)	100 (160)	6.0 (2.72)
155-4	152-158	7	15	60/90°	4	3.68 (1.12)	.382 (.035)	100 (160)	2.0 (.91)
155-4H*	152-158	7	15	60/90°	4	3.68 (1.12)	.54 (.05)	125 (200)	3.75 (1.7)
158-4	154-162	7	15	60/90°	4	3.68 (1.12)	.382 (.035)	100 (160)	2.0 (.91)
158-4H*	154-162	7	15	60/90°	4	3.68 (1.12)	.54 (.05)	125 (200)	3.75 (1.7)
162-5H*	159-165	8	22	54/71°	5	5 (1.52)	.79 (0.73)	100 (160)	3.8 (1.73)
165-4	161-169	7	15	61/89°	4	3.68 (1.12)	.382 (.035)	100 (160)	2.0 (.91)
165-4H*	161-169	7	15	61/89°	4	3.68 (1.12)	.54 (.05)	125 (200)	3.75 (1.7)
172-4	168-176	7	15	61/89°	4	3.68 (1.12)	.369 (.34)	100 (160)	2.0 (.91)
172-4H*	168-176	7	15	61/89°	4	3.68 (1.12)	.54 (.05)	125 (200)	4.3 (1.9)

Custom construction. Heavy duty yagis are ruggedly designed to withstand ice, moisture and harsh environments. frequencies available. Contact ATLC for details.

## Yagi Antennas 200 MHz Series

The wide bandwidth design enables these antennas to meet the requirements of dedicated links for telemetry and radio telephone installations. The quick and easy assembly also allows these antennas to be used for portable applications.

### Key Features

-  *EverSealed* feed system reduces environmental vulnerability.
-  Balanced *AntennaFeed* system provides a clean radiation pattern.
-  Mounting hardware included.
-  *No Field tuning* is required to obtain maximum performance

**MADE IN THE USA**

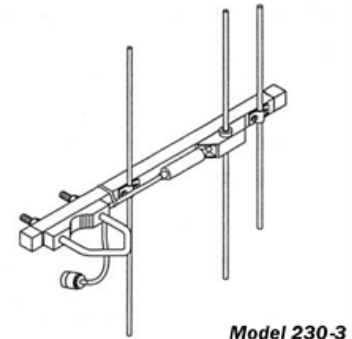

Model 230-3

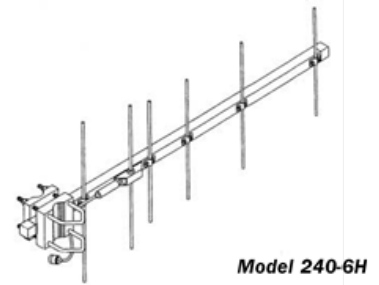

Model 240-6H

General Specifications	
Maximum Power: 50 watts*	Polarization: Vertical or Horizontal
Mast Diameter, inches (cm): 1.25-2.00 (3.2-5.1)	Mounting: Rear
Boom Material: .750" by .750" square tube 6061-T6 aluminum ** <i>Heavy Duty</i> : 1.0" by 1.0" square tube 6061-T6 aluminum	Element Material: .188" diameter 2011-T3 aluminum rod ** <i>Heavy Duty</i> : .25" diameter 6061-T6 aluminum rod
Termination: Pigtail, N Female	VSWR (50 Ohms): 1.2:1 typical

\* Limited by feedline. Higher power ratings are available as an option.

Model Number	Frequency Range (MHz)	Gain, dBd Typical	Front to Back Ratio, dB	3 dB Beamwidth E/H	# of Elements	Boom Length, feet (m)	Wind Surface Area, foot <sup>2</sup> (m <sup>2</sup> )	Wind Survival, mph (kph)	Weight, pounds (kg)
220-4	215-225	7	16	61/90	4	2.75 (.84)	.27 (.025)	125 (200)	2.0 (.91)
220-4H*	215-225	7	16	61/90	4	2.75 (.84)	.4 (.037)	150 (240)	3.0 (1.4)
220-6	215-225	9	15	51/63	6	5.0 (1.5)	.47 (.044)	100 (160)	2.5 (1.13)
220-6H*	215-225	9	15	50/62	6	5.0 (1.5)	.67 (.06)	125 (200)	4.25 (1.9)
230-3	220-230	5	16	66/116	3	1.1 (.66)	.23 (.021)	125 (200)	2.0 (.91)
230-3H*	220-230	5	16	66/116	3	1.1 (.66)	.23 (.021)	150 (240)	3.0 (1.4)
230-4	225-237	7	16	61/90	4	2.75 (.84)	.27 (.025)	100 (160)	2.0 (.91)
230-4H*	225-237	7	16	61/90	4	2.75 (.84)	.4 (.037)	150 (240)	3.0 (1.4)
230-6	225-237	9	16	53/67	6	5.0 (1.5)	.46 (.043)	100 (160)	2.5 (1.13)
230-6H*	225-237	9	16	50/61	6	5.0 (1.5)	.67 (.06)	125 (200)	4.0 (1.8)
240-4	237-250	7	16	62/91	4	2.6 (.79)	.27 (.025)	100 (160)	2.0 (.91)
240-4H*	237-250	7	16	62/91	4	2.6 (.79)	.4 (.037)	125 (200)	3.0 (1.4)
240-6	237-250	9	15	51/63	6	5.0 (1.5)	.45 (.042)	100 (160)	2.5 (1.13)
240-6H*	237-250	9	16	50/61	6	5.0 (1.5)	.67 (.06)	125 (200)	4.0 (1.8)





\* H denotes Heavy Duty construction. Heavy duty yagis are ruggedly designed to withstand ice, moisture and harsh environments.

~ Custom frequencies available. Contact ATLC for details.

## Yagi Antennas 300 MHz Series

These state-of-the-art antennas are ideal for applications where economy and performance are required. An excellent choice for low cost RF security monitoring and other localized UHF installations. These antennas feature a computer optimized design that combines maximum performance with survivability.

### Key Features

-  EverSealed feed system reduces environmental vulnerability.
-  Balanced AntennaFeed system provides a clean radiation pattern.
-  Mounting hardware included.
-  Square tube construction with solid rod elements for outstanding durability.
-  No Field tuning is required to obtain maximum performance

**MADE IN THE USA**

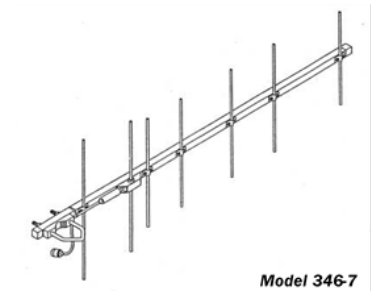
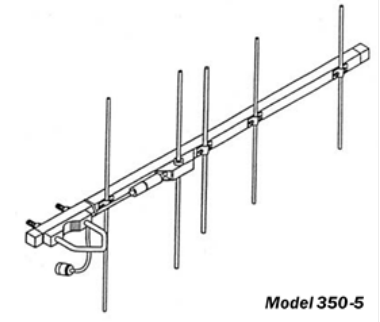

### General Specifications

Maximum Power: 50 watts*	Polarization: Vertical or Horizontal
Mast Diameter, inches (cm): 1.25-2.00 (3.2-5.1)	Mounting: Rear
Boom Material: .750" by .750" square tube 6061-T6 aluminum ** Heavy Duty: 1.0" by 1.0" square tube 6061-T6 aluminum	Element Material: .188" diameter 2011-T3 aluminum rod ** Heavy Duty: .25" diameter 6061-T6 aluminum rod
Termination: Pigtail, N Female	VSWR (50 Ohms): 1.2:1 typical

\* Limited by feedline. Higher power ratings are available as an option.

Model Number	Frequency Range (MHz)	Gain, dBd Typical	Front to Back Ratio, dB	3 dB Beamwidth E/H	# of Elements	Boom Length, feet (m)	Wind Surface Area, foot <sup>2</sup> (m <sup>2</sup> )	Wind Survival, mph (kph)	Weight, pounds (kg)
346-7	338-354	9	18	48/57	7	4.2	.39	100 (160)	2.25 (1.02)
346-7H*	338-354	9	18	48/57	7	4.2	.062	125 (200)	4.3 (1.95)
350-5	345-355	8	16	55/72	5	2.5	.24	100 (160)	2.0 (.91)
350-5H*	345-355	8	16	55/72	5	2.5	.24	125 (200)	4.3 (1.95)
364-5	350-378	8	20	55/72	5	2.75	.28	100 (160)	2.5 (1.13)
364-5H*	350-378	8	20	55/72	5	2.75	.24	125 (200)	4.3 (1.95)





\* H denotes Heavy Duty construction. Heavy duty yagis are ruggedly designed to withstand ice, moisture and harsh environments.

~ Custom frequencies available. Contact ATLC for details.

## Yagi Antennas UHF Series

These antennas provide a low-cost solution for point-to-point service, rural telephone, portable comlinks and long-range repeater access. The square tube boom construction with solid rod elements enable outstanding durability.

### Key Features

-  EverSealed feed system reduces environmental vulnerability.
-  Balanced AntennaFeed system provides a clean radiation pattern.
-  Mounting hardware included.
-  No Field tuning is required to obtain maximum performance

**MADE IN THE USA**

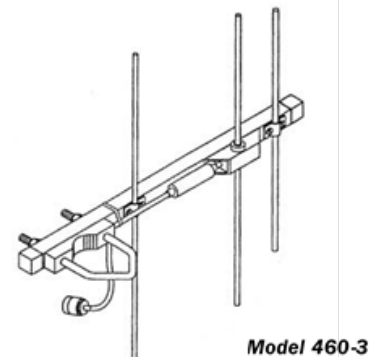

Model 460-3

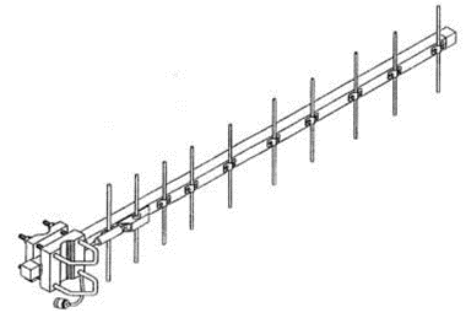

General Specifications	
Maximum Power: 100 watts*	Polarization: Vertical or Horizontal
Mast Diameter, inches (cm): 1.25-2.00 (3.2-5.1)	Mounting: Rear
Boom Material: .750" by .750" square tube 6061-T6 aluminum ** Heavy Duty: 1.0" by 1.0" square tube 6061-T6 aluminum	Element Material: .188" diameter 2011-T3 aluminum rod** Heavy Duty: .25" diameter 6061-T6 aluminum rod
Termination: Pigtail, N Female	VSWR (50 Ohms): 1.2:1 typical

\* Limited by feedline. Higher power ratings are available as an option.

Model Number	Frequency Range (MHz)	Gain, dBd Typical	Front to Back Ratio, dB	3 dB Beamwidth E/H	# of Elements	Boom Length, feet (m)	Wind Surface Area, foot <sup>2</sup> (m <sup>2</sup> )	Wind Survival, mph (kph)	Weight, pounds (kg)
410-6H*	406-420	9	17	53/68°	6	2.75 (.84)	.42 (.039)	150 (240)	3.5 (1.6)
420-10	406-430	11	18	41/46°	1	5.5 (1.68)	.457 (.04)	100 (160)	2.5 (1.13)
420-10H*	406-430	11	20	41/46°	1	5.5 (1.68)	.7 (.065)	125 (200)	4.5 (2.1)
460-2	450-470	3	10	71/147°	2	1.1 (.33)	.1 (.01)	125 (200)	1.5 (.68)
460-3	450-470	5	20	67/116°	3	1.25 (.38)	.125 (.012)	150 (240)	1.5 (.68)
460-6	450-470	9	17	50/62°	6	2.75 (.84)	.236 (.022)	125 (200)	2.0 (.91)
460-6H*	450-470	9	17	50/62°	6	2.75 (.84)	.42 (.039)	150 (240)	3.5 (1.6)
460-7	450-470	10	18	46/54°	7	4 (1.22)	.3 (.03)	100 (160)	2.5 (1.13)
460-7H*	450-470	10	18	46/54°	7	4 (1.22)	.48 (.044)	125 (200)	3.8 (1.7)
460-10	450-470	11	20	40/45°	1	5.5 (1.68)	.7 (.065)	100 (160)	4.5 (2.1)
460-10H*	450-470	11	20	40/45°	1	5.5 (1.68)	.7 (.065)	125 (200)	4.5 (2.1)
480-6	470-490	9	17	49/60°	6	2.75 (.84)	.236 (.022)	125 (200)	2.0 (.91)
480-6H*	470-490	9	17	49/60°	6	2.75 (.84)	.236 (.022)	125 (200)	2.0 (.91)
480-10	470-490	11	20	40/44°	1	5.4 (1.64)	.457 (.04)	100 (160)	4.5 (2.1)
480-10H*	470-490	11	20	40/44°	1	5.4 (1.64)	.457 (.04)	125 (200)	4.5 (2.1)
500-10	490-512	11	20	39/44°	1	5.4 (1.64)	.46 (.04)	100 (160)	4.5 (2.1)
500-10H*	490-512	11	20	39/44°	1	5.4 (1.64)	.46 (.04)	125 (200)	4.5 (2.1)





\* H denotes Heavy Duty construction. Heavy duty yagis are ruggedly designed to withstand ice, moisture and harsh environments.

~ Custom frequencies available. Contact ATLC for details.

## Yagi Antennas 700 MHz Series

These state-of-the-art antennas are ideal for spread spectrum, trunking and security applications. The square tube boom construction with solid rod elements enable outstanding durability.

### Key Features

-  EverSealed feed system reduces environmental vulnerability.
-  Balanced AntennaFeed system provides a clean radiation pattern.
-  Mounting hardware included.
-  No Field tuning is required to obtain maximum performance

**MADE IN THE USA**

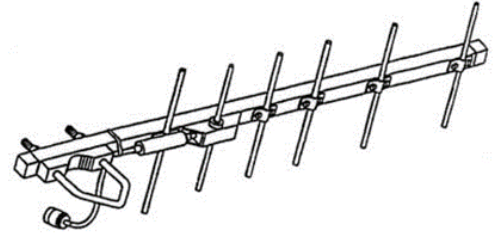

**Model 770-6**

General Specifications		
Maximum Power: 50 watts*	Polarization: Vertical or Horizontal	Mounting: Rear
Mast Diameter, inches (cm): 1.25-2.00 (3.2-5.1)	Termination: Pigtail, N Female	VSWR (50 Ohms): 1.2:1 typical
Boom Material: .750" by .750" square tube 6061-T6 aluminum	Element Material: .188" diameter 2011-T3 aluminum rod	* Limited by feedline. Higher power ratings are available as an option.

Model Number	Frequency Range (MHz)	Gain, dBd Typical	Front to Back Ratio, dB	3 dB Beamwidth E/H	# of Elements	Boom Length, feet (m)	Wind Surface Area, foot <sup>2</sup> (m <sup>2</sup> )	Wind Survival, mph (kph)	Weight, pounds (kg)
770-2	740-800	4	10	71/14	2	1.0	.1	150	1.0
770-3	740-800	5	16	68/11	3	1.1	.11	150	1.0
770-4	740-800	7	14	57/78	4	1.25	.12	150	1.0
770-6	740-800	9	16	49/59	6	2.0	.159	125	1.2
770-6H*	740-800	9	16	47/55	6	2.0	.313	150	3.1
770-10	740-800	12	16	34/36	10	3.42	.287	100	2.75
770-10H*	740-800	12	16	34/36	10	3.42	.46	150	4.5
770-15	740-800	13	16	30/32	15	5.0	.458	100	3.0
770-15H*	740-800	13	16	30/32	15	5.0	.59	125	4.0

\* H denotes Heavy Duty construction. Heavy duty yagis are ruggedly designed to withstand ice, moisture and harsh environments.

~ Custom frequencies available. Contact ATLC for details.

## Enviro-Sealed Protect Yagi Antennas 700 MHz Series

### Key Features

- ✓ Totally encapsulated feed system to ensure no moisture penetration.
- ✓ Coated with Aliphatic Acrylic Urethane coating to virtually eliminate corrosion or discoloration due to ultraviolet rays and salt air environments.
- ✓ Designed to withstand operating temperatures of -40° to +160° Fahrenheit.
- ✓ All mounting hardware included.

**MADE IN THE USA**

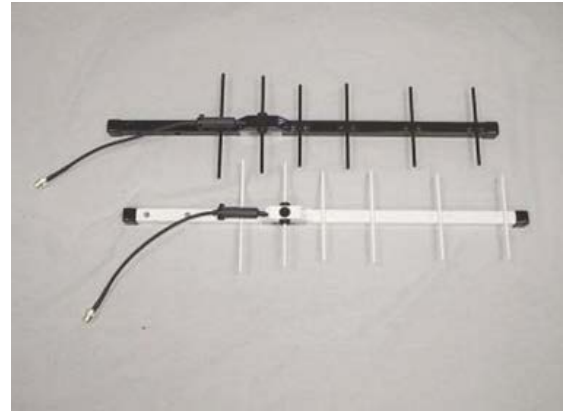

**Model 770-6 ESP**

General Specifications	
Maximum Power: 50 watts*	Polarization: Vertical or Horizontal
Mast Diameter, inches (cm): 1.25-2.00 (3.2-5.1)	Mounting: Rear
Boom Material: .750" by .750" square tube 6061-T6 aluminum ** Heavy Duty: 1.0" by 1.0" square tube 6061-T6 aluminum	Element Material: .188" diameter 2011-T3 aluminum rod ** Heavy Duty: .25" diameter 6061-T6 aluminum rod
Termination: Pigtail, N Female	VSWR (50 Ohms): 1.2:1 typical

\* Limited by feedline. Higher power ratings are available as an option.

Model Number	Frequency Range (MHz)	Gain, dBd Typical	Front to Back Ratio, dB	3 dB Beamwidth E/H	# of Elements	Boom Length, feet (m)	Wind Surface Area, foot <sup>2</sup> (m <sup>2</sup> )	Wind Survival, mph (kph)	Weight, pounds (kg)
770-2 ESP	740-800	4	10	71/140	2	1.0	.11 (.01)	150 (240)	1.0 (.45)
770-3 ESP	740-800	5	16	68/118	3	.11	.11 (.01)	150 (240)	1.0 (.45)
770-4 ESP	740-800	7	14	57/78°	4	.12	.12 (.011)	150 (240)	1.0 (.45)
770-6 ESP	740-800	9	16	49/59°	6	2.0	.159 (.015)	125 (200)	1.2 (.54)
770-6H* ESP	740-800	9	16	49/59°	6	2.0	.313 (.029)	150 (240)	3.1 (1.36)
770-10 ESP	740-800	12	16	34/36°	10	3.42 (1.04)	.287 (.027)	100 (160)	2.75 (1.25)
770-10H* ESP	740-800	12	16	34/36°	10	3.42 (1.04)	.46 (.043)	150 (240)	4.5 (2.1)
770-15 ESP	740-800	13	16	30/32°	15	5.0	.458 (.043)	100 (160)	3.0 (1.36)
770-15H* ESP	740-800	13	16	30/32°	15	5.0	.59 (.055)	125 (200)	4.0 (1.8)

\* H denotes Heavy Duty construction. Heavy duty yagis are ruggedly designed to withstand ice, moisture and harsh environments.

~ Custom frequencies available. Contact ATLC for details.





For Black, add B to end of the model number. Example: 770-2 ESPB.

For White, add W to end of the model number. For example, 770-2 ESPW

## Yagi Antennas 800 MHz Series

These state-of-the-art antennas are ideal for 800 MHz trunking communications as well as broadband cellular service.

### Key Features

-  EverSealed feed system reduces environmental vulnerability.
-  Balanced AntennaFeed system provides a clean radiation pattern.
-  Mounting hardware included.
-  No Field tuning is required to obtain maximum performance

**MADE IN THE USA**

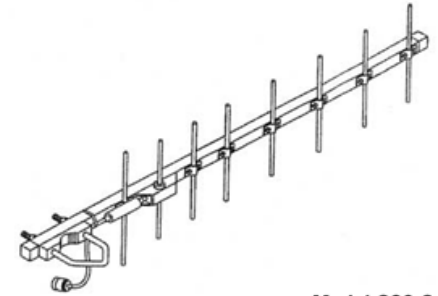

Model 860-8

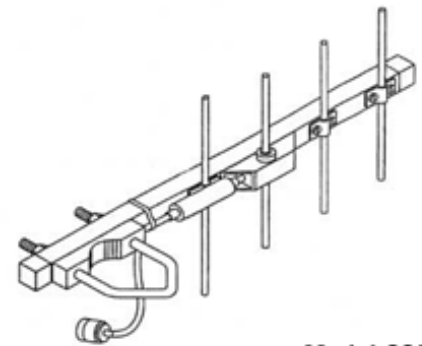

Model 835-4

### General Specifications

Maximum Power: 50 watts*	Polarization: Vertical or Horizontal
Mast Diameter, inches (cm): 1.25-2.00 (3.2-5.1)	Mounting: Rear
Boom Material: .750" by .750" square tube 6061-T6 aluminum ** Heavy Duty: 1.0" by 1.0" square tube 6061-T6 aluminum	Element Material: .188" diameter 2011-T3 aluminum rod ** Heavy Duty: .25" diameter 6061-T6 aluminum rod
Termination: Pigtail, N Female	VSWR (50 Ohms): 1.2:1 typical

\* Limited by feedline. Higher power ratings are available as an option.

Model Number	Frequency Range (MHz)	Gain, dBd Typical	Front to Back Ratio, dB	3 dB Beamwidth E/H	# of Elements	Boom Length, feet (m)	Wind Surface Area, foot <sup>2</sup> (m <sup>2</sup> )	Wind Survival, mph (kph)	Weight, pounds (kg)
835-4	806-866	7	12	59/81°	4	1.25 (.38)	.159 (.015)	150 (240)	1.0(.45)
835-6	806-866	9	16	49/59°	6	2.0(.58)	.18 (.017)	125 (200)	1.2(.54)
835-6H*	806-866	9	16	49/59°	6	2.0(.58)	.234 (.022)	150 (240)	3.1(1.4)
835-8	806-866	10	16	43/50°	8	2.67 (.81)	.25 (.023)	125 (200)	1.75(.8)
835-8H*	806-866	10	16	43/50°	8	2.67 (.81)	.234 (.022)	150 (240)	2.75(1.3)
835-10	806-866	12	16	38/42°	10	3.68 (1.12)	.3	100 (160)	2.0(.91)
835-10H*	806-866	12	16	38/42°	10	3.68 (1.12)	.41 (.038)	125 (200)	4.0(1.8)
860-4	824-896	7	12	60/84°	4	1.25 (.38)	.125 (.012)	150 (240)	1.25(.57)
860-6	824-896	9	15	52/64°	6	2.0(.58)	.19 (.017)	125 (200)	1.5(.68)
860-6H*	824-896	9	15	52/64°	6	2.0(.58)	.234 (.022)	150 (240)	3.1(1.4)
860-8	824-896	10	16	43/50°	8	2.67 (.81)	.25 (.023)	125 (200)	1.75(.8)
860-8H*	824-896	10	16	43/50°	8	2.67 (.81)	.234 (.022)	150 (240)	2.75(1.3)
860-10	824-896	12	16	37/41°	10	3.58 (1.1)	.3	100 (160)	1.9(1.86)
860-10H*	824-896	12	16	37/41°	10	3.58 (1.1)	.41 (.038)	125 (200)	4.0(1.8)
890-4	806-960	5	12	64/99°	4	1.3(.45)	.13 (.012)	150 (240)	1.0(.45)





\* H denotes Heavy Duty construction. Heavy duty yagis are ruggedly designed to withstand ice, moisture and harsh environments.

~ Custom frequencies available. Contact ATLC for details.



## Enviro-Sealed Protect Yagi Antennas 800 MHz Series

### Key Features

-  Totally encapsulated feed system to ensure no moisture penetration.
-  Coated with Aliphatic Acrylic Urethane coating to virtually eliminate corrosion or discoloration due to ultraviolet rays and salt air environments.
-  Designed to withstand operating temperatures of -40° to +160° Fahrenheit.
-  All mounting hardware included.

**MADE IN THE USA**

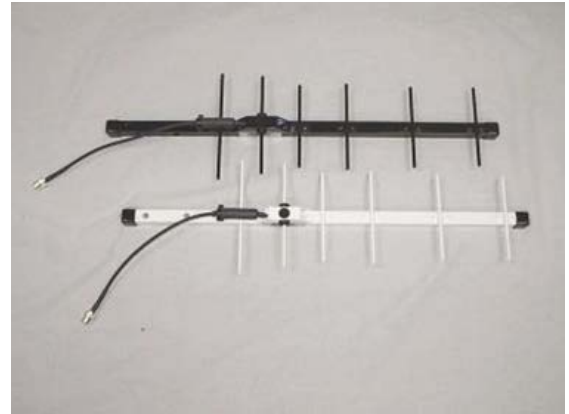

**Model 860-6 ESP**

General Specifications	
Maximum Power: 50 watts*	Polarization: Vertical or Horizontal
Mast Diameter, inches (cm): 1.25-2.00 (3.2-5.1)	Mounting: Rear
Boom Material: .750" by .750" square tube 6061-T6 aluminum <b>** Heavy Duty: 1.0" by 1.0" square tube 6061-T6 aluminum</b>	Element Material: .188" diameter 2011-T3 aluminum rod <b>** Heavy Duty: .25" diameter 6061-T6 aluminum rod</b>
Termination: Pigtail, N Female	VSWR (50 Ohms): 1.2:1 typical

\* Limited by feedline. Higher power ratings are available as an option.

Model Number	Frequency Range (MHz)	Gain, dBd Typical	Front to Back Ratio, dB	3 dB Beamwidth E/H	# of Elements	Boom Length, feet (m)	Wind Surface Area, foot <sup>2</sup> (m <sup>2</sup> )	Wind Survival, mph (kph)	Weight, pounds (kg)
835-6 ESP	806-866	9	16	49/59	6	2.0	.18 (.017)	125 (200)	1.2(.54)
835-6H* ESP	806-866	9	16	49/59	6	2.0	.234 (.022)	150 (240)	3.1(1.4)
835-8 ESP	806-866	10	16	43/50	8	2.67	.25 (.023)	125 (200)	1.75(.8)
835-8H* ESP	806-866	10	16	43/50	8	2.67	.234 (.022)	150 (240)	2.75(1.3)
835-10 ESP	806-866	12	16	38/42	10	3.68	.3 (.03)	100 (160)	2.0(.91)
835-10H* ESP	806-866	12	16	38/42	10	3.68	.41 (.038)	125 (200)	4.0(1.8)
860-4 ESP	824-896	7	12	60/84	4	1.25	.125 (.012)	150 (240)	1.25(.57)
860-6 ESP	824-896	9	15	52/64	6	2.0	.19 (.017)	125 (200)	1.5(.68)
860-6H* ESP	824-896	9	15	52/64	6	2.0	.234 (.022)	150 (240)	3.1(1.4)
860-8 ESP	824-896	10	16	43/50	8	2.67	.25 (.023)	125 (200)	1.75(.8)
860-8H* ESP	824-896	10	16	43/50	8	2.67	.234 (.022)	150 (240)	2.75(1.3)
860-10 ESP	824-896	12	16	37/41	10	3.58	.3 (.03)	100 (160)	1.9(.86)
860-10H* ESP	824-896	12	16	37/41	10	3.58	.41 (.038)	125 (200)	4.0(1.8)
890-4ESP	806-960	5	12	64/99	4	1.3	.13 (.012)	150 (240)	1.0(.45)

\* H denotes Heavy Duty construction. Heavy duty yagis are ruggedly designed to withstand ice, moisture and harsh environments.

~ Custom frequencies available. Contact ATCLC for details.





For Black, add B to end of the model number. Example: 835-4 ESPB.

For White, add W to end of the model number. For example, 835-4 ESPW

## Yagi Antennas 900 MHz Series

These antennas provide excellent electrical performance matched with a rugged mechanical design to deliver a high value solution for antenna requirements. An excellent choice for LAN, data, trunking, telemetry, and security monitoring applications.

### Key Features

-  EverSealed feed system reduces environmental vulnerability.
-  Balanced AntennaFeed system provides a clean radiation pattern.
-  Mounting hardware included.
-  No Field tuning is required to obtain maximum performance

**MADE IN THE USA**

General Specifications	
Maximum Power: 50 watts*	Polarization: Vertical or Horizontal
Mast Diameter, inches (cm): 1.25-2.00 (3.2-5.1)	Mounting: Rear
Boom Material: .750" by .750" square tube 6061-T6 aluminum ** Heavy Duty: 1.0" by 1.0" square tube 6061-T6 aluminum	Element Material: .188" diameter 2011-T3 aluminum rod ** Heavy Duty: .25" diameter 6061-T6 aluminum rod
Termination: Pigtail, N Female	VSWR (50 Ohms): 1.2:1 typical

\* Limited by feedline. Higher power ratings are available as an option.

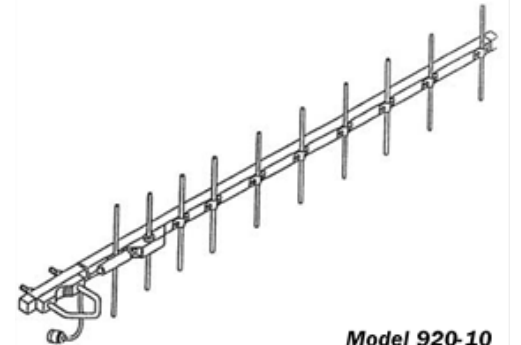

Model 920-10

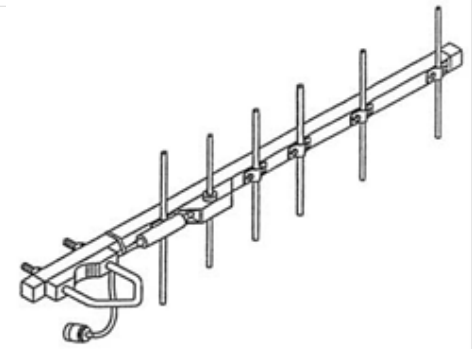

Model 928-6

Model Number	Frequency Range (MHz)	Gain, dBd Typical	Front to Back Ratio, dB	3 dB Beamwidth E/H	# of Elements	Boom Length, feet (m)	Wind Surface Area, foot <sup>2</sup> (m <sup>2</sup> )	Wind Survival, mph (kph)	Weight, pounds (kg)
920-10	896-940	12	16	38/42	10	3.6 (1.18)	.287	100 (180)	2.75 (1.25)
920-10H*	896-940	12	16	38/42°	10	3.6 (1.18)	.43(.04)	125 (200)	3.75(1.7)
928-3	896-960	5	16	68/119	3	1.1	.11(.01)	150 (240)	1.0(.45)
928-4	896-960	7	14	58/81°	4	1.25 (.38)	.12 (.011)	150 (240)	1.0(.45)
928-6	896-960	9	16	49/59°	6	2.0	.17 (.016)	125 (200)	1.2(.54)
928-6H*	896-960	9	16	49/59°	6	2.0	.313 (.029)	150 (240)	3.1(1.36)
928-10	896-960	12	16	38/42°	10	3.42 (1.04)	.287 (.027)	100 (160)	2.75 (1.25)
944-10	928-960	12	16	37/41°	10	3.6 (1.18)	.287 (.027)	100 (160)	2.75 (1.25)
944-10H*	928-960	12	16	37/41°	10	3.6 (1.18)	.46(.04)	125 (200)	3.75(1.7)
944-15	928-960	13	16	31/33°	15	5.0 (1.52)	.418 (.039)	100 (160)	3.0(.136)
944-15H*	928-960	13	18	31/33°	15	5.0 (1.52)	.59 (.055)	125 (200)	4.0(1.8)

\* H denotes Heavy Duty construction. Heavy duty yagis are ruggedly designed to withstand ice, moisture and harsh environments.

~ Custom frequencies available. Contact ATLC for details.

## Enviro-Sealed Protect Yagi Antennas 900 MHz

### Key Features

- ✓ Totally encapsulated feed system to ensure no moisture penetration.
- ✓ Coated with Aliphatic Acrylic Urethane coating to virtually eliminate corrosion or discoloration due to ultraviolet rays and salt air environments.
- ✓ Designed to withstand operating temperatures of -40° to +160° Fahrenheit.
- ✓ All mounting hardware included.

**MADE IN THE USA**

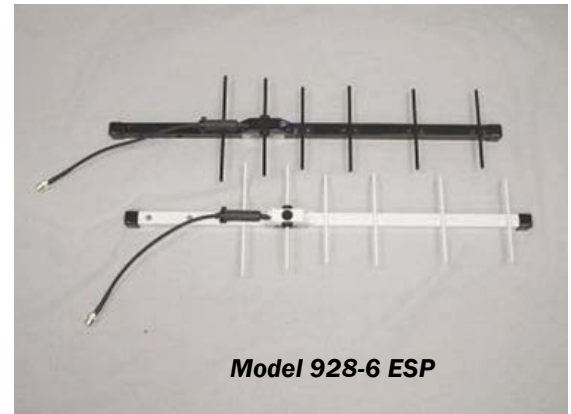

**Model 928-6 ESP**

### General Specifications

Maximum Power: 50 watts*	Polarization: Vertical or Horizontal
Mast Diameter, inches (cm): 1.25-2.00 (3.2-5.1)	Mounting: Rear
Boom Material: .750" by .750" square tube 6061-T6 aluminum ** Heavy Duty: 1.0" by 1.0" square tube 6061-T6 aluminum	Element Material: .188" diameter 2011-T3 aluminum rod ** Heavy Duty: .25" diameter 6061-T6 aluminum rod
Termination: Pigtail, N Female	VSWR (50 Ohms): 1.2:1 typical

\* Limited by feedline. Higher power ratings are available as an option.

Model Number	Frequency Range (MHz)	Gain, dBd Typical	Front to Back Ratio, dB	3 dB Beamwidth E/H	# of Elements	Boom Length, feet (m)	Wind Surface Area, foot <sup>2</sup> (m <sup>2</sup> )	Wind Survival, mph (kph)	Weight, pounds (kg)
920-10 ESP	896-940	12	16	38/42°	1	3.6 (1.18)	.287 (.029)	100 (160)	2.75 (1.25)
920-10H* ESP	896-940	12	16	38/42°	1	3.6 (1.18)	.43 (.04)	125 (200)	3.75 (1.7)
928-3 ESP	896-960	5	16	68/119	3	1.1 (.33)	.11 (.01)	150 (240)	1.0 (.45)
928-4 ESP	896-960	7	14	58/81°	4	1.25 (.38)	.12 (.011)	150 (240)	1.0 (.45)
928-6 ESP	896-960	9	16	49/59°	6	2.0 (.58)	.17 (.016)	125 (200)	1.2 (.54)
928-6H* ESP	896-960	9	16	49/59°	6	2.0 (.58)	.313 (.029)	150 (240)	3.1 (1.36)
928-10	896-960	12	16	38/42°	1	3.42 (1.04)	.287 (.027)	100 (160)	2.75 (1.25)
944-10 ESP	928-960	12	16	37/41°	1	3.6 (1.18)	.287 (.027)	100 (160)	2.75 (1.25)
944-10H* ESP	928-960	12	16	37/41°	1	3.6 (1.18)	.46 (.04)	125 (200)	3.75 (1.7)
944-15 ESP	928-960	13	16	31/33°	1	5.0 (1.52)	.418 (.039)	125 (200)	3.0 (.136)
944-15H* ESP	928-960	13	18	31/33°	1	5.0 (1.52)	.59 (.055)	125 (200)	4.0 (1.8)

\* H denotes Heavy Duty construction. Heavy duty yagis are ruggedly designed to withstand ice, moisture and harsh environments.

~ Custom frequencies available. Contact ATLC for details.

For Black, add B to end of the model number. Example: 920-10 ESPB.





For White, add W to end of the model number. For example, 920-10 ESPW

## Yagi Antennas 902 MHz Series

These antennas provide excellent electrical performance matched with a rugged mechanical design to deliver a high value antenna solution.

A durable, economic spread spectrum antenna solution for FCC Part 15 and 902-928 MHz applications.

### Key Features

-  EverSealed feed system reduces environmental vulnerability.
-  Balanced AntennaFeed system provides a clean radiation pattern.
-  Square boom construction with solid rod elements for outstanding durability
-  Mounting hardware included.
-  No Field tuning is required to obtain maximum performance

**MADE IN THE USA**

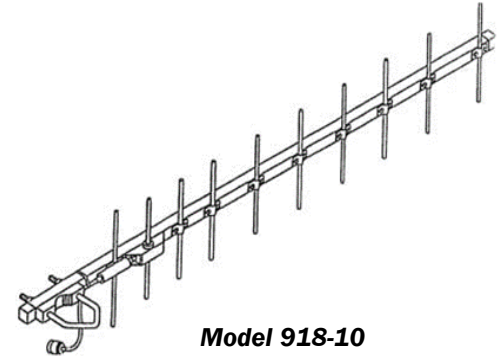

**Model 918-10**

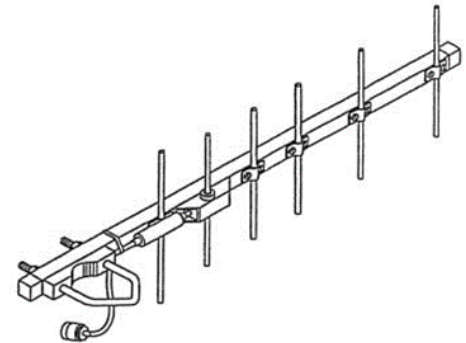

**Model 918-6**

General Specifications	
Maximum Power: 50 watts*	Polarization: Vertical or Horizontal
Mast Diameter, inches (cm): 1.25-2.00 (3.2-5.1)	Mounting: Rear
Boom Material: .750" by .750" square tube 6061-T6 aluminum ** Heavy Duty: 1.0" by 1.0" square tube 6061-T6 aluminum	Element Material: .188" diameter 2011-T3 aluminum rod ** Heavy Duty: .25" diameter 6061-T6 aluminum rod
Termination: Pigtail, N Female	VSWR (50 Ohms): 1.2:1 typical

\* Limited by feedline. Higher power ratings are available as an option.





Model Number	Frequency Range (MHz)	Gain, dBd Typical	Front to Back Ratio, dB	3 dB Beamwidth E/H	# of Elements	Boom Length, feet (m)	Wind Surface Area, foot <sup>2</sup> (m <sup>2</sup> )	Wind Survival, mph (kph)	Weight, pounds (kg)
918-2	902-928	4	10	71/140	2	1.0 (.35)	.1 (.01)	150 (240)	1.0 (.45)
918-3	902-928	5	16	68/118	3	1.1 (.33)	.11 (.01)	150 (240)	1.0 (.45)
918-4	902-928	7	14	57/78°	4	1.25 (.38)	.12 (.011)	150 (240)	1.0 (.45)
918-4H*	902-928	7	15	58/80°	4	1.25 (.38)	.20 (.019)	150 (240)	2.75 (1.25)
918-6	902-928	9	16	49/59°	6	2.0 (.58)	.159 (.015)	125 (200)	1.2 (.54)
918-6H*	902-928	9	16	47/55°	6	2.0 (.58)	.313 (.029)	150 (240)	3.1 (1.36)
918-7	902-928	10	18	45/52°	7	2.33 (.71)	.2 (.019)	125 (200)	1.5 (.68)
918-8	902-928	10	18	43/48°	8	2.67 (.81)	.25 (.23)	125 (200)	1.75 (.8)
918-10	902-928	12	16	34/36°	10	3.42 (1.04)	.287 (.027)	100 (160)	2.75 (1.25)
918-	902-928	12	16	34/36°	10	3.42 (1.04)	.46 (.043)	150 (240)	4.5 (2.1)
918-15	902-928	13	16	30/32°	15	5.0 (1.52)	.458 (.043)	100 (160)	3.0 (1.36)
918-	902-928	13	16	30/32°	15	5.0 (1.52)	.59 (.055)	125 (200)	4.0 (1.8)

\* H denotes Heavy Duty construction. Heavy duty yagis are ruggedly designed to withstand ice, moisture and harsh environments.

~ Custom frequencies available. Contact ATLC for details.

## Enviro-Sealed Protect Yagi Antenna 902 MHz Series

### Key Features

-  Totally encapsulated feed system to ensure no moisture penetration.
-  Coated with Aliphatic Acrylic Urethane coating to virtually eliminate corrosion or discoloration due to ultraviolet rays and salt air environments.
-  Designed to withstand operating temperatures of -40° to +160° Fahrenheit.
-  All mounting hardware included.

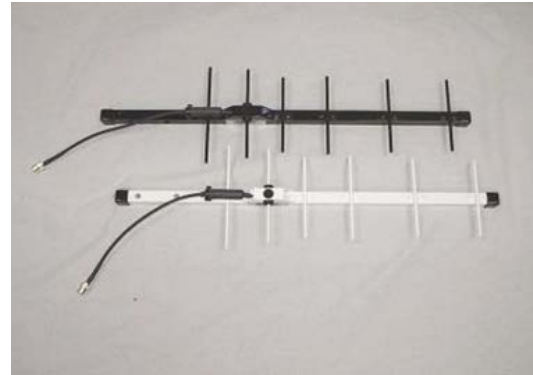

**Model 918-6 ESP**

**MADE IN THE USA**

### General Specifications

Maximum Power: 50 watts*	Polarization: Vertical or Horizontal
Mast Diameter, inches (cm): 1.25-2.00 (3.2-5.1)	Mounting: Rear
Boom Material: .750" by .750" square tube 6061-T6 aluminum <b>** Heavy Duty: 1.0" by 1.0" square tube 6061-T6 aluminum</b>	Element Material: .188" diameter 2011-T3 aluminum rod <b>** Heavy Duty: .25" diameter 6061-T6 aluminum rod</b>
Termination: Pigtail, N Female	VSWR (50 Ohms): 1.2:1 typical

\* Limited by feedline. Higher power ratings are available as an option.

Model Number	Frequency Range (MHz)	Gain, dBd Typical	Front to Back Ratio, dB	3 dB Beamwidth E/H	# of Elements	Boom Length, feet (m)	Wind Surface Area, foot <sup>2</sup> (m <sup>2</sup> )	Wind Survival, mph (kph)	Weight, pounds (kg)
918-2 ESP	902-928	4	10	71/140°	2	1.0 (.30)	.1 (.01)	150 (240)	1.0 (.45)
918-3 ESP	902-928	5	16	68/118°	3	1.1 (.33)	.11 (.01)	150 (240)	1.0 (.45)
918-4 ESP	902-928	7	14	57/78°	4	1.25 (.38)	.12 (.011)	150 (240)	1.0 (.45)
918-4H*	902-928	7	15	58/80°	4	1.25 (.38)	.20 (.019)	150 (240)	2.75 (1.25)
918-6 ESP	902-928	9	16	49/59°	6	2.0 (.58)	.159 (.015)	125 (200)	1.2 (.54)
918-6H*	902-928	9	16	47/55°	6	2.0 (.58)	.313 (.029)	150 (240)	3.1 (1.36)
918-7 ESP	902-928	10	18	45/52°	7	2.33 (.71)	.2 (.019)	125 (200)	1.5 (.68)
918-8 ESP	902-928	10	18	43/48°	8	2.67 (.81)	.25 (.23)	125 (200)	1.75 (.8)
918-10	902-928	12	16	34/36°	10	3.42 (1.04)	.287 (.027)	100 (160)	2.75 (1.25)
918-10H*	902-928	12	16	34/36°	10	3.42 (1.04)	.46 (.043)	150 (240)	4.5 (2.1)
918-15	902-928	13	16	30/32°	15	5.0 (1.52)	.458 (.043)	100 (160)	3.0 (1.36)
918-15H*	902-928	13	16	30/32°	15	5.0 (1.52))	.59 (.055)	125 (200)	4.0 (1.8)

\* H denotes Heavy Duty construction. Heavy duty yagis are ruggedly designed to withstand ice, moisture and harsh environments.

~ Custom frequencies available. Contact ATLC for details.

For Black, add B to end of the model number. Example: 918-2 ESPB.

For White, add W to end of the model number. For example, 918-2 ESPW

## 2.4 GHz Directional Antennas

The P2400 series of antennas are excellent solutions for moderate to high gain directional requirements at 2.4 GHz. These rugged, highly efficient, wide bandwidth antennas deliver clean radiation patterns with high front to back ratios. In addition, the UV stable radome blends easily with surroundings to reduce the visual impact of the antenna.

### Key Features

- ✓ Four levels of gain to choose from.
- ✓ Tubular radome reduces wind load and increases strength in harsh environments.
- ✓ End fired for high efficiency
- ✓ No *Field tuning* is required to obtain maximum performance

**MADE IN THE USA**

### NEW P2400 SERIES MOUNTING ASSEMBLY

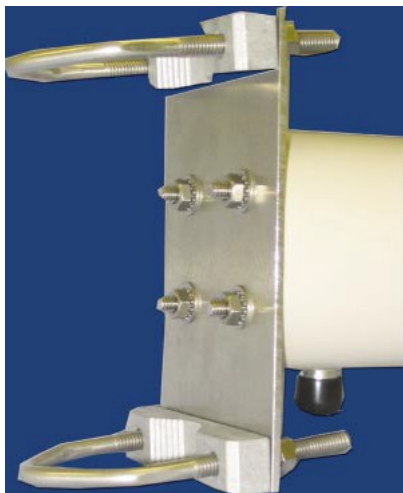

### V-BOLTS AND V-BLOCKS FOR MAST MOUNTING



General Specifications	
Maximum Power: 200 watts	Polarization: Vertical**
Termination: N-Female, Bulkhead	VSWR (50 Ohms): 1.5:1 typical
Mounting Hardware	
Heavy duty mast mounting kits included for up to a 2.0" diameter mast	
** For horizontal polarization, please use the following model numbers: P2406H/P2409H/P2412H/P2415	

Model Number	Frequency Range (MHz)	Gain, dBd Typical	Front to Back Ratio, dB	3 dB Beamwidth E/H	Length, inches	Wind Surface Area, foot <sup>2</sup> (m <sup>2</sup> )	Weight, pounds (kg)
P2406	2375-	6	18	60/90°	4	175	1.5
P2409	2375-	9	18	55/70°	8	150	2
P2412	2375-	12	18	40/45°	16	125	2.5
P2415	2375-	15	18	26/27°	32	100	3

## 5.8 GHz Directional Antennas

The P5808 series of directional antennas are excellent solutions for high gain directional requirements at 5.8 GHz. These rugged, wide bandwidth antennas deliver clean radiation patterns with high front to back ratios. The compact size blends easily with surroundings to reduce visual impact of the antenna.

### Key Features

-  Wideband design provides full coverage with *no field tuning required*.
-  Tubular radome reduces wind load and increases strength in harsh environments



**MADE IN THE USA**

Specifications	P5808
Frequency Range, MHz	5725-5875
Gain, dBi	8
Front to Back Ratio, dB	20
VSWR (50 Ohms) 1.5:1 Bandwidth, GHz	2:1 max, nominal 1.5:1 typical 26 minimum
3 dB Beamwidth, E/H Planes	50/50°
Maximum Power, watts	25*
Termination	SMA Jack, Bulkhead
Polarization	Vertical**
Size, inches	3.2 x 2.5 x 2.5
Mounting	Rear

\*\* For horizontal polarization, please use the following model number P5808H

## Custom FM Broadcast Antennas

Model Number	Center Frequency Range (MHz)	Gain, dBd	Bandwidth MHz	Number of Elements	Beamwidth E/H	Power (watts)	Wind Rating mph/(kph)
FM91-4	88-93*	7	5	4	67/115°	150	100/160
FM96-4	93-98*	7	5	4	67/115°	150	100/160
FM100-4	97-102*	7	5	4	67/115°	150	100/160
FM105-4	102-108*	7	6	4	67/115°	150	100/160

\* Specify center frequency.

## TV/CATV Receiving Antennas

Model Number	Center Frequency Range (MHz)	Gain, dBd	Bandwidth MHz	Number of Elements	Beamwidth E/H	Power (watts)	Wind Rating mph/(kph)
TV RX/TX	2-6*	7	6	5	58/80°	150	100/160
TV RX/TX	7-13*	8	6	5	55/72°	150	100/160
TV RX/TX	14-69*	11	30	10	38/42°	150	100/160

\* Specify center frequency.

## Dipole Array Antennas

Model Number	Frequency Range (MHz)	Gain, dBd	Number of Elements	Beamwidth E/H	Power (watts)	Wind Rating mph/(kph)
D151-2*	144-155	6	2	169/34	150	100/160
D151-4*	147-155	9	4	180/17	150	100/160
D155-2*	152-158	6	2	169/34	150	100/160
D155-4*	152-158	9	4	180/17	150	100/160
D158-2*	154-162	6	2	169/34	150	100/160
D158-4*	154-162	9	4	180/17	150	100/160
D165-2*	161-169	6	2	169/34	150	100/160
D165-4*	161-169	9	4	180/17	150	100/160
D172-2*	168-176	6	2	169/34	150	100/160
D172-4*	168-176	9	4	180/17	150	100/160
D221-4*	218-224	9	4	180/17	150	100/160
D228-4*	224-232	9	4	180/17	150	100/160
D228-8*	224-232	12	8	180/17	150	100/160
D230-4*	225-237	9	4	180/17	150	100/160
D345-4*	340-350	9	4	180/17	150	100/160
D460-4*	450-470	9	4	180/17	150	100/160

\* No mast supplied.

‡ Beamwidth shown is for offset array. Array can be configured for OMNIdirectional (360/34). Subtract 3 dBd from gain figures for an OMNI configuration.



## Yagi antennas VHF Low Band

Model Number	Center Frequency Range (MHz)	Gain, dBd	Bandwidth MHz	Number of Elements	Beamwidth E/H	Power (watts)	Wind Rating mph/(kph)
30-3	30-31*	5	1	3	67/119	150	100/160
35-3	30-40*	5	1	3	67/119	150	100/160
45-3	40-60*	5	2	3	67/119	150	100/160
50-3	49-51*	5	2	3	67/119	150	100/160
70-3	69-72*	5	3	3	67/119	150	100/160
70-4	60-80*	6	3	4	64/97	150	100/160
72-4	70-73*	6	3	4	62/97	150	100/160
81-4	80-82*	6	2	4	63/98	150	100/160

\* Specify center frequency.

## FLEXTRON Portable Communication Antennas

### Example: AXQ 9 SM

Style	Wavelength	Frequency *see chart	Connector **see chart
AX	Q	9	SM

In addition to the straight versions of the "Flextron" antennas, ATLC also offers most modes in right angle/swivel styles. To design this style, please, add an "S" at the end of the model number (ex:AXQ9SMS)

Style/ Straight	Q = 1/4 H = 1/2	Wavelength	Connectors **
AXQ/AXH	2.4-2.5 GHz - ISM Band		SM, SF, TM, RPSM, RTSM, RTM, MM, CL SM, SF, TM, RPSM, RTSM, RTM, MM, CL
AXQ/AXH	902-928 MHz - ISM Band		SM, SF, TM, RPSM, RTSM, RTM, MM, CL SM, SF, TM, RPSM, RTSM, RTM, MM, CL
AXQ/AXH	824-896 MHz - Cellular Band		SM, SF, TM, CL SM, SF, TM, CL
AXQ/AXH	890-960 MHz - GSM Band		SM, SF, TM, CL SM, SF, TM, CL
AXQ/AXH	806-866 MHz - SMR Band		SM, SF, TM, CL SM, SF, TM, CL
AXQ/AXH	450-470 MHz - UHF Band		BM, TM, NM BM, TM, NM

Frequency Codes*	Connector Codes**	ATLC also offers many models that are right angle/swivel and also articulate 90 degrees. To designate this version, please, add an "A" to the end of the model number (Ex. AXQ9TMA)
4 = (450-470)	BM=BNC male	
86 = (806-866)	SM=SMA male	
8 = (824-896)	SF=SMA female	
9 = (890-960)	TM=TNC male	
92 = (902-928)	NM=N male	
24 = (2400-2500)	RPSM=SMA male reverse polarity	
	RTSM=SMA male reverse thread	
	RPTM=TNC male reverse polarity	
	MM=MMCX plug	
	CL = Cable lead w/connector (specify)	

Please call or email for additional technical specs, styles types, connectors and pricing for OEM applications

## Base Station Antennas 2.4 GHz

<i>Model Number</i>	<i>Frequency</i>	<i>Gain, dBi</i>	<i>Degree</i>	<i>Description</i>
ASTG11T	2400-2500	7	120°	Sector Panel
ASTG13T	2400-2500	10	120°	Sector Panel
ASTG1112T	2400-2500	14	120°	Sector Panel
ASTPG19	2400-2500	19	15°	Directional Panel
ASTPG16	2400-2500	16	16°	Directional Panel
ASTG12H	2400-2500	6	180°	Sector Panel
ASTG14H	2400-2500	8	180°	Sector Panel
ASTG112H	2400-2500	11	180°	Sector Panel
ASTPG15	2400-2500	15	22°	Directional Panel
ASTG22	2400-2500	14	33°	Directional Panel
ASTG11	2400-2500	10	60°	Sector Panel
ASTG12	2400-2500	12	60°	Sector Panel
ASTDG16S	2400-2500	16	60°	Sector Panel
ASTG12F	2400-2500	9	90°	Sector Panel
ASTG14F	2400-2500	12	90°	Sector Panel
ASTG112F	2400-2500	15	90°	Sector Panel

## Base Station Antennas 5 GHz

<i>Model Number</i>	<i>Frequency</i>	<i>Gain, dBi</i>	<i>Degree</i>	<i>Description</i>
ASTN6H	5100-5900	10	180°	Sector Panel
ASTJ12H	5700-5900	12	180°	Sector Panel
ASTN6T	5100-5900	12	120°	Sector Panel
ASTJ12T	5700-5900	14	120°	Sector Panel
ASTN6S	5100-5900	14	60°	Sector Panel
ASTJ12S	5700-5900	16	60°	Sector Panel
ASTN6F	5100-5900	13	90°	Sector Panel
ASTJ12F	5700-5900	15	90°	Sector Panel
ASTJ28	5100-5900	18	12°	Directional Panel
ASTJ19	5100-5900	19	15°	Directional Panel
ASTJ48W	5100-5900	22	10°	Directional Panel

## Base Station Antennas Dual Bands

<i>Model Number</i>	<i>Frequency</i>	<i>Gain, dBi</i>	<i>Degree</i>	<i>Description</i>
AST-D1J1	2400-2483 5100-5900	9 9	66° 60°	Sector Panel
ASTFPG11PJ22	2400-2483 5700-5900	9 14	66° 30°	Sector Panel
ASTG6TJ12T	2400-2483 5700-5900	12 14	120° 120°	Sector Panel

## Hardware Mounting Systems

Model Number	Description	Specifications
BK1	V-Bolt Kit	1.25" to 1.625" Max OD
BK2	V-Bolt Kit	1.25" to 2.062" Max OD
BK3	V-Bolt Kit	1.5" to 2.5" Max OD
VBK1	V-Bolt plus V-Block	1.25" to 1.625" Max OD
VBK2	V-Bolt plus V-Block	1.25" to 2.062" Max OD
VBK3	V-Bolt plus V-Block	1.5" to 2.5" Max OD
CBC1	Cross Bar Clamp Kit	1.625" to 2.062" Max OD
CBC2	Cross Bar Clamp Kit	1.25" to 2.0" Max OD
MMK1	"Multi-mount" Side Mount Kit	Rohn 25 Tower Type
MMK2	"Multi-mount" Side Mount Kit	Rohn 45 Tower Type
YSF	Yagi Stacking Frames	Specify Frequency & Gain
Mast	Antenna Mounting Systems	Custom Mast Design
SMK	Yagi Rear Mounting Kit	Large Diameter Poles

All kits are shipped with stainless steel hardware & custom mounting clamps for lasting quality



**MMK1**

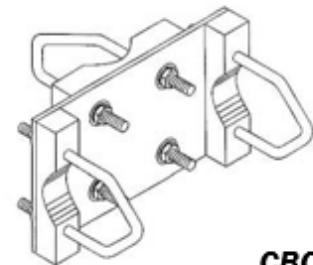

**CBC1**

## Cable Assemblies

Model Number	Cable	Length
CR5NMNM1F	RG58	1 Foot
CR5NMNM10F	RG58	10 Feet
CR5NMNM15F	RG58	15 Feet
CR5NMNM20F	RG58	20 Feet
CL1NMNM10F	LMR195	10 Feet
CL1NMNM20F	LMR195	20 Feet
CL1NMNM30F	LMR195	30 Feet
CL1NMNM40F	LMR195	40 Feet
CL4NMNM25F	LMR400	25 Feet
CL4NMNM50F	LMR400	50 Feet
CL4NMNM75F	LMR400	75 Feet
CL4NMNM100F	LMR400	100 Feet
CR3MMCXSM1F	RG316	1 Foot
CR3MMCXSM2F	RG316	2 Feet
CR3MMCXSM5F	RG316	5 Feet
CR3MMCXSM6F	RG316	6 Feet



Variety of standard and non-standard connectors available

Legend	
C = Cable	<b>CRRXXYYMF</b>
RR = Cable Type	
SS = Connector	
YY = Connector	
M = Length	
F = Feet	

Connector Codes	Cable Types
MMCX = MMCX	LMR400 = L4
NM = N Male	LMR195 = L1
NF = N Female	LMR200 = L2
BM = BNC Male	RG316 = R3
BF = BNC Female	RG58 = R5
TN = TNC Male	

## Mechanical Power Divider (with "N" male connectors)

<i>Model Number</i>	<i>Description</i>	<i>Frequency</i>
MPD46-2NM	2 Port Mechanical Power Divider	450-470
MPD83-2NM	2 Port Mechanical Power Divider	806-866
MPD86-2NM	2 Port Mechanical Power Divider	824-896
MPD91-2NM	2 Port Mechanical Power Divider	902-928
MPD92-2NM	2 Port Mechanical Power Divider	890-960
MPD78-2NM	2 Port Mechanical Power Divider	740-800
MPD24-2NM	2 Port Mechanical Power Divider	2375-2500
MPD46-4NM	4 Port Mechanical Power Divider	450-470
MPD83-4NM	4 Port Mechanical Power Divider	806-866
MPD86-4NM	4 Port Mechanical Power Divider	824-896
MPD91-4NM	4 Port Mechanical Power Divider	902-928
MPD92-4NM	4 Port Mechanical Power Divider	890-960
MPD78-4NM	4 Port Mechanical Power Divider	740-800
MPD24-4NM	4 Port Mechanical Power Divider	2375-2500

**MPD46-2NF**

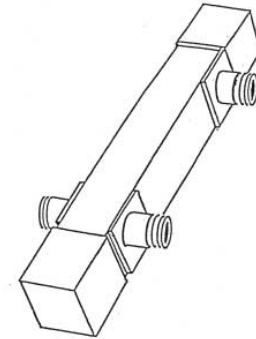

## Mechanical Power Divider (with "N" female connectors)

<i>Model Number</i>	<i>Description</i>	<i>Frequency</i>
MPD46-2NF	2 Port Mechanical Power Divider	450-470
MPD83-2NF	2 Port Mechanical Power Divider	806-866
MPD86-2NF	2 Port Mechanical Power Divider	824-896
MPD91-2NF	2 Port Mechanical Power Divider	902-928
MPD92-2NF	2 Port Mechanical Power Divider	890-960
MPD78-2NF	2 Port Mechanical Power Divider	740-800
MPD24-2NF	2 Port Mechanical Power Divider	2375-2500
MPD46-4NF	4 Port Mechanical Power Divider	450-470
MPD83-4NF	4 Port Mechanical Power Divider	806-866
MPD86-4NF	4 Port Mechanical Power Divider	824-896
MPD91-4NF	4 Port Mechanical Power Divider	902-928
MPD92-4NF	4 Port Mechanical Power Divider	890-960
MPD78-4NF	4 Port Mechanical Power Divider	740-800
MPD24-4NF	4 Port Mechanical Power Divider	2375-2500

**MPD46-4NF**

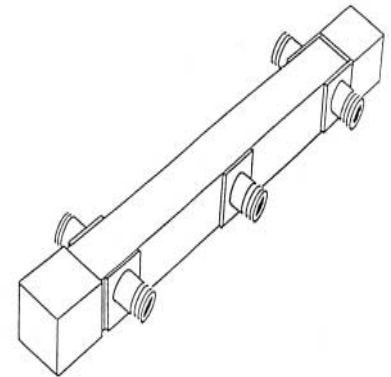

## Yagi Coaxial Power Divider

<i>Model Number</i>	<i>Description</i>	<i>Frequency</i>
YPCD400-2	2 Port Coaxial Power Divider	30-50
YPCD700-2	2 Port Coaxial Power Divider	60-80
YPCD2200-2	2 Port Coaxial Power Divider	218-222
YPCD46-2	2 Port Coaxial Power Divider	450-470
YPCD83-2	2 Port Coaxial Power Divider	806-866
YPCD86-2	2 Port Coaxial Power Divider	824-896
YPCD91-2	2 Port Coaxial Power Divider	902-928
YPCD92-2	2 Port Coaxial Power Divider	890-960
YPCD400-4	4 Port Coaxial Power Divider	30-50
YPCD700-4	4 Port Coaxial Power Divider	60-80
YPCD2200-4	4 Port Coaxial Power Divider	218-222
YPCD46-4	4 Port Coaxial Power Divider	450-470
YPCD83-4	4 Port Coaxial Power Divider	806-866
YPCD86-4	4 Port Coaxial Power Divider	824-896
YPCD91-4	4 Port Coaxial Power Divider	902-928
YPCD92-4	4 Port Coaxial Power Divider	890-960

**YPCD400-2**

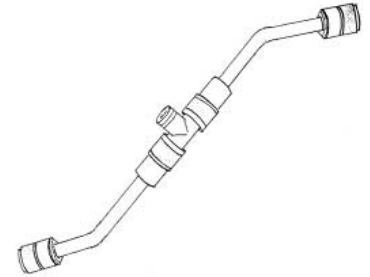

Coaxial, "T" adapter, RG58 coax and "N" male connectors

## Antenna Technologies Limited Company Philosophy



*Our antennas are developed, tested and manufactured with the goal of satisfying the stringent requirements and expectation of the system designer, the integrator and the end user. All products are warranted to be free from defects in workmanship and materials for a one (1) year period from date of purchase.*

*ATLC will work to ensure customer satisfaction through our commitment to deliver quality, performance, durability and value in every antenna we manufacture.*



ANTENNA TECHNOLOGIES LIMITED COMPANY

*ATLC products for military use may be subject to U.S. ITAR EXPORT CONTROLS, an export license may be required.*