



ZL2-F2438

Z-Sensor

CYLINDRICAL PHOTOELECTRIC SENSORS

SICK
Sensor Intelligence.



Illustration may differ



Ordering information

Type	Part no.
ZL2-F2438	1045385

Other models and accessories → www.sick.com/Z-Sensor

Detailed technical data

Features

Sensor/ detection principle	Photoelectric retro-reflective sensor, Dual lens
Dimensions (W x H x D)	13.6 mm x 41.9 mm x 31.7 mm
Housing design (light emission)	Hybrid
Thread diameter (housing)	M18 x 1
Sensing range max.	0.1 m ... 4.8 m ¹⁾
Sensing range	0.1 m ... 3 m ¹⁾
Type of light	Visible red light
Light source	LED ²⁾
Light spot size (distance)	Ø 125 mm (1 m)
Wave length	660 nm
Adjustment	None

¹⁾ Reflector PL80A.

²⁾ Average service life: 100,000 h at T_U = +25 °C.

Mechanics/electronics

Supply voltage	10 V DC ... 30 V DC ¹⁾
Ripple	< 5 V _{pp} ²⁾
Power consumption	20 mA ³⁾
Switching output	PNP
Switching mode	Dark switching

¹⁾ Limit values.

²⁾ May not exceed or fall below U_v tolerances.

³⁾ Without load.

⁴⁾ With light/dark ratio 1:1.

⁵⁾ A = V_S connections reverse-polarity protected.

⁶⁾ D = outputs overcurrent and short-circuit protected.

⁷⁾ Reference voltage: 50 V DC.

Output current I_{\max}.	50 mA
Switching frequency	400 Hz ⁴⁾
Connection type	Male connector M8, 4-pin
Circuit protection	A ⁵⁾ D ⁶⁾
Protection class	III ⁷⁾
Polarisation filter	✓
Housing material	Plastic, Glass fiber reinforced ABS plastic
Enclosure rating	IP67
Items supplied	Mounting nut M18
Ambient operating temperature	-25 °C ... +50 °C
Ambient storage temperature	-40 °C ... +70 °C
UL File No.	NRKH.E189383 & NRKH7.E189383

¹⁾ Limit values.

²⁾ May not exceed or fall below U_V tolerances.

³⁾ Without load.

⁴⁾ With light/dark ratio 1:1.

⁵⁾ A = V_S connections reverse-polarity protected.

⁶⁾ D = outputs overcurrent and short-circuit protected.

⁷⁾ Reference voltage: 50 V DC.

Safety-related parameters

MTTF_D	4,229 years
DC_{avg}	0%

Classifications

ECl@ss 5.0	27270902
ECl@ss 5.1.4	27270902
ECl@ss 6.0	27270902
ECl@ss 6.2	27270902
ECl@ss 7.0	27270902
ECl@ss 8.0	27270902
ECl@ss 8.1	27270902
ECl@ss 9.0	27270902
ETIM 5.0	EC002717
ETIM 6.0	EC002717
UNSPSC 16.0901	39121528

Connection diagram

Connection diagram

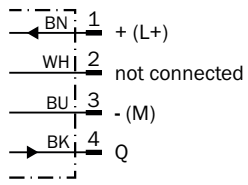

Characteristic curve

ZL1, ZL2, ZL3

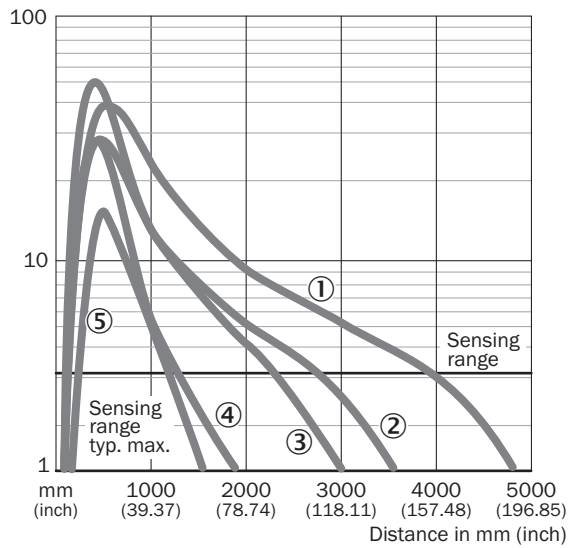

- ① Reflector PL80A
- ② Reflector P250
- ③ Reflector PL40A
- ④ Reflector PL20A
- ⑤ Reflective tape REF-Plus

Sensing range diagram

ZL1, ZL2, ZL3

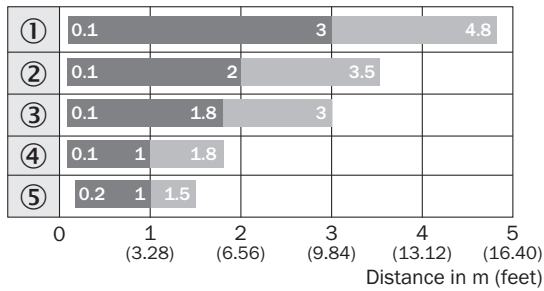

■ Sensing range ■ Sensing range max.

- ① Reflector PL80A
- ② Reflector P250
- ③ Reflector PL40A
- ④ Reflector PL20A
- ⑤ Reflective tape REF-Plus



Dimensional drawing (Dimensions in mm (inch))

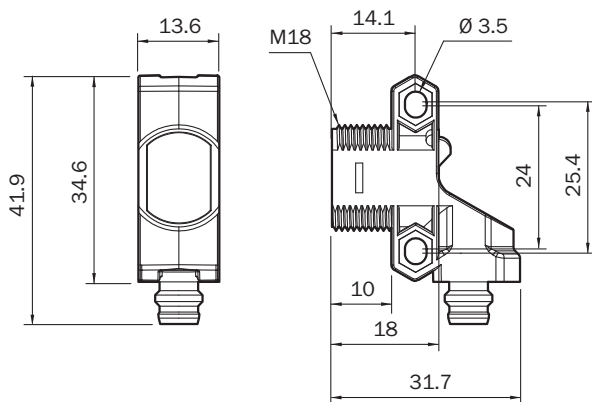



ZT2, ZL2, Connector M8, 4-pin



Recommended accessories

Other models and accessories → www.sick.com/Z-Sensor

	Brief description	Type	Part no.
Reflectors			
	Rectangular, screw connection, 47 mm x 47 mm, PMMA/ABS, Screw-on, 2 hole mounting	P250	5304812
	Rectangular, screw connection, 38 mm x 15 mm, PMMA/ABS, Screw-on, 2 hole mounting	PL20A	1012719

	Brief description	Type	Part no.
	Rectangular, screw connection, 56 mm x 28 mm, PMMA/ABS, Screw-on, 2 hole mounting	PL30A	1002314
	Rectangular, screw connection, 37 mm x 56 mm, PMMA/ABS, Screw-on, 2 hole mounting	PL40A	1012720
	Rectangular, screw connection, 80 mm x 80 mm, PMMA/ABS, Screw-on, 2 hole mounting	PL80A	1003865
	Self-adhesive	REF-IRF-56	5314244
	Round, screw connection, PMMA/ABS, Center hole mounting, screw-on	C110A	5304549

SICK AT A GLANCE

SICK is one of the leading manufacturers of intelligent sensors and sensor solutions for industrial applications. A unique range of products and services creates the perfect basis for controlling processes securely and efficiently, protecting individuals from accidents and preventing damage to the environment.

We have extensive experience in a wide range of industries and understand their processes and requirements. With intelligent sensors, we can deliver exactly what our customers need. In application centers in Europe, Asia and North America, system solutions are tested and optimized in accordance with customer specifications. All this makes us a reliable supplier and development partner.

Comprehensive services complete our offering: SICK LifeTime Services provide support throughout the machine life cycle and ensure safety and productivity.

For us, that is “Sensor Intelligence.”

WORLDWIDE PRESENCE:

Contacts and other locations –www.sick.com