

Description

The ZXCT1080 is a high side current sense monitor with a gain of 10 and a voltage output. Using this device eliminates the need to disrupt the ground plane when sensing a load current.

The wide input voltage range of 60V down to as low as 3V make it suitable for a range of applications; including systems operating from industrial 24 to 28V rails and 48V rails.

The separate supply pin (V_{CC}) allows the device to continue functioning under short circuit conditions, giving an end stop voltage at the output.

The ZXCT1080 has an extended ambient operating temperature range of -40°C to 125°C enabling it to be used in a wide range of applications including automotive.

Features

- 3V to 60V continuous high side voltage
- Accurate high-side current sensing
- -40 to 125°C temperature range
- AEC-Q100 Grade 1 qualified
- Output voltage scaling x10
- 4.5V to 12V V_{CC} range
- Low quiescent current:
 - $80\mu\text{A}$ supply pin
 - $27\mu\text{A}$ I_{S+}
- SOT25 package

Pin Assignments

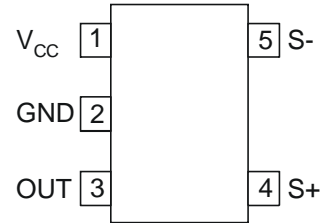

Applications

- Industrial applications current measurement
- Battery management
- Over-current measurement
- Power management
- Automotive current measurement

Typical Application Circuit

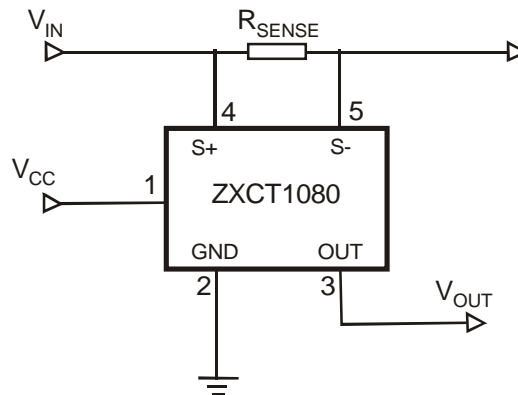

Pin Descriptions

Pin	Name	Description
1	V _{CC}	This is the analogue supply and provides power to internal circuitry
2	GND	Ground pin
3	OUT	Output voltage pin. NMOS source follower with 20µA bias to ground
4	S+	This is the positive input of the current monitor and has an input range from 60V down to 3V. The current through this pin varies with differential sense voltage
5	S-	This is the negative input of the current monitor and has an input range from 60V down to 3V

Absolute Maximum Ratings (T_A = 25°C)

Parameter	Rating	Unit
Continuous voltage on S- and S+	-0.6 and 65	V
Voltage on all other pins	-0.6 and +14	V
Differential sense voltage, V _{SENSE} (Note 1)	800	mV
Operating temperature	-40 to +125	°C
Storage Temperature	-55 to +150	°C
Maximum Junction Temperature	125	°C
Package Power Dissipation (Note 2)	300 (@ T _A = 25°C)	mW

Operation above the absolute maximum rating may cause device failure. Operation at the absolute maximum ratings, for extended periods, may reduce device reliability.

- Note:
1. V_{SENSE} is defined as the differential voltage between S+ and S- pins
 2. Assumes $\theta_{JA} = 420^{\circ}\text{C/W}$

Recommended Operating Conditions

Symbol	Parameter	Min	Max	Units
V _{IN}	Common-mode Sense+ Input Range	3	60	V
V _{CC}	Supply Voltage Range	4.5	12	V
V _{SENSE}	Differential Sense Input Voltage Range	0	0.15	V
V _{OUT}	Output Voltage Range (Note 3)	0	1.5	V
T _A	Ambient Temperature Range	-40	125	°C

- Note:
3. Based on 10x V_{SENSE}

Electrical Characteristics

$T_A = 25^\circ\text{C}$, $V_{IN} = 12\text{V}$, $V_{CC} = 5\text{V}$, V_{SENSE} (Note 4) = 100mV (unless otherwise specified)

Symbol	Parameter	Conditions	T_A	Min (Note 5)	Typ.	Max (Note 5)	Units
I_{CC}	V_{CC} Supply Current	$V_{CC} = 12\text{V}$, $V_{SENSE} = 0\text{V}$ (Note 4)	25°C	40	80	120	μA
			Full range			145	
I_{S+}	S+ Input Current	$V_{SENSE} = 0\text{V}$ (Note 4)	25°C	15	27	42	μA
			Full range			60	
I_{S-}	S- Input Current		25°C	15	40	80	nA
$V_{O(0)}$	Zero V_{SENSE} error (Note 4, 6)		25°C	0		35	mV
$V_{O(10)}$	Output Offset Voltage (Note 7)	$V_{SENSE} = 10\text{mV}$ (Note 4)	25°C	-25		+25	mV
			Full range		-55	+55	
Gain	$\Delta V_{OUT}/\Delta V_{SENSE}$ (Note 4)	$V_{SENSE} = 10\text{mV}$ to 150mV (Note 4)	25°C	9.9	10	10.1	V/V
			Full range		9.8	10.2	
$V_{OUT\ TC}$ (Note 8)	V_{OUT} variation with temperature				30		ppm/°C
A_{CC}	Total output error			-3		3	%
I_{OH}	Output Source Current	$\Delta V_{OUT} = -30\text{mV}$			1		mA
I_{OL}	Output Sink Current	$\Delta V_{OUT} = +30\text{mV}$			20		μA
PSRR	V_{CC} Supply Rejection Ration	$V_{CC} = 4.5\text{V}$ to 12V		54	60		dB
CMRR	Common-Mode Sense Rejection Ratio	$V_{IN} = 60\text{V}$ to 3V		68	80		dB
BW	-3dB small signal bandwidth	$V_{SENSE(AC)} = 10\text{mVpp}$ (Note 4)			500		kHz

- Notes:
- $V_{SENSE} = "V_{S+}" - "V_{S-}"$
 - All Min and Max specifications over full temperature range are guaranteed by design and characterization
 - The ZXCT1080 operates from a positive power rail and the internal voltage-current converter current flow is unidirectional; these result in the output offset voltage for $V_{SENSE} = 0\text{V}$ always being positive.
 - For $V_{SENSE} > 10\text{mV}$, the internal voltage-current converter is fully linear. This enables a true offset to be defined and used. $V_{O(10)}$ is expressed as the variance about an output voltage of 100mV
 - Temperature dependent measurements are extracted from characterization and simulation results.

Typical Characteristics

Test conditions unless otherwise stated: $T_A = 25^\circ\text{C}$, $V_{IN} = 12\text{V}$, $V_{CC} = 5\text{V}$, $V_{SENSE+} = 12\text{V}$, $V_{SENSE} = 100\text{mV}$

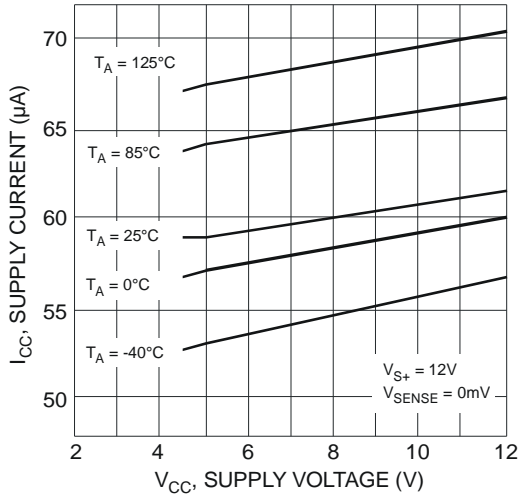

Fig. 1 Supply Current

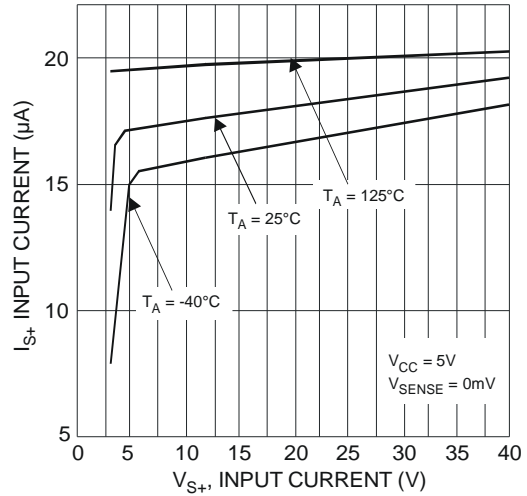

Fig. 2 Input Current

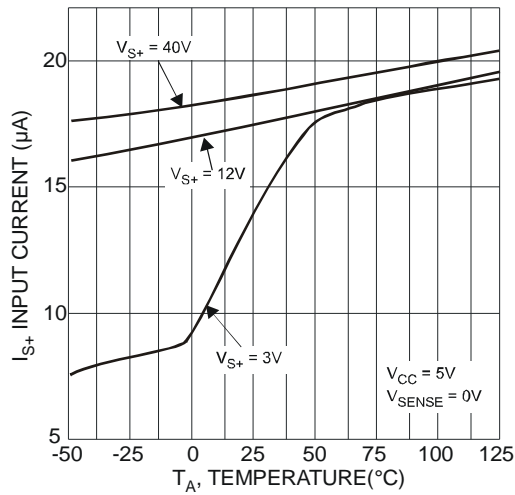

Fig. 3 Input Current

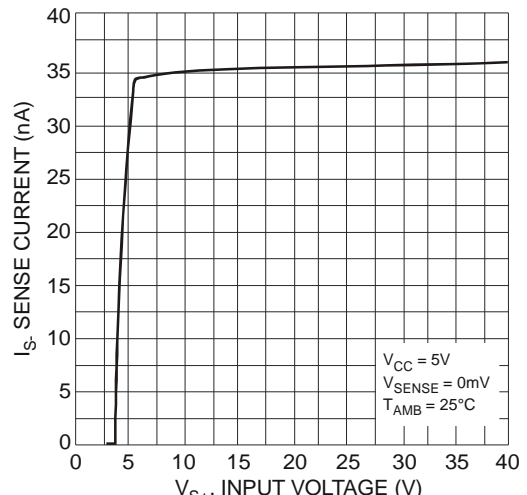

Fig. 4 Sense Current

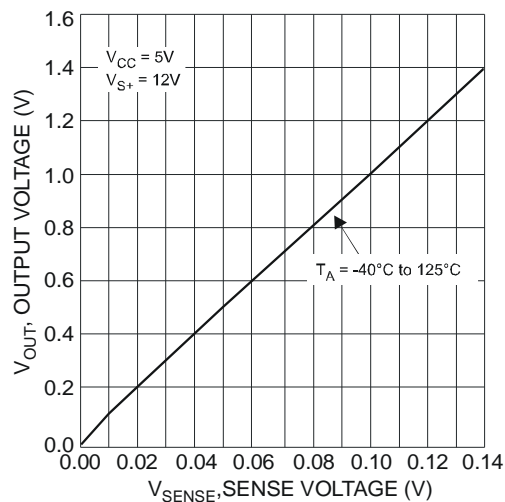

Fig. 5 Output Voltage

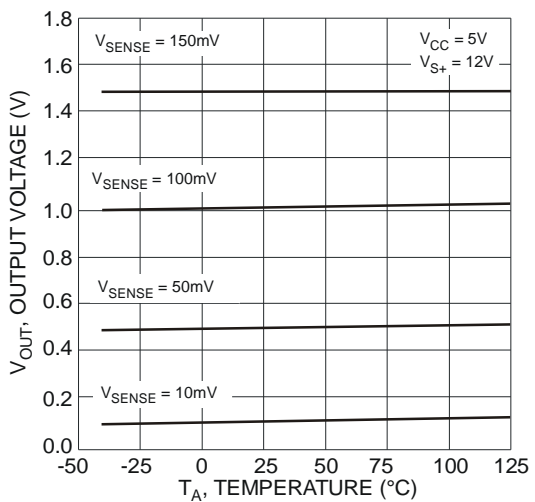

Fig. 6 Output Voltage

Typical Characteristics (cont.)

Test conditions unless otherwise stated: $T_A = 25^\circ\text{C}$, $V_{IN} = 12\text{V}$, $V_{CC} = 5\text{V}$, $V_{SENSE+} = 12\text{V}$, $V_{SENSE} = 100\text{mV}$

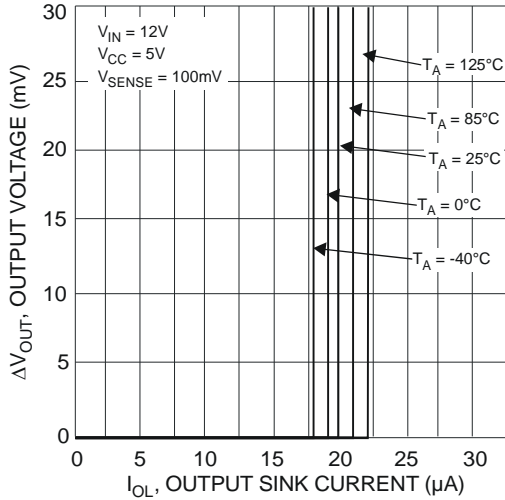

Fig. 7 Output Current Sink

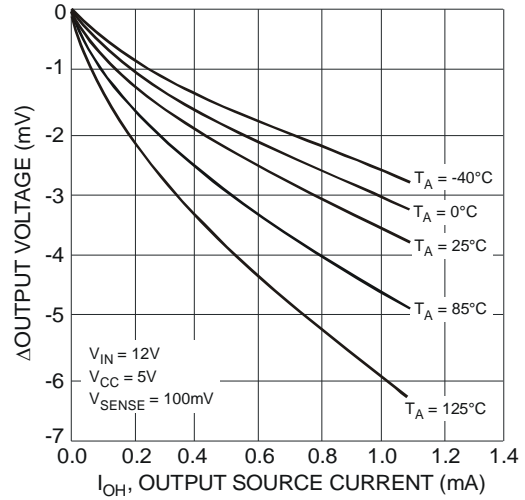

Fig. 8 Output Current Source

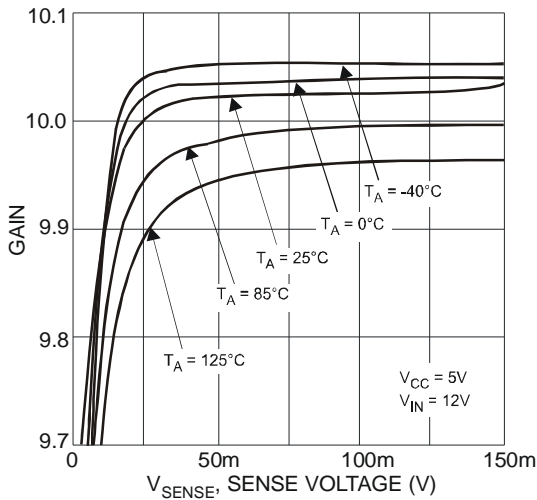

Fig. 9 Differential gain

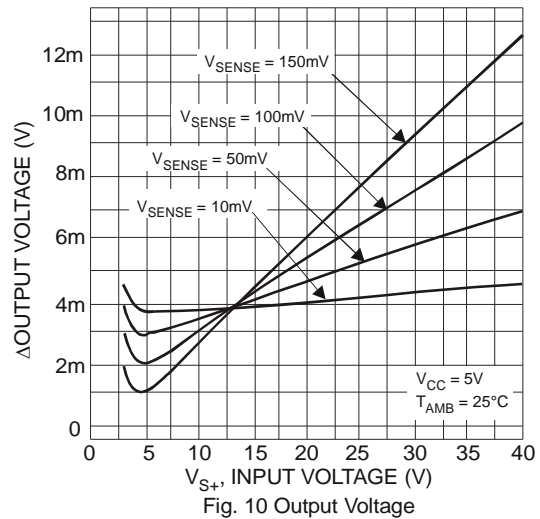

Fig. 10 Output Voltage

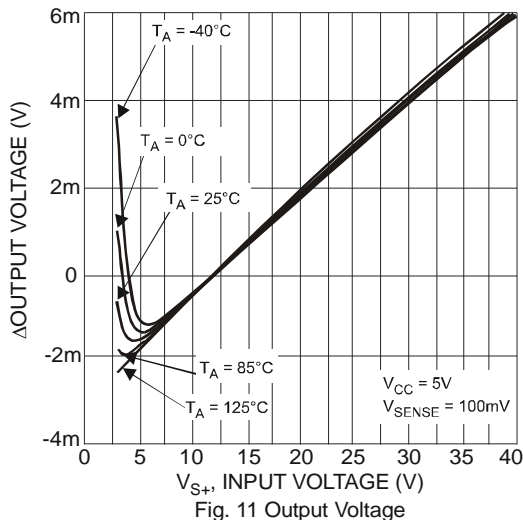

Fig. 11 Output Voltage

Typical Characteristics (cont.)

Test conditions unless otherwise stated: $T_A = 25^\circ\text{C}$, $V_{IN} = 12\text{V}$, $V_{CC} = 5\text{V}$, $V_{SENSE+} = 12\text{V}$, $V_{SENSE} = 100\text{mV}$

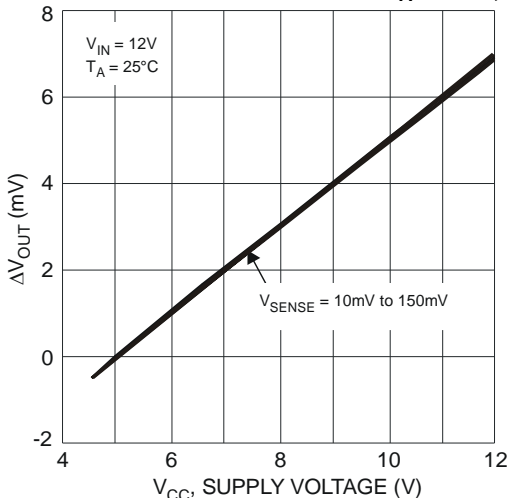

Fig. 12 Normalized Output Voltage

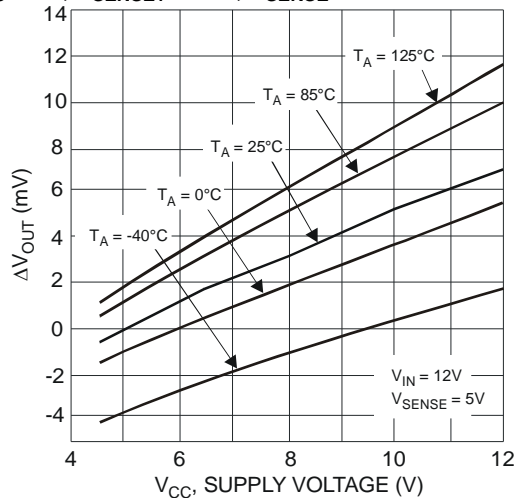

Fig. 13 Normalized Output Voltage

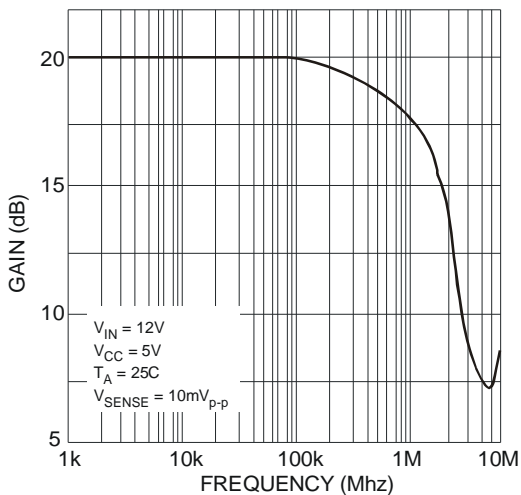

Fig. 14 Small Signal Bandwidth

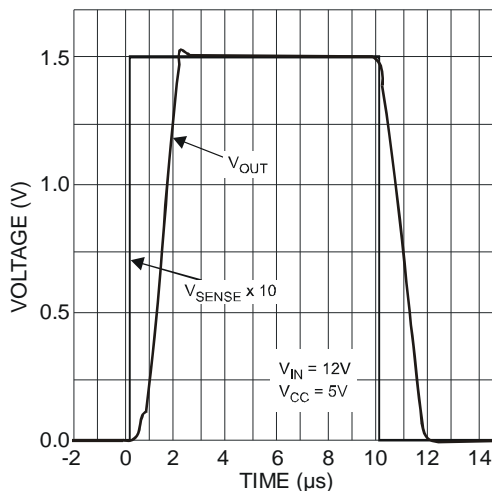

Fig. 15 Large Signal Pulse Response

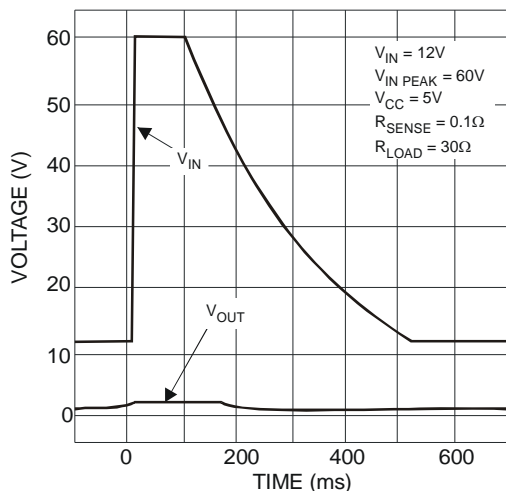

Fig. 16 Load Dump Waveform

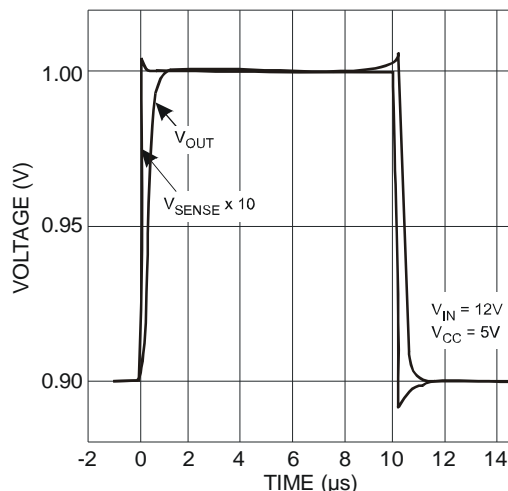

Fig. 17 Small Signal Pulse Response

Typical Characteristics (cont.)

Test conditions unless otherwise stated: $T_A = 25^\circ\text{C}$, $V_{IN} = 12\text{V}$, $V_{CC} = 5\text{V}$, $V_{SENSE+} = 12\text{V}$, $V_{SENSE} = 100\text{mV}$

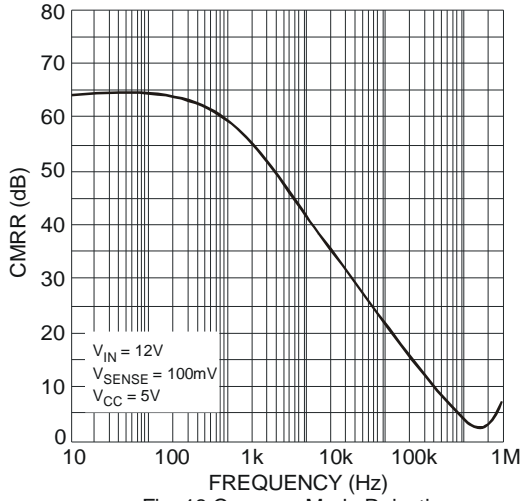

Fig. 18 Common Mode Rejection

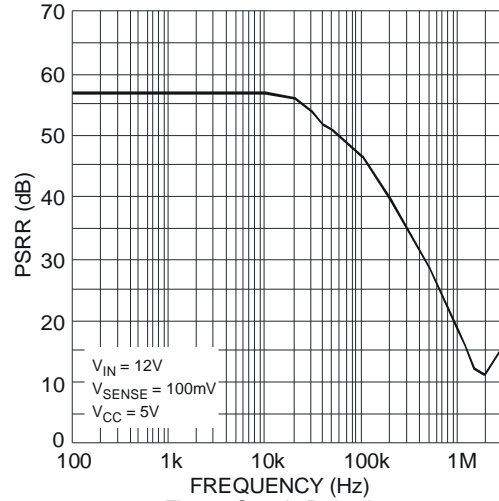

Fig. 19 Supply Rejection

Application Information

The ZXCT1080 has been designed to allow it to operate with 5V supply rails while sensing common mode signals up to 60V. This makes it well suited to a wide range of industrial and power supply monitoring applications that require the interface to 5V systems while sensing much higher voltages.

To allow this its V_{CC} pin can be used independently of S+.

Figure 1 shows the basic configuration of the ZXCT1080.

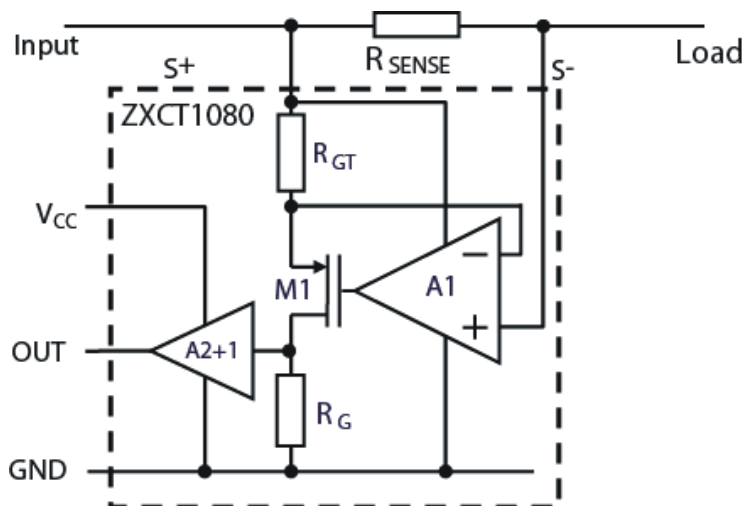

Fig. 20 Typical Configuration of ZXCT1080

Load current from the input is drawn through R_{SENSE} developing a voltage V_{SENSE} across the inputs of the ZXCT1080.

The internal amplifier forces V_{SENSE} across internal resistance R_{GT} causing a current to flow through MOSFET M1. This current is then converted to a voltage by R_G. A ratio of 10:1 between R_G and R_{GT} creates the fixed gain of 10. The output is then buffered by the unity gain buffer.

The gain equation of the ZXCT1080 is:

$$V_{OUT} = I_L R_{SENSE} \frac{R_G}{R_{GT}} \times 1 = I_L \times R_{SENSE} \times 10$$

The maximum recommended differential input voltage, V_{SENSE}, is 150mV; it will however withstand voltages up to 800mV. This can be increased further by the inclusion of a resistor, R_{LIM}, between S- pin and the load; typical value is of the order of 10k.

Application Information (cont.)

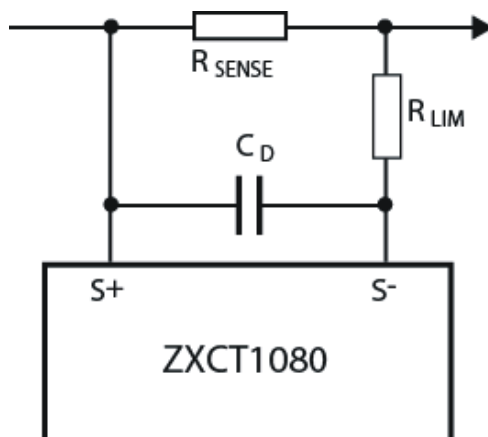

Fig. 21 Protection/Error Sources for ZXCT1080

Capacitor C_D provides high frequency transient decoupling when used with R_{LIM} ; typical values are of the order 10pF.

For best performance R_{SENSE} should be connected as close to the S+ (and SENSE) pins; minimizing any series resistance with R_{SENSE} .

When choosing appropriate values for R_{SENSE} a compromise must be reached between in-line signal loss (including potential power dissipation effects) and small signal accuracy.

Higher values for R_{SENSE} gives better accuracy at low load currents by reducing the inaccuracies due to internal offsets. For best operation the ZXCT1080 has been designed to operate with V_{SENSE} of the order of 50mV to 150mV.

Current monitors' basic configuration is that of a unipolar voltage to current to voltage converter powered from a single supply rail. The internal amplifier at the heart of the current monitor may well have a bipolar offset voltage but the output cannot go negative; this results in current monitors saturating at very low sense voltages.

As a result of this phenomenon the ZXCT1080 has been specified to operate in a linear manner over a V_{SENSE} range of 10mV to 150mV range, however it will still be monotonic down to V_{SENSE} of 0V.

It is for this very reason that Diodes has specified an input offset voltage ($V_{O(10)}$) at 10mV. The output voltage for any V_{SENSE} voltage from 10mV to 150mV can be calculated as follows:

$$V_{OUT} = (V_{SENSE}) \times G + V_{(10)}$$

Alternatively the load current can be expressed as:

$$I_L = \frac{(V_{OUT} - V_{O(10)})}{G \times R_{SENSE}}$$

Ordering Information

Device	AEC-Q100	Package	Part Mark	Reel Size	Tape Width (mm)	Quantity per Reel
ZXCT1080E5TA	Grade 1	SOT25	1080	7	8	3000

Package Outline Dimensions (All Dimensions in mm)

SOT25

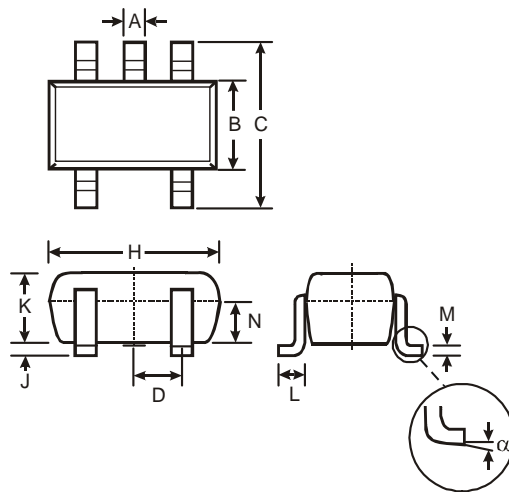

SOT25			
Dim	Min	Max	Typ
A	0.35	0.50	0.38
B	1.50	1.70	1.60
C	2.70	3.00	2.80
D	—	—	0.95
H	2.90	3.10	3.00
J	0.013	0.10	0.05
K	1.00	1.30	1.10
L	0.35	0.55	0.40
M	0.10	0.20	0.15
N	0.70	0.80	0.75
α	0°	8°	—
All Dimensions in mm			

IMPORTANT NOTICE

DIODES INCORPORATED MAKES NO WARRANTY OF ANY KIND, EXPRESS OR IMPLIED, WITH REGARDS TO THIS DOCUMENT, INCLUDING, BUT NOT LIMITED TO, THE IMPLIED WARRANTIES OF MERCHANTABILITY AND FITNESS FOR A PARTICULAR PURPOSE (AND THEIR EQUIVALENTS UNDER THE LAWS OF ANY JURISDICTION).

Diodes Incorporated and its subsidiaries reserve the right to make modifications, enhancements, improvements, corrections or other changes without further notice to this document and any product described herein. Diodes Incorporated does not assume any liability arising out of the application or use of this document or any product described herein; neither does Diodes Incorporated convey any license under its patent or trademark rights, nor the rights of others. Any Customer or user of this document or products described herein in such applications shall assume all risks of such use and will agree to hold Diodes Incorporated and all the companies whose products are represented on Diodes Incorporated website, harmless against all damages.

Diodes Incorporated does not warrant or accept any liability whatsoever in respect of any products purchased through unauthorized sales channel.

Should Customers purchase or use Diodes Incorporated products for any unintended or unauthorized application, Customers shall indemnify and hold Diodes Incorporated and its representatives harmless against all claims, damages, expenses, and attorney fees arising out of, directly or indirectly, any claim of personal injury or death associated with such unintended or unauthorized application.

Products described herein may be covered by one or more United States, international or foreign patents pending. Product names and markings noted herein may also be covered by one or more United States, international or foreign trademarks.

LIFE SUPPORT

Diodes Incorporated products are specifically not authorized for use as critical components in life support devices or systems without the express written approval of the Chief Executive Officer of Diodes Incorporated. As used herein:

A. Life support devices or systems are devices or systems which:

1. are intended to implant into the body, or
2. support or sustain life and whose failure to perform when properly used in accordance with instructions for use provided in the labeling can be reasonably expected to result in significant injury to the user.

B. A critical component is any component in a life support device or system whose failure to perform can be reasonably expected to cause the failure of the life support device or to affect its safety or effectiveness.

Customers represent that they have all necessary expertise in the safety and regulatory ramifications of their life support devices or systems, and acknowledge and agree that they are solely responsible for all legal, regulatory and safety-related requirements concerning their products and any use of Diodes Incorporated products in such safety-critical, life support devices or systems, notwithstanding any devices- or systems-related information or support that may be provided by Diodes Incorporated. Further, Customers must fully indemnify Diodes Incorporated and its representatives against any damages arising out of the use of Diodes Incorporated products in such safety-critical, life support devices or systems.

Copyright © 2011, Diodes Incorporated

www.diodes.com