

Mounting Option

04-.156 (3.96) Dia. Mounting Holes

Contact Detail

524-P.C. Tail .018 Sq.(0.46 Sq.) - Tail LG=.175(4.45)

.156 [3.96] Contact Spacing x .200 [5.08] Row Spacing

THIS IS A C.A.D. GENERATED DRAWING
DO NOT MAKE MANUAL REVISIONS TO MASTER.



ISSUE NUMBER

ORIGINAL

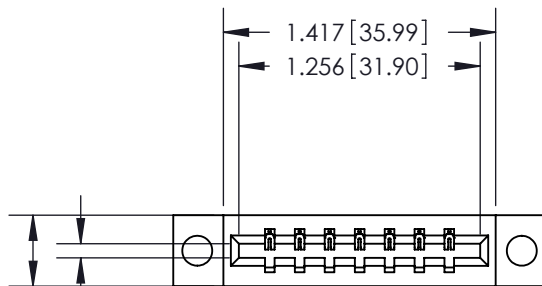

Card Slot Accepts .054 [1.37]
to .070 (1.78) Thick P.C. Board

0.370 [9.40]

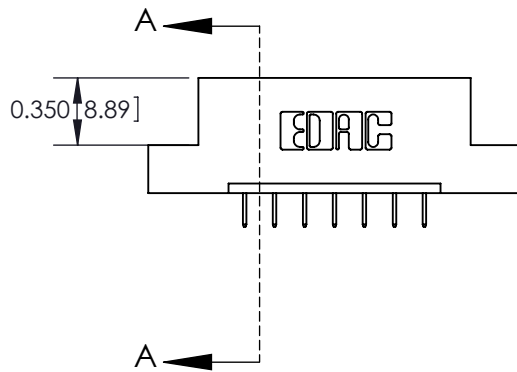

SECTION A-A

See Accompanying Page for:

- Bend Detail
- Mounting Options
- Features and Specifications

333 Series Card Edge Connector

Part Number: 333-007-524-104



EDAC INC
TORONTO, ONTARIO
CANADA

YOUR CONNECTION TO QUALITY & SERVICE

THESE DRAWINGS AND SPECIFICATIONS
ARE THE PROPERTY OF EDAC INC. AND
SHALL NOT BE REPRODUCED, OR COPIED
OR USED AS THE BASIS FOR THE
MANUFACTURE OR SALE OF APPARATUS
WITHOUT WRITTEN PERMISSION.

ACAD REFERENCE NO. 333 ENG MASTER

DRAWN: J.LEE DATE: OCT. 14/09

CHECKED: DATE:

SCALE: NTS SHEET 1 OF 4

DRAWING NUMBER ISSUE

333 Assembly

1



555 Contact Code



556 Contact Code



558 Contact Code



559 Contact Code



560 Contact Code

333 Series Card Edge Connector
Contact Bend Detail



EDAC INC
TORONTO, ONTARIO
CANADA

YOUR CONNECTION TO QUALITY & SERVICE

THESE DRAWINGS AND SPECIFICATIONS
ARE THE PROPERTY OF EDAC INC. AND
SHALL NOT BE REPRODUCED, OR COPIED
OR USED AS THE BASIS FOR THE
MANUFACTURE OR SALE OF APPARATUS
WITHOUT WRITTEN PERMISSION.

ACAD REFERENCE NO. 333 ENG MASTER

DRAWN: J.LEE DATE: OCT. 14/09

CHECKED: DATE:

SCALE: NTS SHEET 2 OF 4

DRAWING NUMBER ISSUE

333 Assembly

1

THIS IS A C.A.D. GENERATED DRAWING
DO NOT MAKE MANUAL REVISIONS TO MASTER.



ISSUE NUMBER

ORIGINAL



Code x01

Code x02

Code x03

Code x04

Code x07

Code x08

Code x12

333 Series Card Edge Connector Mounting Options



EDAC INC
TORONTO, ONTARIO
CANADA

YOUR CONNECTION TO QUALITY & SERVICE

THESE DRAWINGS AND SPECIFICATIONS
ARE THE PROPERTY OF EDAC INC. AND
SHALL NOT BE REPRODUCED, OR COPIED
OR USED AS THE BASIS FOR THE
MANUFACTURE OR SALE OF APPARATUS
WITHOUT WRITTEN PERMISSION.

ACAD REFERENCE NO. 333 ENG MASTER

DRAWN: J.LEE DATE: OCT. 14/09

CHECKED: DATE:

SCALE: NTS SHEET 3 OF 4

DRAWING NUMBER ISSUE

333 Assembly

1



Features

- .156 (3.96) Contact Spacing x .200 (5.08) Row Spacing
- Accepts .062 (1.57) Nominal Thickness P.C. Board
- High Profile Insulator Body .600 (15.24)
- Contact Termination Options include P.C. Tail, Wire Hole, Wire Wrap, 90 Degree, & Extender Board Bends
- Single or Dual Row Configurations
- Variety of Mounting Options, Flush or Offset Lugs
- Accepts Between Contact and In-Contact Polarizing Keys

Specifications

- Insulator Material: Thermoplastic Polyester, UL 94V-0, Colour: Green
- Contact Material: Copper, Nickel, Tin Alloy CA-725
- Contact Plating: Gold on the Mating Area, Tin on the Contact Tails, Nickel Underplate
- Current Rating: 3 Amperes Continuous
- Contact Resistance: 10 Milliohms Maximum
- Dielectric Withstanding Voltage: 1800 V AC rms at Sea Level Between Adjacent Contacts
- Insulation Resistance: 5000 Megohms Minimum
- Operating Temperature: -65 to +105 Degrees C
- Insertion Force: 16 oz (4.45 N) Maximum per Contact Pair when Tested with a .070 (1.78) Thick Gauge
- Withdrawal Force: 1 oz (0.28 N) Minimum per Contact Pair when Tested with a .054 (1.37) Thick Gauge

333 Series Card Edge Connector Features and Specifications		ACAD REFERENCE NO. 333 ENG MASTER	
		DRAWN: J.LEE	DATE: OCT. 14/09
 EDAC INC TORONTO, ONTARIO CANADA YOUR CONNECTION TO QUALITY & SERVICE		CHECKED:	DATE:
		SCALE: NTS	SHEET 4 OF 4
THESE DRAWINGS AND SPECIFICATIONS ARE THE PROPERTY OF EDAC INC. AND SHALL NOT BE REPRODUCED, OR COPIED OR USED AS THE BASIS FOR THE MANUFACTURE OR SALE OF APPARATUS WITHOUT WRITTEN PERMISSION.		DRAWING NUMBER 333 Assembly	ISSUE 1