

# INA597 High-Precision, Wide-Bandwidth e-trim™ Difference Amplifier

## 1 Features

- Low offset voltage: 200  $\mu\text{V}$  (maximum)
- Low offset voltage drift:  $\pm 5 \mu\text{V}/^\circ\text{C}$  (maximum)
- Low noise: 18  $\text{nV}/\sqrt{\text{Hz}}$  at 1 kHz
- Low gain error:  $\pm 0.03\%$  (maximum)
- High common-mode rejection: 88 dB (minimum)
- Wide bandwidth: 2-MHz GBW
- Low quiescent current: 1.1 mA per amplifier
- High slew rate: 18  $\text{V}/\mu\text{s}$
- High capacitive load drive capability: 500 pF
- Wide supply range:
  - Single-supply: 4.5 V to 36 V
  - Dual-supply:  $\pm 2.25 \text{ V}$  to  $\pm 18 \text{ V}$
- Specified temperature range:  $-40^\circ\text{C}$  to  $+125^\circ\text{C}$
- Packages: 8-pin SOIC and VSSOP, 10-pin VSON

## 2 Applications

- [Data acquisition \(DAQ\)](#)
- [Sensor modules and tags for asset tracking](#)
- [Flow transmitter](#)
- [Optical module](#)
- [Power supply module](#)
- [AC drive position feedback](#)
- [Servo drive position feedback](#)
- [Voltage conditioning module](#)

## 3 Description

The INA597 is a low-power, wide-bandwidth, difference amplifier for cost-sensitive applications. The INA597 consists of a precision operational amplifier (op amp) and a precision resistor network. Excellent tracking of resistors maintains gain accuracy and common-mode rejection over temperature. Unique features such as low offset (200  $\mu\text{V}$ , maximum), low offset drift (5  $\mu\text{V}/^\circ\text{C}$  maximum) high slew rate (18  $\text{V}/\mu\text{s}$ ), and high capacitive load drive of up to 500 pF make the INA597 a robust, high-performance difference amplifier for high-voltage industrial applications.

The common-mode range of the internal op amp extends to the negative supply, and enables the device to operate in single-supply applications. The device operates on single (4.5 V to 36 V) or dual supplies ( $\pm 2.25 \text{ V}$  to  $\pm 18 \text{ V}$ ).

The difference amplifier is the foundation of many commonly used circuits. The INA597 provides this circuit function without using an expensive precision resistor network.

### Device Information

PART NUMBER	PACKAGE <sup>(1)</sup>	BODY SIZE (NOM)
INA597	SOIC (8)	4.90 mm × 3.91 mm
	VSON (10)	3.00 mm × 3.00 mm
	VSSOP (8)	3.00 mm × 3.00 mm

- (1) For all available packages, see the package option addendum at the end of the data sheet.

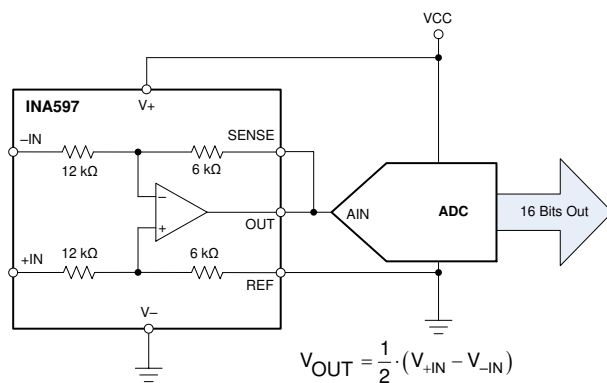

Differential Input Data Acquisition

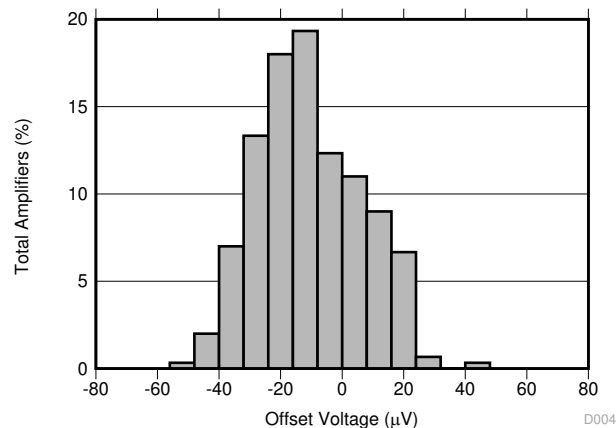

Typical Distribution of Offset Voltage (RTO)  
 $G = 1/2$ ,  $V_S = \pm 18 \text{ V}$



## Table of Contents

<b>1 Features</b> .....	1	8.4 Device Functional Modes.....	22
<b>2 Applications</b> .....	1	<b>9 Application and Implementation</b> .....	23
<b>3 Description</b> .....	1	9.1 Application Information.....	23
<b>4 Revision History</b> .....	2	9.2 Typical Applications.....	23
<b>5 Device Comparison Table</b> .....	3	<b>10 Power Supply Recommendations</b> .....	30
<b>6 Pin Configuration and Functions</b> .....	3	<b>11 Layout</b> .....	30
<b>7 Specifications</b> .....	4	11.1 Layout Guidelines.....	30
7.1 Absolute Maximum Ratings .....	4	11.2 Layout Example.....	31
7.2 ESD Ratings .....	4	<b>12 Device and Documentation Support</b> .....	33
7.3 Recommended Operating Conditions .....	4	12.1 Documentation Support.....	33
7.4 Thermal Information .....	4	12.2 Receiving Notification of Documentation Updates.....	33
7.5 Electrical Characteristics: G = 1/2 .....	5	12.3 Support Resources.....	33
7.6 Electrical Characteristics: G = 2 .....	6	12.4 Trademarks.....	33
7.7 Typical Characteristics.....	7	12.5 Electrostatic Discharge Caution.....	33
<b>8 Detailed Description</b> .....	22	12.6 Glossary.....	33
8.1 Overview.....	22	<b>13 Mechanical, Packaging, and Orderable Information</b> .....	33
8.2 Functional Block Diagram.....	22		
8.3 Feature Description.....	22		

## 4 Revision History

NOTE: Page numbers for previous revisions may differ from page numbers in the current version.

<b>Changes from Revision A (February 2021) to Revision B (April 2021)</b>	<b>Page</b>
• Added DRC package and associated content.....	1

---

<b>Changes from Revision * (August 2019) to Revision A (February 2021)</b>	<b>Page</b>
• Added D package and associated content.....	1
• Added input current (max) to <i>Absolute Maximum Ratings</i> .....	4
• Deleted input voltage (max) from <i>Absolute Maximum Ratings</i> .....	4
• Changed common-mode voltage (min and max) in <i>Electrical Characteristics</i> .....	4
• Added input impedance specifications to <i>Electrical Characteristics</i> .....	4
• Changed Fig. 6-39, <i>Positive Output Voltage vs Output Current (sourcing) G = 1/2</i> , Y-axis unit from $\mu\text{V}$ to $\text{V}$ .....	7

## 5 Device Comparison Table

DEVICE	DESCRIPTION	GAIN EQUATION
INA597	Cost-effective, wide-bandwidth e-trim™ difference amplifier	$G = 0.5 \text{ V/V}$ or $2 \text{ V/V}$
INA592	High-precision, wide-bandwidth e-trim™ difference amplifier	$G = 0.5 \text{ V/V}$ or $2 \text{ V/V}$
INA159	High-speed, precision, gain of 0.2 level translation difference amplifier	$G = 0.2 \text{ V/V}$
INA137	Audio differential line receiver $\pm 6 \text{ dB}$ ( $G = 1/2$ or $2$ )	$G = 0.5 \text{ V/V}$ or $2 \text{ V/V}$
INA132	Low-power, single-supply difference amplifier	$G = 1 \text{ V/V}$
INA819	35- $\mu\text{V}$ offset, 0.4 $\mu\text{V}/^\circ\text{C}$ $V_{OS}$ drift, 8-nV/ $\sqrt{\text{Hz}}$ noise, low-power, precision instrumentation amplifier	$G = 1 + 50 \text{ k}\Omega / \text{RG}$
INA821	35- $\mu\text{V}$ offset, 0.4 $\mu\text{V}/^\circ\text{C}$ $V_{OS}$ drift, 7-nV/ $\sqrt{\text{Hz}}$ noise, high-bandwidth, precision instrumentation amplifier	$G = 1 + 49.4 \text{ k}\Omega / \text{RG}$
INA333	25- $\mu\text{V}$ $V_{OS}$ , 0.1 $\mu\text{V}/^\circ\text{C}$ $V_{OS}$ drift, 1.8-V to 5-V, RRO, 50- $\mu\text{A}$ $I_Q$ , chopper-stabilized INA	$G = 1 + 100 \text{ k}\Omega / \text{RG}$
PGA280	20-mV to $\pm 10\text{-V}$ Programmable Gain IA With 3-V or 5-V Differential Output; Analog Supply up to $\pm 18 \text{ V}$	Digital programmable
PGA112	Precision Programmable Gain Op Amp With SPI	Digital programmable

## 6 Pin Configuration and Functions

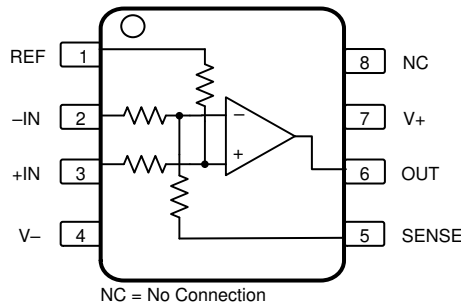

**Figure 6-1. D (8-Pin SOIC) and DGK (8-Pin VSSOP) Packages, Top View**

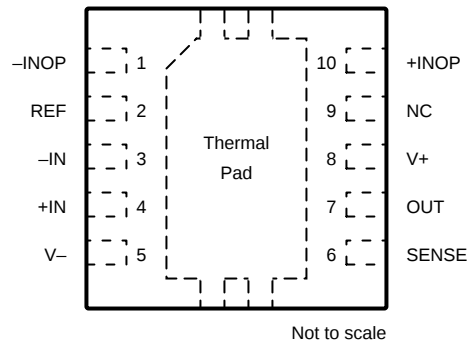

**Figure 6-2. DRC (10-Pin VSON With Thermal Pad) Package, Top View**

**Table 6-1. Pin Functions**

NAME	PIN		I/O	DESCRIPTION
	D (SOIC), DGK (VSSOP)	DRC (VSON)		
+IN	3	4	I	12-k $\Omega$ resistor to noninverting terminal of op amp. Used as positive input in $G = 1/2$ configuration. Used as reference pin in $G = 2$ configuration.
-IN	2	3	I	12-k $\Omega$ resistor to inverting terminal of op amp. Used as negative input in $G = 1/2$ configuration. Connect to output in $G = 2$ configuration.
+INOP	—	10	I	Direct connection to noninverting terminal of op amp
-INOP	—	1	I	Direct connection to inverting terminal of op amp
NC	8	9	—	No internal connection (can be left floating)
OUT	6	7	O	Output
REF	1	2	I	6-k $\Omega$ resistor to noninverting terminal of op amp. Used as reference pin in $G = 1/2$ configuration. Used as positive input in $G = 2$ configuration.
SENSE	5	6	I	6-k $\Omega$ resistor to inverting terminal of op amp. Connect to output in $G = 1/2$ configuration. Used as negative input in $G = 2$ configuration.
V+	7	8	—	Positive (highest) power supply
V-	4	5	—	Negative (lowest) power supply

## 7 Specifications

### 7.1 Absolute Maximum Ratings

over operating free-air temperature range (unless otherwise noted)<sup>(1)</sup>

		MIN	MAX	UNIT
V <sub>±</sub>	Single supply, (V+) to (V–)		36	V
	Dual supply, (V+) – (V–)		±18	V
I <sub>IN</sub>	Input current		10	mA
I <sub>S</sub>	Output short circuit (to ground)	Continuous		
T <sub>A</sub>	Operating temperature	–55	125	°C
T <sub>J</sub>	Junction temperature	–55	125	°C
T <sub>stg</sub>	Storage temperature		150	°C

- (1) Stresses beyond those listed under *Absolute Maximum Ratings* may cause permanent damage to the device. These are stress ratings only, which do not imply functional operation of the device at these or any other conditions beyond those indicated under [Section 7.3](#). Exposure to absolute-maximum-rated conditions for extended periods may affect device reliability.

### 7.2 ESD Ratings

			VALUE	UNIT
V <sub>(ESD)</sub>	Electrostatic discharge	Human-body model (HBM), per ANSI/ESDA/JEDEC JS-001 <sup>(1)</sup>	±500	V
		Charged-device model (CDM), per JEDEC specification JESD22-C101 <sup>(2)</sup>	±1000	

- (1) JEDEC document JEP155 states that 500-V HBM allows safe manufacturing with a standard ESD control process.  
 (2) JEDEC document JEP157 states that 250-V CDM allows safe manufacturing with a standard ESD control process.

### 7.3 Recommended Operating Conditions

over operating free-air temperature range (unless otherwise noted)

		MIN	NOM	MAX	UNIT
V <sub>±</sub>	Supply voltage	Single supply, V <sub>S</sub> = (V+) to (V–)	4.5	36	V
		Dual supply, V <sub>S</sub> = (V+) – (V–)	±2.25	±18	V
T <sub>A</sub>	Specified temperature	–40		125	°C

### 7.4 Thermal Information

THERMAL METRIC <sup>(1)</sup>		INA597			UNIT
		D	DGK	DRC	
		8 PINS	8 PINS	10 PINS	
R <sub>θJA</sub>	Junction-to-ambient thermal resistance	158	115	47.4	°C/W
R <sub>θJC(top)</sub>	Junction-to-case (top) thermal resistance	48.6	52.4	49.6	°C/W
R <sub>θJB</sub>	Junction-to-board thermal resistance	78.7	59.2	21.0	°C/W
ψ <sub>JT</sub>	Junction-to-top characterization parameter	3.9	9.5	0.8	°C/W
ψ <sub>JB</sub>	Junction-to-board characterization parameter	77.3	58.3	20.9	°C/W
R <sub>θJC(bot)</sub>	Junction-to-case (bottom) thermal resistance	N/A	N/A	5.3	°C/W

- (1) For more information about traditional and new thermal metrics, see the [Semiconductor and IC Package Thermal Metrics](#) application report.

## 7.5 Electrical Characteristics: G = 1/2

at  $V_S = \pm 2.25\text{ V to } \pm 18\text{ V}$ ,  $T_A = 25^\circ\text{C}$ ,  $V_{CM} = V_{OUT} = V_S / 2$ ,  $R_L = 10\text{ k}\Omega$  connected to ground, and REF pin connected to ground (unless otherwise noted)

PARAMETER		TEST CONDITIONS		MIN	TYP	MAX	UNIT
<b>OFFSET VOLTAGE (RTO)</b>							
$V_{OS}$	Input offset voltage	$G = 1/2$ , RTO, $T_A = 25^\circ\text{C}$ , $V_S = \pm 2.25\text{ V to } \pm 3\text{ V}$ , $V_{CM} = -3\text{ V}$			$\pm 14$	$\pm 200$	$\mu\text{V}$
		$G = 1/2$ , RTO, $T_A = 25^\circ\text{C}$ , $V_S = \pm 3\text{ V to } \pm 18\text{ V}$ , $V_{CM} = V_S / 2$			$\pm 14$	$\pm 200$	$\mu\text{V}$
$dV_{OS}/dT$	Input offset voltage drift				$\pm 0.7$	$\pm 5.0$	$\mu\text{V}/^\circ\text{C}$
PSRR	Power-supply rejection ratio	$V_S = \pm 3\text{ V to } \pm 18\text{ V}$			$\pm 0.5$	$\pm 5$	$\mu\text{V}/\text{V}$
<b>INPUT VOLTAGE</b>							
$V_{CM}$	Common-mode voltage	$V_{OUT} = 0\text{ V}$		$3[(V^-) - 0.1] - 2V_{REF}$		$3(V^+) - 2V_{REF}$	V
CMRR	Common-mode rejection ratio	$\text{RTO}$ , $3[(V^-) - 0.1\text{ V}] \leq V_{CM} \leq 3[(V^+) - 3\text{ V}]$	$T_A = 25^\circ\text{C}$	88	100		dB
			$T_A = -40^\circ\text{C to } +125^\circ\text{C}$	82	90		dB
		$\text{RTO}$ , $3[(V^+) - 1.5\text{ V}] \leq V_{CM} \leq 3[(V^+)]$	$T_A = 25^\circ\text{C}$	88	100		dB
			$T_A = -40^\circ\text{C to } +125^\circ\text{C}$	72	90		dB
<b>INPUT IMPEDANCE</b>							
$Z_{id}$	Differential	$V_O = 0\text{ V}$			24		k $\Omega$
$Z_{ic}$	Common-mode				9		k $\Omega$
<b>GAIN</b>							
G	Initial				1/2		V/V
GE	Gain error	$V_{OUT} = -10\text{ V to } +10\text{ V}$ , $V_S = \pm 15\text{ V}$			$\pm 0.01$	$\pm 0.03$	%
	Gain error drift <sup>(1)</sup>				$\pm 0.2$	$\pm 0.5$	ppm/ $^\circ\text{C}$
	Gain nonlinearity	$V_{OUT} = -10\text{ V to } +10\text{ V}$ , $V_S = \pm 15\text{ V}$			1		ppm
<b>OUTPUT</b>							
$V_O$	Output voltage swing	Positive rail			170	220	mV
		Negative rail			190	220	mV
$I_{sc}$	Short-circuit current				$\pm 65$		mA
<b>NOISE</b>							
$V_n$	Output voltage noise	$f = 0.1\text{ Hz to } 10\text{ Hz}$ , RTO			3		$\mu\text{V}_{pp}$
	Output voltage noise density	$f = 1\text{ kHz}$ , RTO			18		nV/ $\sqrt{\text{Hz}}$
<b>FREQUENCY RESPONSE</b>							
GBW	Small signal bandwidth	Amplitude = -3 dB			2.0		MHz
SR	Slew rate				18		V/ $\mu\text{s}$
$t_s$	Settling time	To 0.1%	$V_{OUT} = 10\text{-V step}$		1		$\mu\text{s}$
		To 0.01%	$V_{OUT} = 10\text{-V step}$		1.3		$\mu\text{s}$
THD+N	Total harmonic distortion + noise	$f = 1\text{ kHz}$ , $V_{OUT} = 2.8 V_{RMS}$			0.00038		%
	Noise floor, RTO	80-kHz bandwidth, $V_{OUT} = 3.5 V_{RMS}$			-116		dB
$t_{DR}$	Overload recovery time				200		ns

## 7.5 Electrical Characteristics: G = 1/2 (continued)

at  $V_S = \pm 2.25\text{ V}$  to  $\pm 18\text{ V}$ ,  $T_A = 25^\circ\text{C}$ ,  $V_{CM} = V_{OUT} = V_S / 2$ ,  $R_L = 10\text{ k}\Omega$  connected to ground, and REF pin connected to ground (unless otherwise noted)

PARAMETER		TEST CONDITIONS		MIN	TYP	MAX	UNIT
<b>POWER SUPPLY</b>							
$I_Q$	Quiescent current	$I_{OUT} = 0\text{ mA}$	$T_A = 25^\circ\text{C}$		1.1	1.2	mA
			$T_A = -40^\circ\text{C}$ to $+125^\circ\text{C}$			1.5	mA

(1) Specified by wafer test to 95% confidence level.

## 7.6 Electrical Characteristics: G = 2

at  $V_S = \pm 2.25\text{ V}$  to  $\pm 18\text{ V}$ ,  $T_A = 25^\circ\text{C}$ ,  $V_{CM} = V_{OUT} = V_S / 2$ ,  $R_L = 10\text{ k}\Omega$  connected to ground, and REF pin connected to ground (unless otherwise noted)

PARAMETER		TEST CONDITIONS		MIN	TYP	MAX	UNIT
<b>OFFSET VOLTAGE (RTO)</b>							
$V_{OS}$	Input offset voltage	$G = 2$ , RTO, $T_A = 25^\circ\text{C}$ , $V_S = \pm 2.25\text{ V}$ to $\pm 3\text{ V}$ , $V_{CM} = -1.5\text{ V}$			$\pm 28$	$\pm 400$	$\mu\text{V}$
		$G = 2$ , RTO, $T_A = 25^\circ\text{C}$ , $V_S = \pm 3\text{ V}$ to $\pm 18\text{ V}$ , $V_{CM} = V_S / 2$			$\pm 28$	$\pm 400$	$\mu\text{V}$
$dV_{OS}/dT$	Input offset voltage drift				$\pm 1.4$	$\pm 10$	$\mu\text{V}/^\circ\text{C}$
PSRR	Power-supply rejection ratio	$V_S = \pm 2.25\text{ V}$ to $\pm 18\text{ V}$			$\pm 1$	$\pm 5$	$\mu\text{V}/\text{V}$
<b>INPUT VOLTAGE</b>							
$V_{CM}$	Common-mode voltage	$V_{OUT} = 0\text{ V}$		$3/2[(V-) - 0.1] - 0.5V_{REF}$		$3/2(V+) - 0.5V_{REF}$	V
CMRR	Common-mode rejection ratio	$\text{RTO}, 1.5 [(V-) - 0.1\text{ V}] \leq V_{CM} \leq 1.5 [(V+) - 3\text{ V}]$		$T_A = 25^\circ\text{C}$	82	94	dB
				$T_A = -40^\circ\text{C}$ to $+125^\circ\text{C}$	80	84	dB
		$\text{RTO}, 1.5 [(V+) - 1.5\text{ V}] \leq V_{CM} \leq 1.5 [(V+)]$		$T_A = 25^\circ\text{C}$	82	94	dB
				$T_A = -40^\circ\text{C}$ to $+125^\circ\text{C}$	65	84	dB
<b>INPUT IMPEDANCE</b>							
$Z_{id}$	Differential	$V_O = 0\text{ V}$			12		k $\Omega$
$Z_{ic}$	Common-mode				9		k $\Omega$
<b>GAIN</b>							
G	Initial				2		V/V
GE	Gain error	$V_{OUT} = -10\text{ V}$ to $+10\text{ V}$ , $V_S = \pm 15\text{ V}$			$\pm 0.01$	$\pm 0.03$	%
	Gain error drift <sup>(1)</sup>				$\pm 0.25$	$\pm 0.5$	ppm/ $^\circ\text{C}$
	Gain nonlinearity	$V_{OUT} = -10\text{ V}$ to $+10\text{ V}$ , $V_S = \pm 15\text{ V}$			1		ppm
<b>OUTPUT</b>							
$V_O$	Output voltage swing	Positive rail			130	180	mV
		Negative rail			140	180	mV
$I_{SC}$	Short-circuit current				$\pm 65$		mA
<b>NOISE</b>							
$V_n$	Output voltage noise	$f = 0.1\text{ Hz}$ to $10\text{ Hz}$ , RTO			6		$\mu\text{V}_{pp}$
	Output voltage noise density	$f = 1\text{ kHz}$ , RTO			36		$\text{nV}/\sqrt{\text{Hz}}$
<b>FREQUENCY RESPONSE</b>							
GBW	Small signal bandwidth	Amplitude = $-3\text{ dB}$			0.8		MHz
SR	Slew rate				18		V/ $\mu\text{s}$
$t_S$	Settling time	To 0.1%	$V_{OUT} = 10\text{-V step}$		1.0		$\mu\text{s}$
		To 0.01%	$V_{OUT} = 10\text{-V step}$		1.7		$\mu\text{s}$

## 7.6 Electrical Characteristics: G = 2 (continued)

at  $V_S = \pm 2.25\text{ V}$  to  $\pm 18\text{ V}$ ,  $T_A = 25^\circ\text{C}$ ,  $V_{CM} = V_{OUT} = V_S / 2$ ,  $R_L = 10\text{ k}\Omega$  connected to ground, and REF pin connected to ground (unless otherwise noted)

PARAMETER		TEST CONDITIONS		MIN	TYP	MAX	UNIT
THD+N	Total harmonic distortion + noise	$f = 1\text{ kHz}$ , $V_{OUT} = 2.8\text{ V}_{RMS}$		0.00066			%
	Noise floor, RTO	80-kHz bandwidth, $V_{OUT} = 3.5\text{ V}_{RMS}$		-110			dB
$t_{DR}$	Overload recovery time			200			ns
<b>POWER SUPPLY</b>							
$I_Q$	Quiescent current	$I_{OUT} = 0\text{ mA}$	$T_A = 25^\circ\text{C}$	1.1		1.2	mA
			$T_A = -40^\circ\text{C}$ to $+125^\circ\text{C}$			1.5	mA

(1) Specified by wafer test to 95% confidence level.

## 7.7 Typical Characteristics

at  $T_A = 25^\circ\text{C}$ ,  $V_S = \pm 18\text{ V}$ ,  $V_{CM} = V_{OUT} = V_S / 2$ ,  $R_L = 10\text{ k}\Omega$ , REF pin connected to ground,  $G = 1/2$  (unless otherwise noted)

**Table 7-1. Table of Graphs**

DESCRIPTION	FIGURE
Typical Distribution of Offset Voltage (RTO) $G = 1/2$ , $V_S = \pm 2.25\text{ V}$	<a href="#">Figure 7-1</a>
Typical Distribution of Offset Voltage (RTO) $G = 2$ , $V_S = \pm 2.25\text{ V}$	<a href="#">Figure 7-2</a>
Typical Distribution of Offset Voltage (RTO) $G = 1/2$ , $V_S = \pm 18\text{ V}$	<a href="#">Figure 7-3</a>
Typical Distribution of Offset Voltage (RTO) $G = 2$ , $V_S = \pm 18\text{ V}$	<a href="#">Figure 7-4</a>
Typical Distribution of Offset Voltage Drift (RTO) $G = 1/2$	<a href="#">Figure 7-5</a>
Typical Distribution of Offset Voltage Drift (RTO) $G = 2$	<a href="#">Figure 7-6</a>
Output Offset Voltage vs Temperature $G = 1/2$	<a href="#">Figure 7-7</a>
Output Offset Voltage vs Temperature $G = 2$	<a href="#">Figure 7-8</a>
Offset Voltage vs Common-Mode Voltage $G = 1/2$	<a href="#">Figure 7-9</a>
Offset Voltage vs Common-Mode Voltage $G = 2$	<a href="#">Figure 7-10</a>
Input Bias Current vs Temperature $G = 1/2$ and $G = 2$	<a href="#">Figure 7-11</a>
Input Offset Current vs Temperature	<a href="#">Figure 7-12</a>
Input Bias Current vs Common Mode Voltage $G = 1/2$	<a href="#">Figure 7-13</a>
Input Bias Current vs Common Mode Voltage $G = 2$	<a href="#">Figure 7-14</a>
Typical CMRR Distribution $G = 1/2$ , $V_S = \pm 2.25\text{ V}$	<a href="#">Figure 7-15</a>
Typical CMRR Distribution $G = 2$ , $V_S = \pm 2.25\text{ V}$	<a href="#">Figure 7-16</a>
Typical CMRR Distribution $G = 1/2$ , $V_S = \pm 18\text{ V}$	<a href="#">Figure 7-17</a>
Typical CMRR Distribution $G = 2$ , $V_S = \pm 18\text{ V}$	<a href="#">Figure 7-18</a>
CMRR vs Temperature $G = 1/2$	<a href="#">Figure 7-19</a>
CMRR vs Temperature $G = 2$	<a href="#">Figure 7-20</a>
Common-Mode Rejection Ratio vs Frequency (RTI) $G = 1/2$ and $2$	<a href="#">Figure 7-21</a>
Maximum Output Voltage vs Frequency	<a href="#">Figure 7-22</a>
PSRR vs Temperature $G = 1/2$	<a href="#">Figure 7-23</a>
PSRR vs Temperature $G = 2$	<a href="#">Figure 7-24</a>
PSRR vs Frequency (RTI) $G = 1/2$	<a href="#">Figure 7-25</a>
PSRR vs Frequency (RTI) $G = 2$	<a href="#">Figure 7-26</a>
Typical Distribution of Gain Error $G = 1/2$ , $V_S = \pm 2.25\text{ V}$	<a href="#">Figure 7-27</a>
Typical Distribution of Gain Error $G = 2$ , $V_S = \pm 2.25\text{ V}$	<a href="#">Figure 7-28</a>
Gain Error vs Temperature $G = 1/2$	<a href="#">Figure 7-29</a>
Gain Error vs Temperature $G = 2$	<a href="#">Figure 7-30</a>
Closed-Loop Gain vs Frequency $G = 1/2$	<a href="#">Figure 7-31</a>
Closed-Loop Gain vs Frequency $G = 2$	<a href="#">Figure 7-32</a>
Voltage Noise Spectral Density vs Frequency (RTI) $G = 1/2$	<a href="#">Figure 7-33</a>

## 7.7 Typical Characteristics

at  $T_A = 25^\circ\text{C}$ ,  $V_S = \pm 18\text{ V}$ ,  $V_{CM} = V_{OUT} = V_S / 2$ ,  $R_L = 10\text{ k}\Omega$ , REF pin connected to ground,  $G = 1/2$  (unless otherwise noted)

**Table 7-1. Table of Graphs (continued)**

DESCRIPTION	FIGURE
Voltage Noise Spectral Density vs Frequency (RTI) $G = 2$	<a href="#">Figure 7-34</a>
0.1-Hz to 10-Hz RTI Voltage Noise $G = 1/2$	<a href="#">Figure 7-35</a>
0.1-Hz to 10-Hz RTI Voltage Noise $G = 2$	<a href="#">Figure 7-36</a>
Integrated Output Voltage Noise vs Noise Bandwidth $G = 1/2$	<a href="#">Figure 7-37</a>
Integrated Output Voltage Noise vs Noise Bandwidth $G = 2$	<a href="#">Figure 7-38</a>
Positive Output Voltage vs Output Current (sourcing) $G = 1/2$	<a href="#">Figure 7-39</a>
Positive Output Voltage vs Output Current (sourcing) $G = 2$	<a href="#">Figure 7-40</a>
Negative Output Voltage vs Output Current (sinking) $G = 1/2$	<a href="#">Figure 7-41</a>
Negative Output Voltage vs Output Current (sinking) $G = 2$	<a href="#">Figure 7-42</a>
Settling Time $G = 1/2$	<a href="#">Figure 7-43</a>
Settling Time $G = 2$	<a href="#">Figure 7-44</a>
Large Signal Step Response $G = 1/2$	<a href="#">Figure 7-45</a>
Large Signal Step Response $G = 2$	<a href="#">Figure 7-46</a>
Slew Rate over Temperature	<a href="#">Figure 7-47</a>
Overload Recovery (Normalized to 0V)	<a href="#">Figure 7-48</a>
Small-Signal Overshoot vs Capacitive Load $G = 1/2$	<a href="#">Figure 7-49</a>
Small-Signal Overshoot vs Capacitive Load $G = 2$	<a href="#">Figure 7-50</a>
Small-Signal Step Response $G = 1/2$	<a href="#">Figure 7-51</a>
Small-Signal Step Response $G = 2$	<a href="#">Figure 7-52</a>
THD+N vs Frequency $G = 1/2$	<a href="#">Figure 7-53</a>
THD+N vs Frequency $G = 2$	<a href="#">Figure 7-54</a>
THD+N Ratio vs Output Amplitude $G = 1/2$	<a href="#">Figure 7-55</a>
THD+N Ratio vs Output Amplitude $G = 2$	<a href="#">Figure 7-56</a>
Supply Current vs Temperature $G = 1/2$	<a href="#">Figure 7-57</a>
Supply Current vs Temperature $G = 2$	<a href="#">Figure 7-58</a>
Supply Current vs Supply Voltage $G = 1/2$	<a href="#">Figure 7-59</a>
Supply Current vs Supply Voltage $G = 2$	<a href="#">Figure 7-60</a>
Short Circuit Current vs Temperature $G = 1/2$	<a href="#">Figure 7-61</a>
Short Circuit Current vs Temperature $G = 2$	<a href="#">Figure 7-62</a>
Differential-Mode EMI Rejection Ratio $G = 1/2$	<a href="#">Figure 7-63</a>
Differential-Mode EMI Rejection Ratio $G = 2$	<a href="#">Figure 7-64</a>
Common-Mode EMI Rejection Ratio $G = 1/2$	<a href="#">Figure 7-65</a>
Common-Mode EMI Rejection Ratio $G = 2$	<a href="#">Figure 7-66</a>
Input Common-Mode Voltage vs Output Voltage $G = 1/2$ , Bipolar Supply	<a href="#">Figure 7-67</a>
Input Common-Mode Voltage vs Output Voltage $G = 2$ , Bipolar Supply	<a href="#">Figure 7-68</a>
Input Common-Mode Voltage vs Output Voltage $G = 1/2$ , 5-V Supply	<a href="#">Figure 7-69</a>
Input Common-Mode Voltage vs Output Voltage $G = 2$ , 5-V Supply	<a href="#">Figure 7-70</a>
Input Common-Mode Voltage vs Output Voltage $G = 1/2$ , 36-V Supply	<a href="#">Figure 7-71</a>
Input Common-Mode Voltage vs Output Voltage $G = 2$ , 36-V Supply	<a href="#">Figure 7-72</a>
Closed-Loop Output Impedance vs Frequency	<a href="#">Figure 7-73</a>



### 7.7 Typical Characteristics (continued)

at  $T_A = 25^\circ\text{C}$ ,  $V_S = \pm 18\text{ V}$ ,  $V_{CM} = V_{OUT} = V_S / 2$ ,  $R_L = 10\text{ k}\Omega$ , REF pin connected to ground,  $G = 1/2$  (unless otherwise noted)

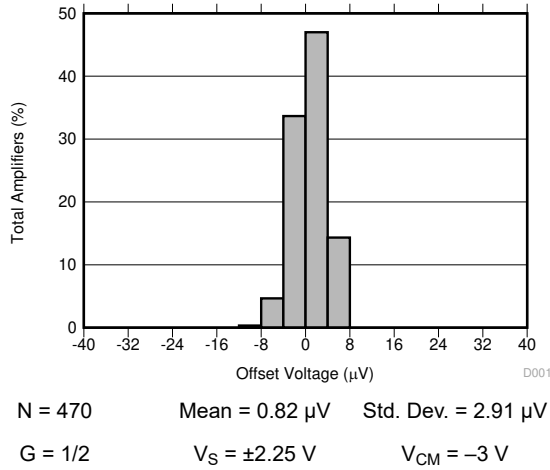

**Figure 7-1. Typical Distribution of Offset Voltage (RTO)**

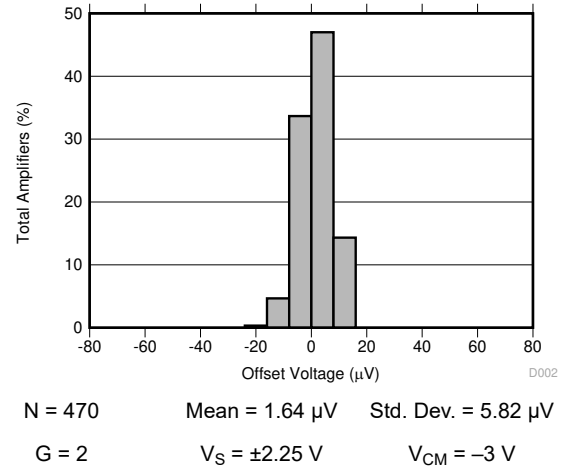

**Figure 7-2. Typical Distribution of Offset Voltage (RTO)**

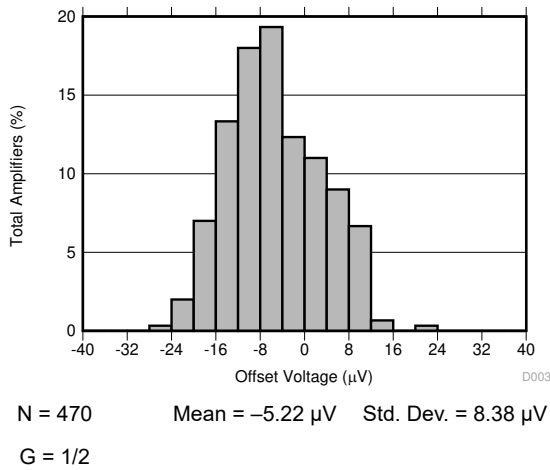

**Figure 7-3. Typical Distribution of Offset Voltage (RTO)**

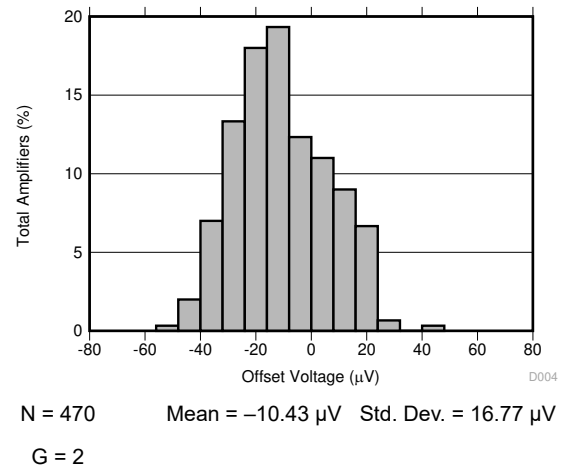

**Figure 7-4. Typical Distribution of Offset Voltage (RTO)**

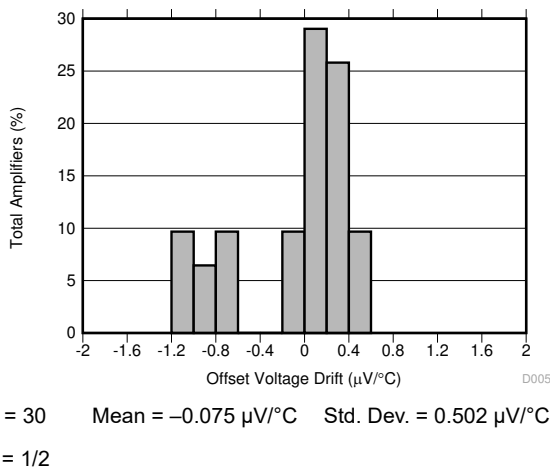

**Figure 7-5. Typical Distribution of Offset Voltage Drift (RTO)**

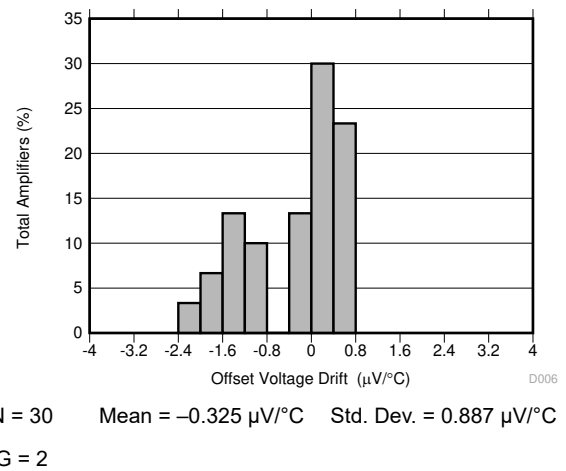

**Figure 7-6. Typical Distribution of Offset Voltage Drift (RTO)**

### 7.7 Typical Characteristics (continued)

at  $T_A = 25^\circ\text{C}$ ,  $V_S = \pm 18\text{ V}$ ,  $V_{CM} = V_{OUT} = V_S / 2$ ,  $R_L = 10\text{ k}\Omega$ , REF pin connected to ground,  $G = 1/2$  (unless otherwise noted)

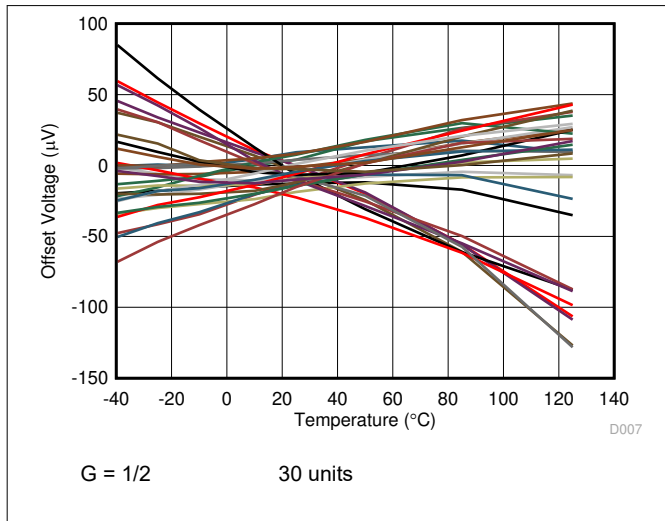

**Figure 7-7. Output Offset Voltage vs Temperature**

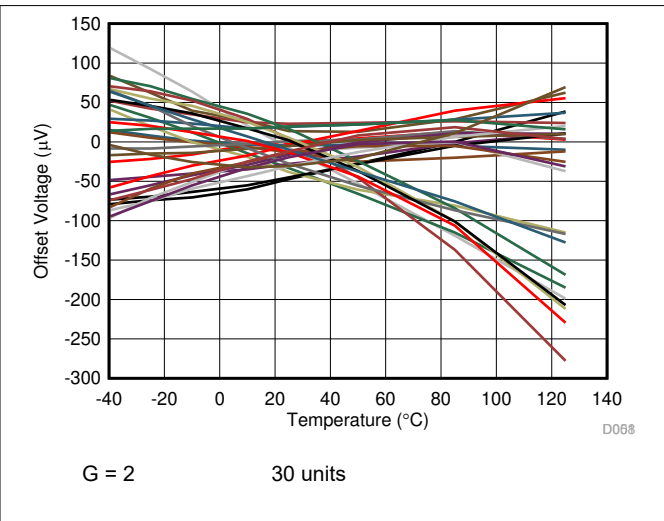

**Figure 7-8. Output Offset Voltage vs Temperature**

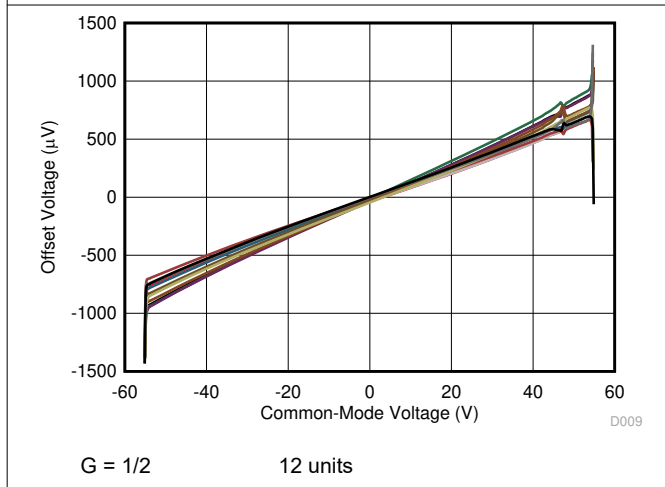

**Figure 7-9. Offset Voltage vs Common-Mode Voltage**

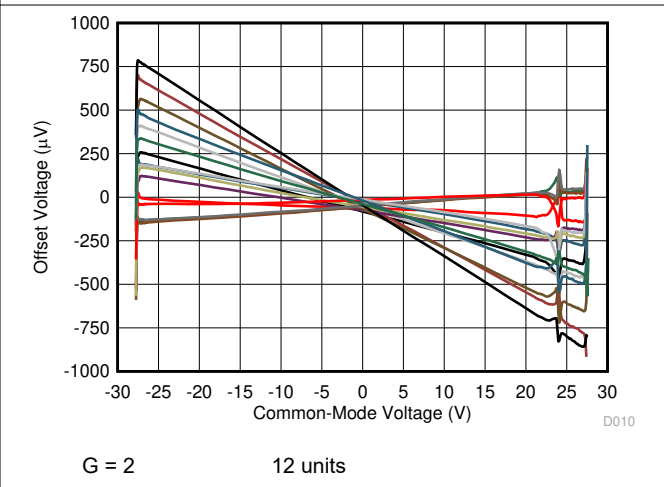

**Figure 7-10. Offset Voltage vs Common-Mode Voltage**

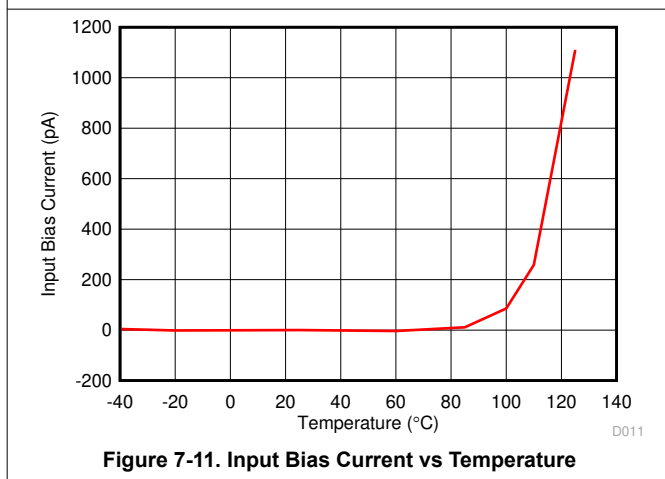

**Figure 7-11. Input Bias Current vs Temperature**

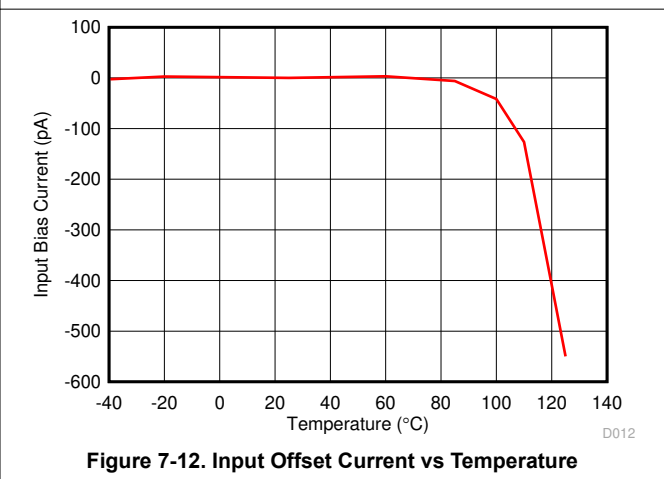

**Figure 7-12. Input Offset Current vs Temperature**

### 7.7 Typical Characteristics (continued)

at  $T_A = 25^\circ\text{C}$ ,  $V_S = \pm 18\text{ V}$ ,  $V_{CM} = V_{OUT} = V_S / 2$ ,  $R_L = 10\text{ k}\Omega$ , REF pin connected to ground,  $G = 1/2$  (unless otherwise noted)

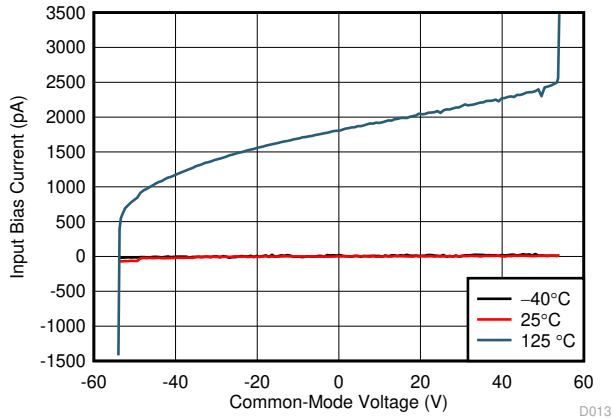

$G = 1/2$

**Figure 7-13. Input Bias Current vs Common-Mode Voltage**

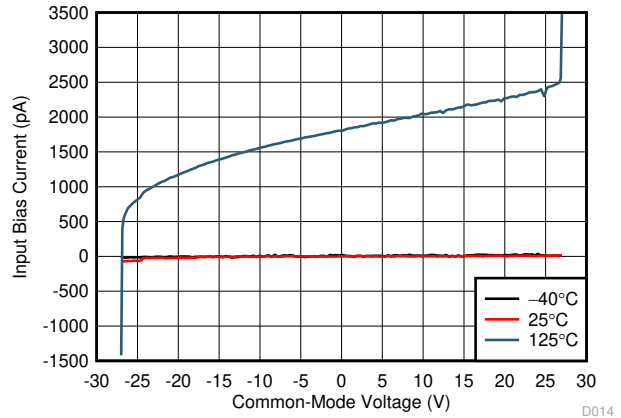

$G = 2$

**Figure 7-14. Input Bias Current vs Common-Mode Voltage**

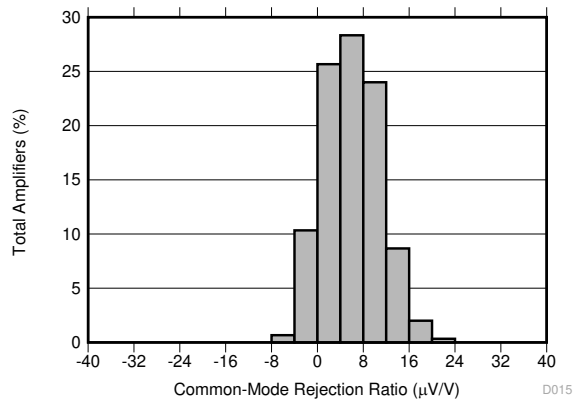

$N = 470$  Mean =  $6.01\ \mu\text{V/V}$  Std. Dev. =  $4.85\ \mu\text{V/V}$   
 $G = 1/2$   $V_S = \pm 2.25\text{ V}$

**Figure 7-15. Typical CMRR Distribution**

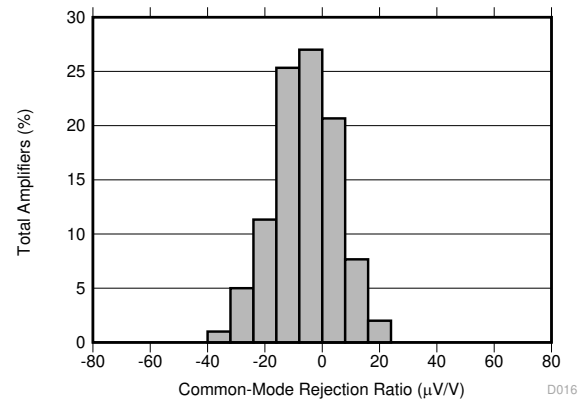

$N = 470$  Mean =  $-6.22\ \mu\text{V/V}$  Std. Dev. =  $10.74\ \mu\text{V/V}$   
 $G = 2$   $V_S = \pm 2.25\text{ V}$

**Figure 7-16. Typical CMRR Distribution**

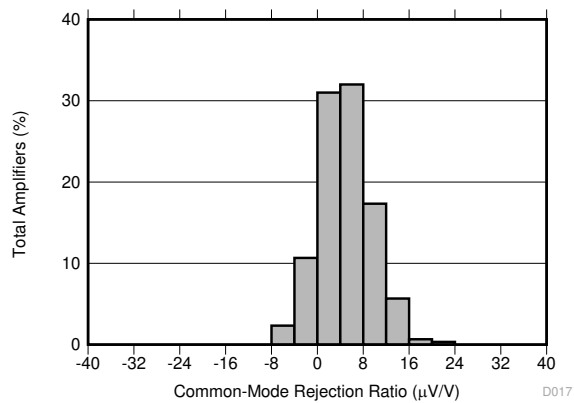

$N = 470$  Mean =  $4.86\ \mu\text{V/V}$  Std. Dev. =  $4.75\ \mu\text{V/V}$   
 $G = 1/2$

**Figure 7-17. Typical CMRR Distribution**

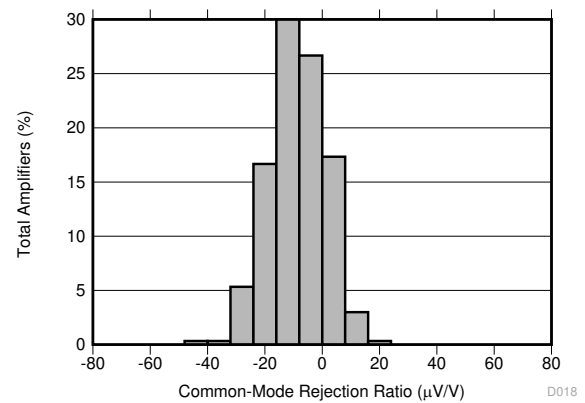

$N = 470$  Mean =  $-8.64\ \mu\text{V/V}$  Std. Dev. =  $9.70\ \mu\text{V/V}$   
 $G = 2$

**Figure 7-18. Typical CMRR Distribution**

### 7.7 Typical Characteristics (continued)

at  $T_A = 25^\circ\text{C}$ ,  $V_S = \pm 18\text{ V}$ ,  $V_{CM} = V_{OUT} = V_S / 2$ ,  $R_L = 10\text{ k}\Omega$ , REF pin connected to ground,  $G = 1/2$  (unless otherwise noted)

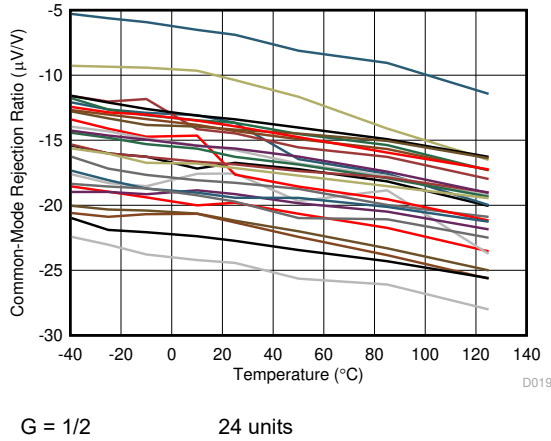

**Figure 7-19. CMRR vs Temperature**

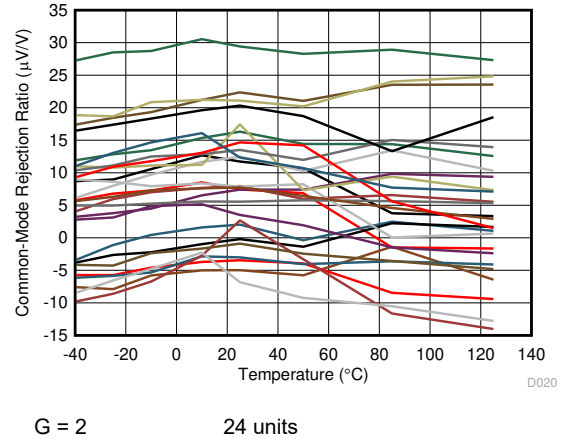

**Figure 7-20. CMRR vs Temperature**

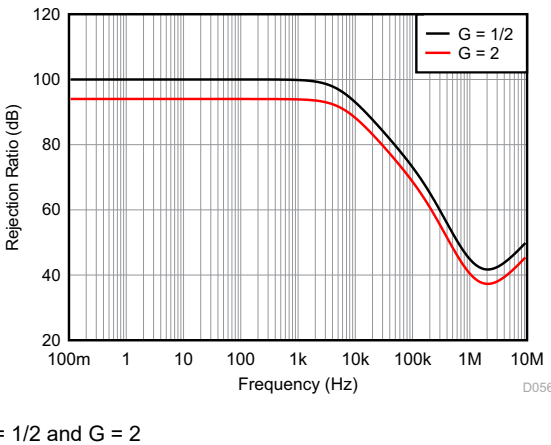

**Figure 7-21. Common-Mode Rejection Ratio vs Frequency, Referred-to-Input**

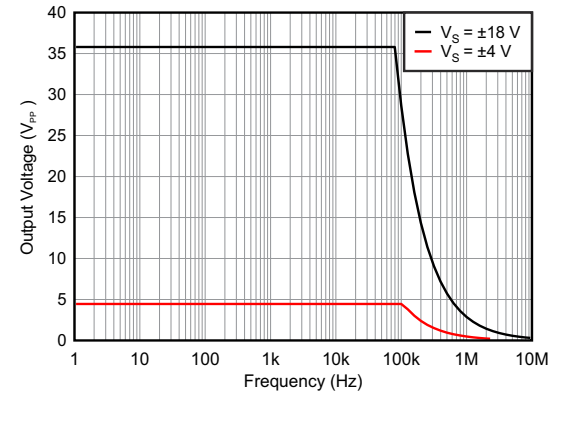

**Figure 7-22. Maximum Output Voltage vs Frequency**

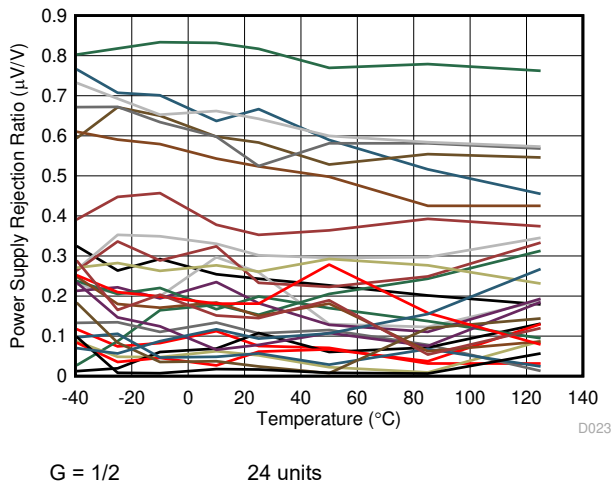

**Figure 7-23. PSRR vs Temperature**

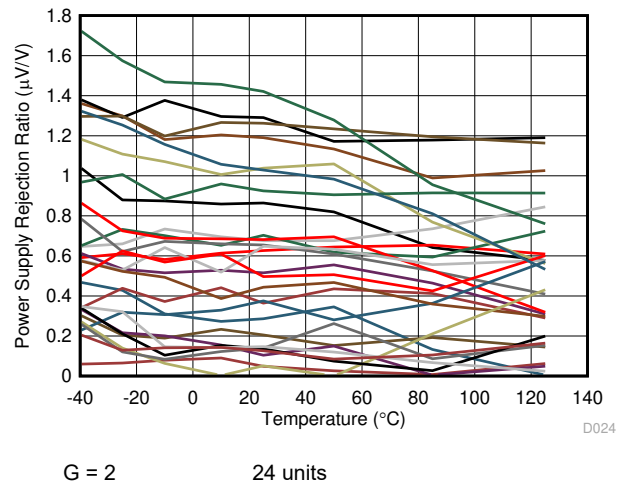

**Figure 7-24. PSRR vs Temperature**

### 7.7 Typical Characteristics (continued)

at  $T_A = 25^\circ\text{C}$ ,  $V_S = \pm 18\text{ V}$ ,  $V_{CM} = V_{OUT} = V_S / 2$ ,  $R_L = 10\text{ k}\Omega$ , REF pin connected to ground,  $G = 1/2$  (unless otherwise noted)

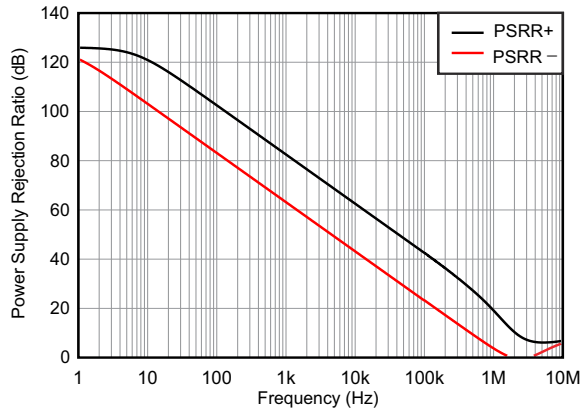

G = 1/2

Figure 7-25. PSRR vs Frequency (RTI)

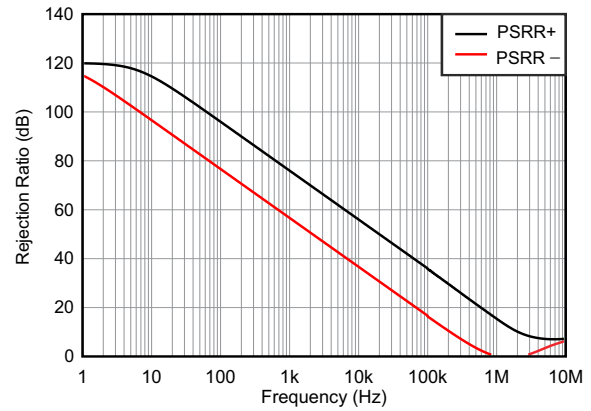

G = 2

Figure 7-26. PSRR vs Frequency (RTI)

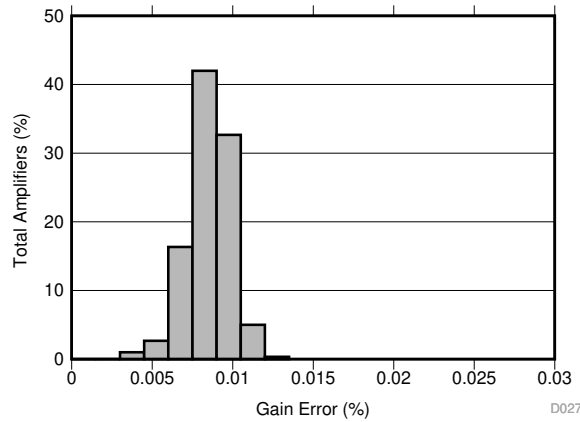

N = 470 Mean = 0.0085% Std. Dev. = 0.0014%

G = 1/2

Figure 7-27. Typical Distribution of Gain Error

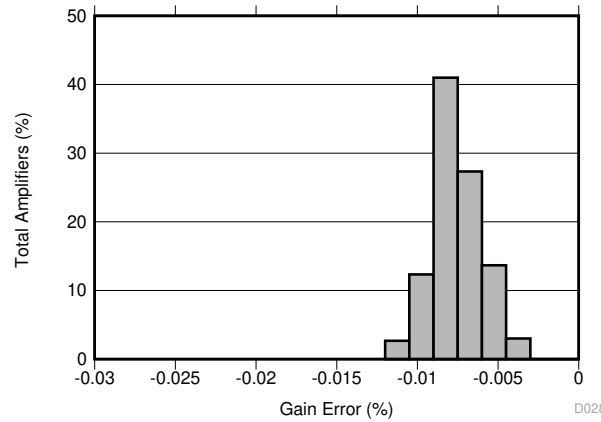

N = 470 Mean = -0.0076% Std. Dev. = 0.0015%

G = 2

Figure 7-28. Typical Distribution of Gain Error

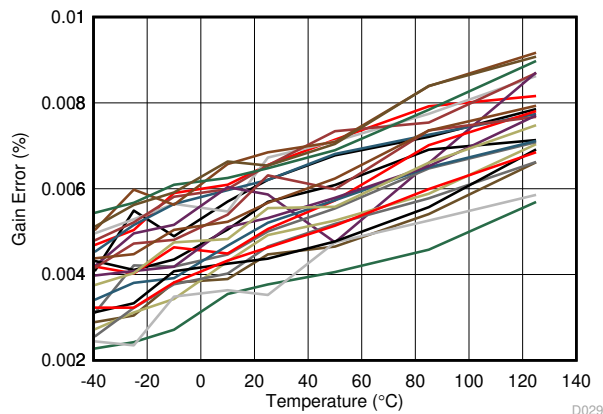

G = 1/2

30 units

Figure 7-29. Gain Error vs Temperature

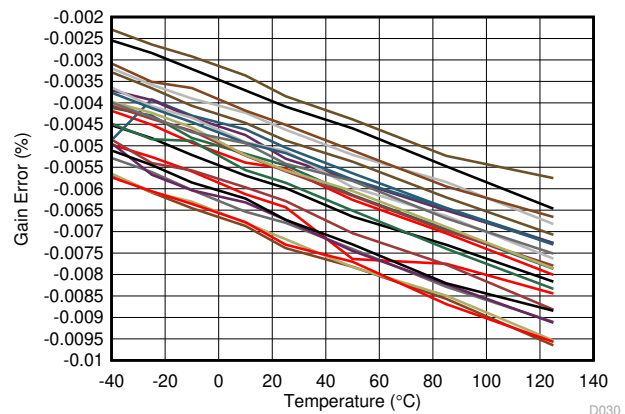

G = 2

30 units

Figure 7-30. Gain Error vs Temperature

### 7.7 Typical Characteristics (continued)

at  $T_A = 25^\circ\text{C}$ ,  $V_S = \pm 18\text{ V}$ ,  $V_{CM} = V_{OUT} = V_S / 2$ ,  $R_L = 10\text{ k}\Omega$ , REF pin connected to ground,  $G = 1/2$  (unless otherwise noted)

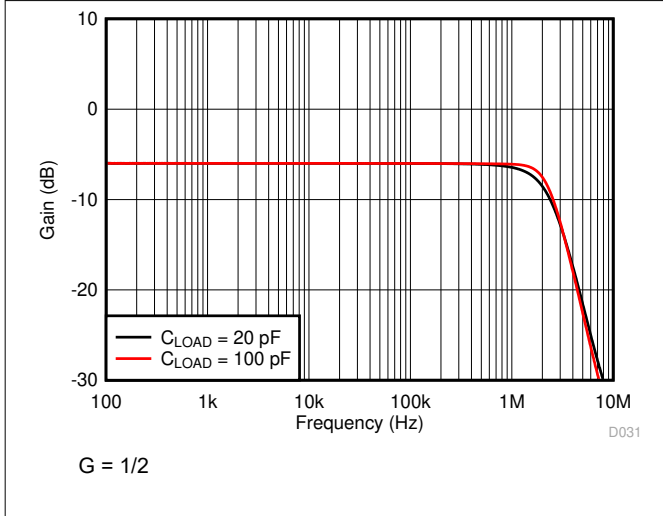

Figure 7-31. Closed-Loop Gain vs Frequency

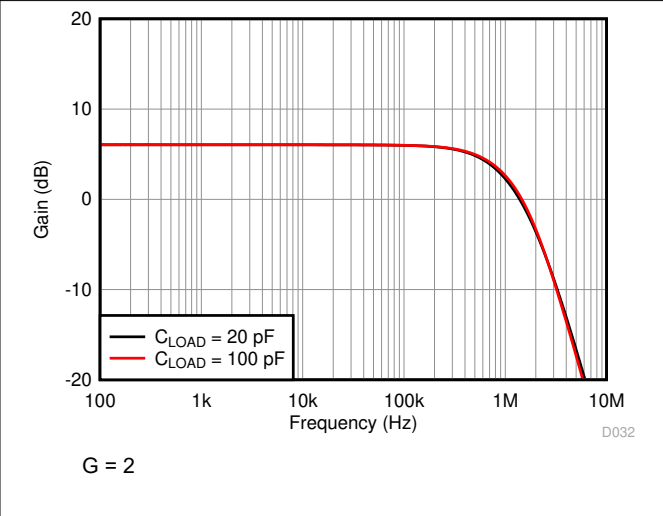

Figure 7-32. Closed-Loop Gain vs Frequency

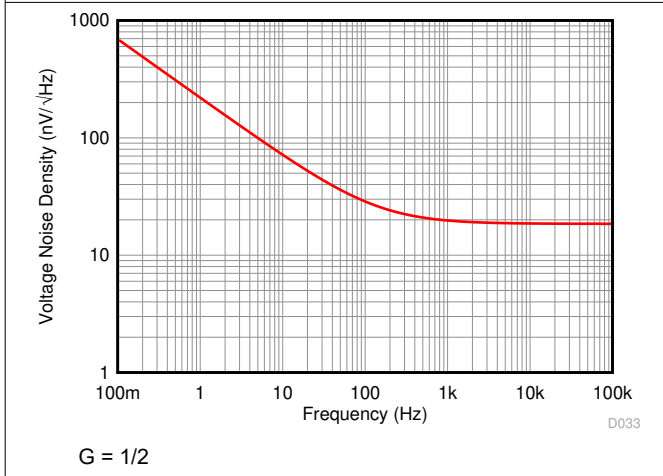

Figure 7-33. Voltage Noise Spectral Density vs Frequency (RTI)

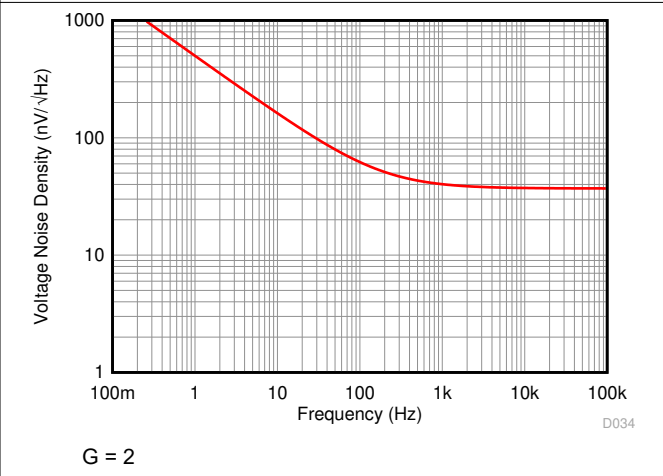

Figure 7-34. Voltage Noise Spectral Density vs Frequency (RTI)

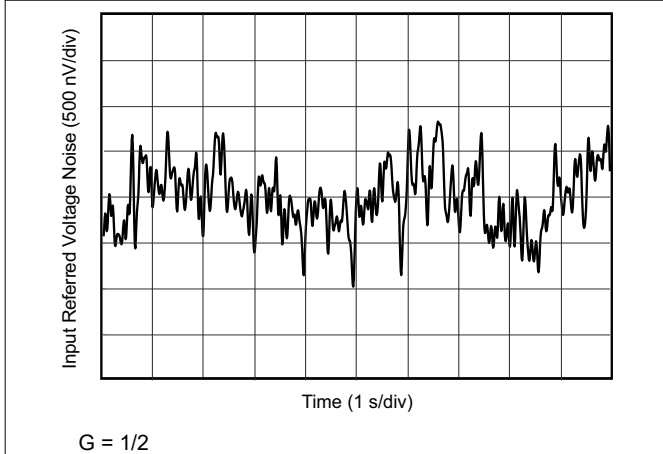

Figure 7-35. 0.1-Hz to 10-Hz RTI Voltage Noise

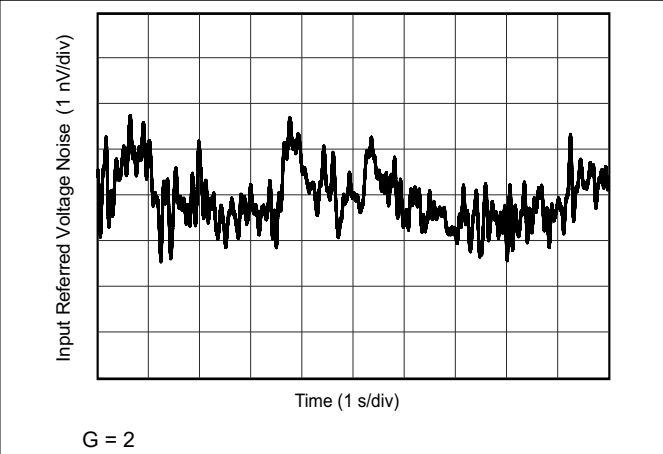
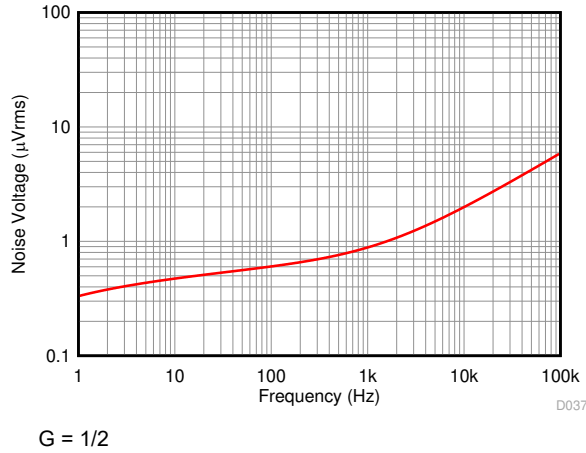

Figure 7-36. 0.1-Hz to 10-Hz RTI Voltage Noise

### 7.7 Typical Characteristics (continued)

at  $T_A = 25^\circ\text{C}$ ,  $V_S = \pm 18\text{ V}$ ,  $V_{CM} = V_{OUT} = V_S / 2$ ,  $R_L = 10\text{ k}\Omega$ , REF pin connected to ground,  $G = 1/2$  (unless otherwise noted)



**Figure 7-37. Integrated Output Voltage Noise vs Noise Bandwidth**

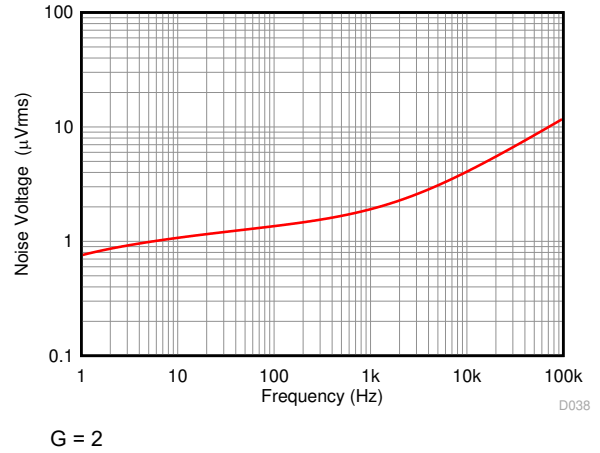

**Figure 7-38. Integrated Output Voltage Noise vs Noise Bandwidth**

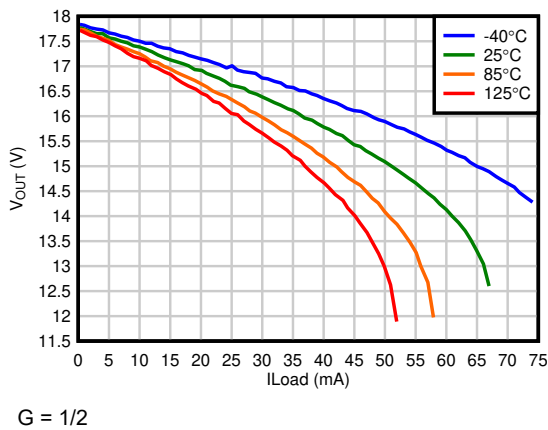

**Figure 7-39. Positive Output Voltage vs Output Current (Sourcing)**

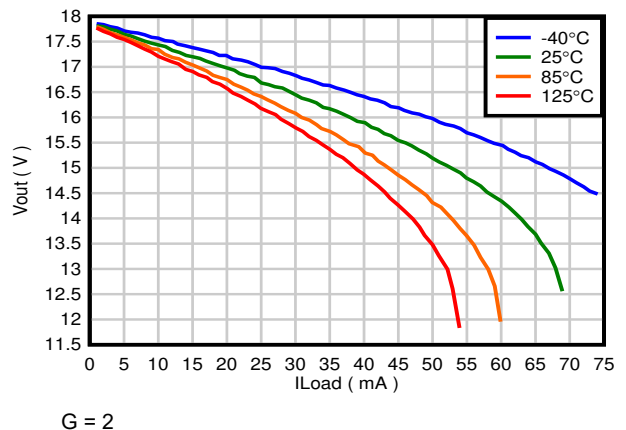

**Figure 7-40. Positive Output Voltage vs Output Current (Sourcing)**

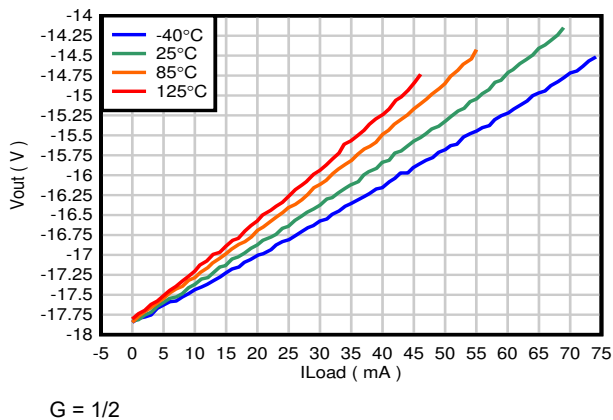

**Figure 7-41. Negative Output Voltage vs Output Current (Sinking)**

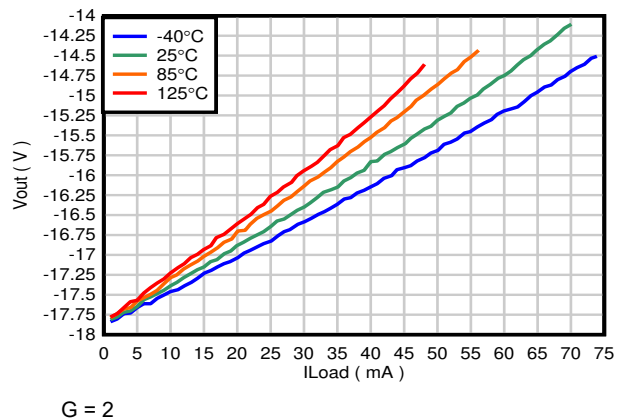

**Figure 7-42. Negative Output Voltage vs Output Current (Sinking)**

### 7.7 Typical Characteristics (continued)

at  $T_A = 25^\circ\text{C}$ ,  $V_S = \pm 18\text{ V}$ ,  $V_{CM} = V_{OUT} = V_S / 2$ ,  $R_L = 10\text{ k}\Omega$ , REF pin connected to ground,  $G = 1/2$  (unless otherwise noted)

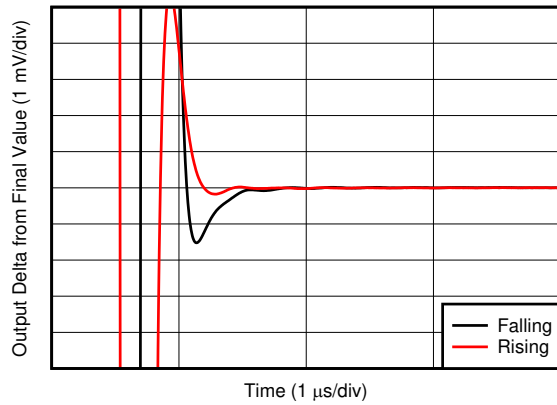

D043

$G = 1/2$

Figure 7-43. Settling Time

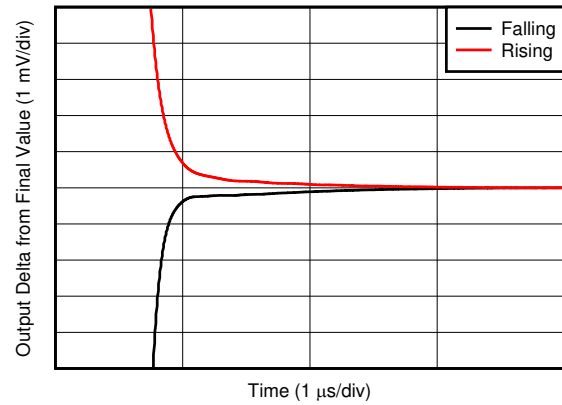

D044

$G = 2$

Figure 7-44. Settling Time

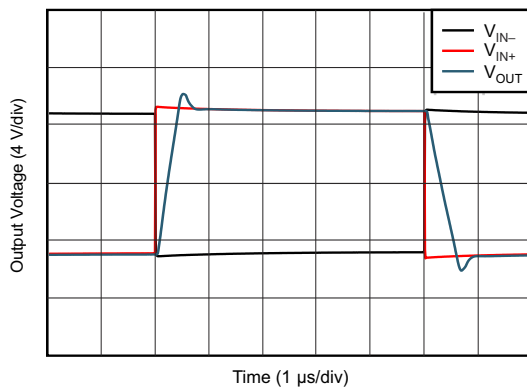

$G = 1/2$

Figure 7-45. Large-Signal Step Response

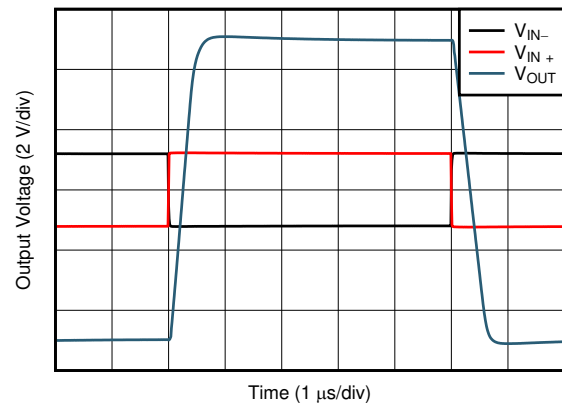

D046

$G = 2$

Figure 7-46. Large-Signal Step Response

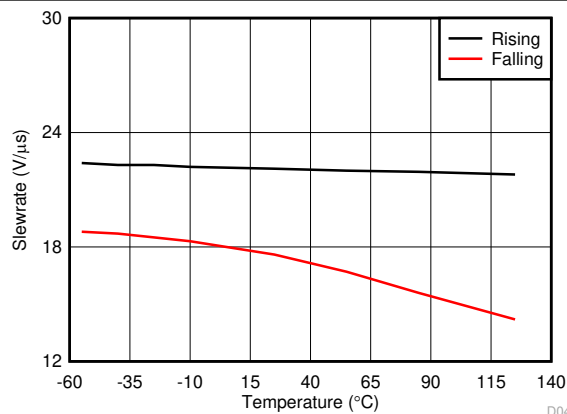

D047

Figure 7-47. Slew Rate Over Temperature

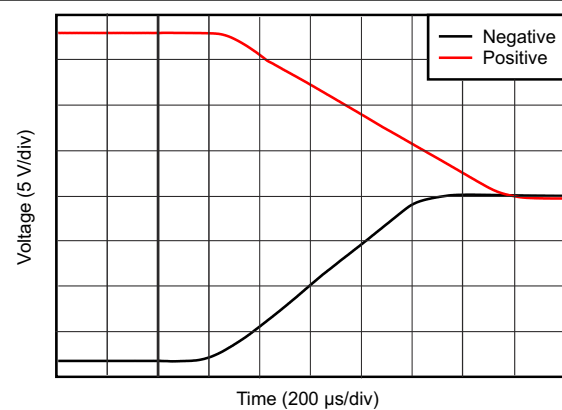

Figure 7-48. Overload Recovery (Normalized to 0 V)



## 7.7 Typical Characteristics (continued)

at  $T_A = 25^\circ\text{C}$ ,  $V_S = \pm 18\text{ V}$ ,  $V_{CM} = V_{OUT} = V_S / 2$ ,  $R_L = 10\text{ k}\Omega$ , REF pin connected to ground,  $G = 1/2$  (unless otherwise noted)

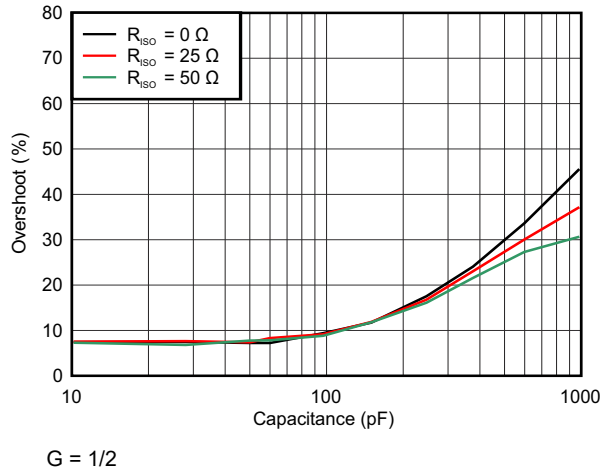

Figure 7-49. Small-Signal Overshoot vs Capacitive Load

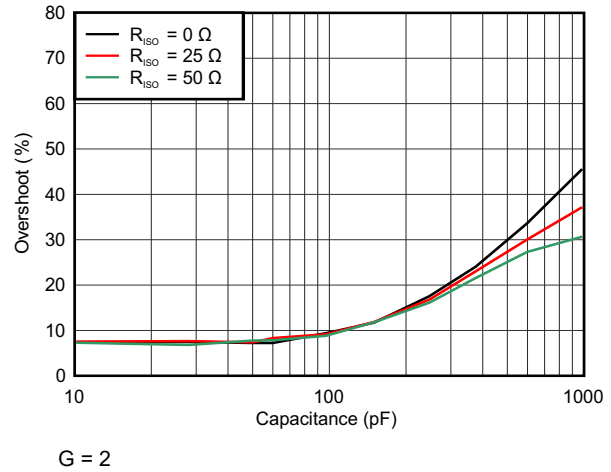

Figure 7-50. Small-Signal Overshoot vs Capacitive Load

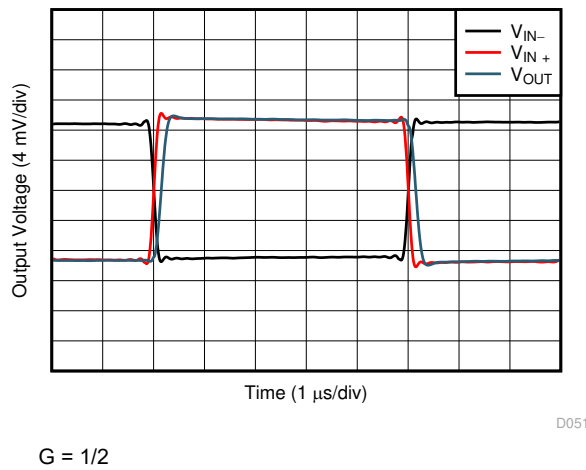

Figure 7-51. Small-Signal Step Response

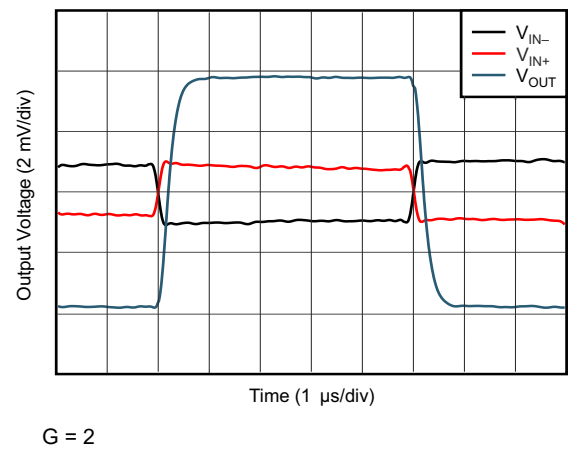

Figure 7-52. Small-Signal Step Response

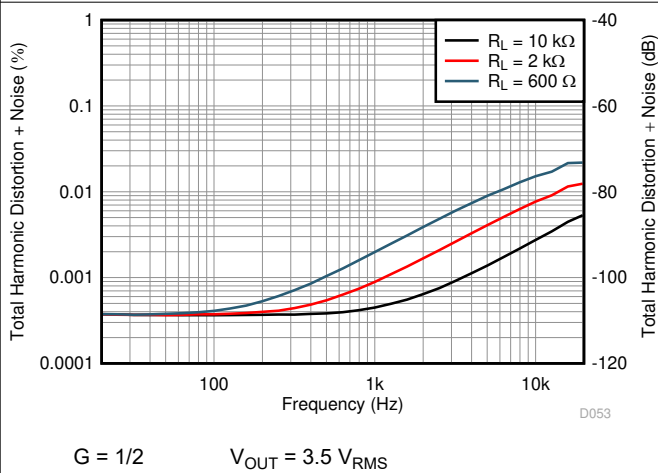

Figure 7-53. THD+N vs Frequency

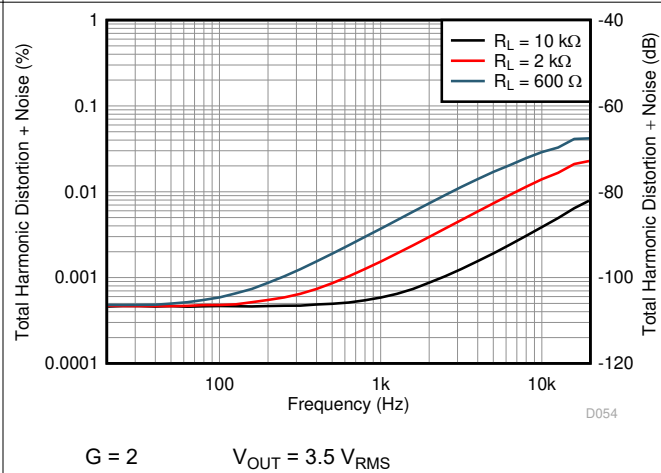

Figure 7-54. THD+N vs Frequency

### 7.7 Typical Characteristics (continued)

at  $T_A = 25^\circ\text{C}$ ,  $V_S = \pm 18\text{ V}$ ,  $V_{CM} = V_{OUT} = V_S / 2$ ,  $R_L = 10\text{ k}\Omega$ , REF pin connected to ground,  $G = 1/2$  (unless otherwise noted)

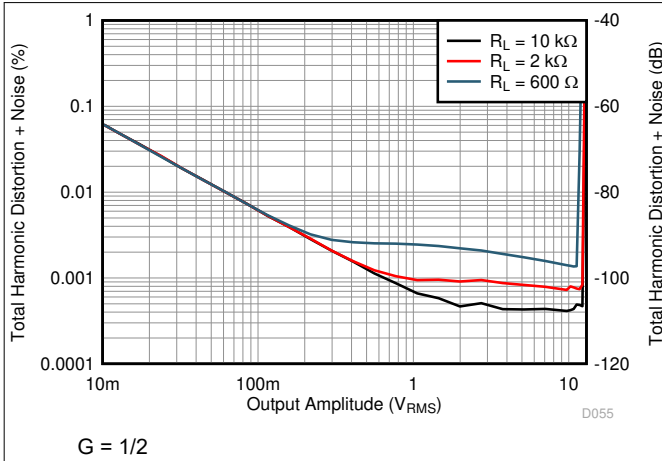

Figure 7-55. THD+N Ratio vs Output Amplitude

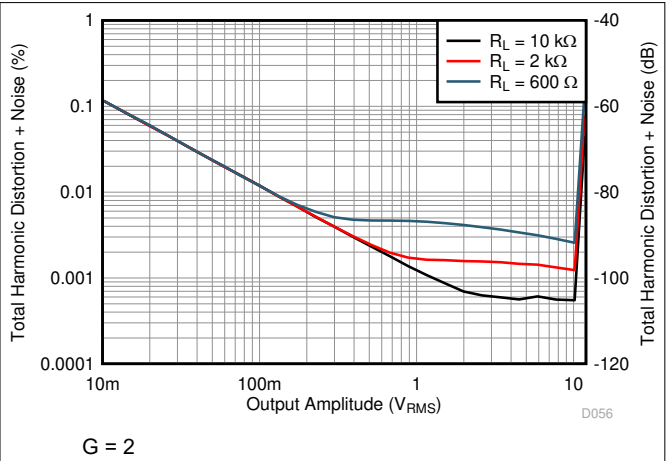

Figure 7-56. THD+N Ratio vs Output Amplitude

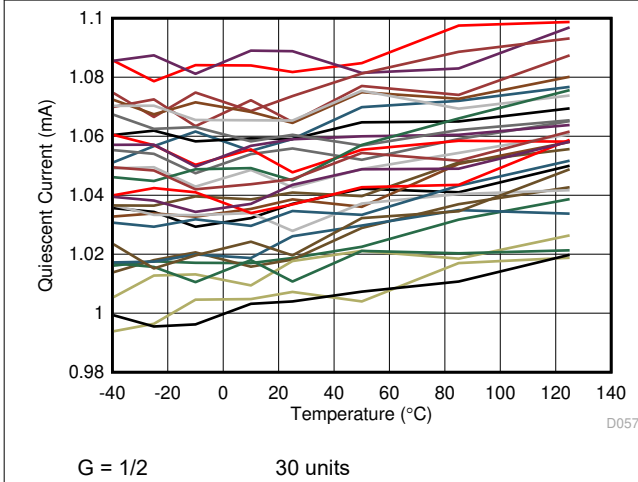

Figure 7-57. Supply Current vs Temperature

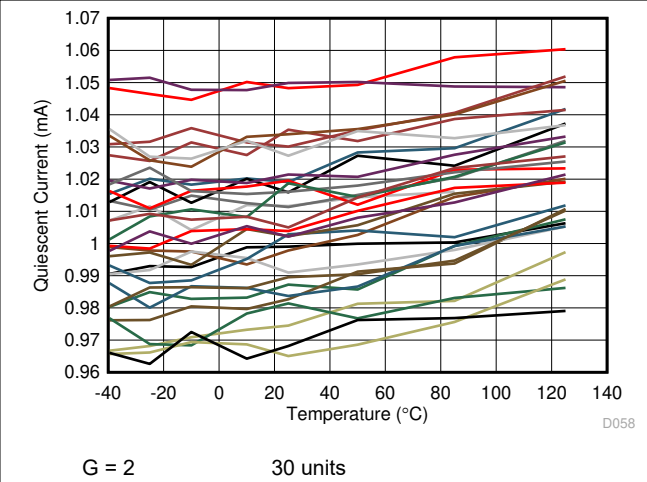

Figure 7-58. Supply Current vs Temperature

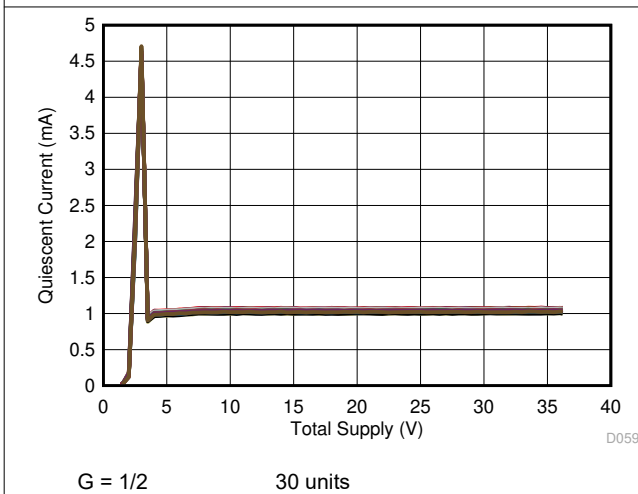

Figure 7-59. Supply Current vs Supply Voltage

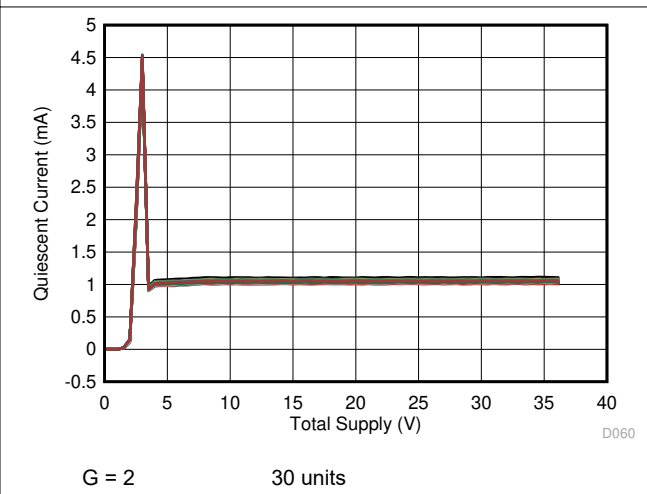

Figure 7-60. Supply Current vs Supply Voltage

### 7.7 Typical Characteristics (continued)

at  $T_A = 25^\circ\text{C}$ ,  $V_S = \pm 18\text{ V}$ ,  $V_{CM} = V_{OUT} = V_S / 2$ ,  $R_L = 10\text{ k}\Omega$ , REF pin connected to ground,  $G = 1/2$  (unless otherwise noted)

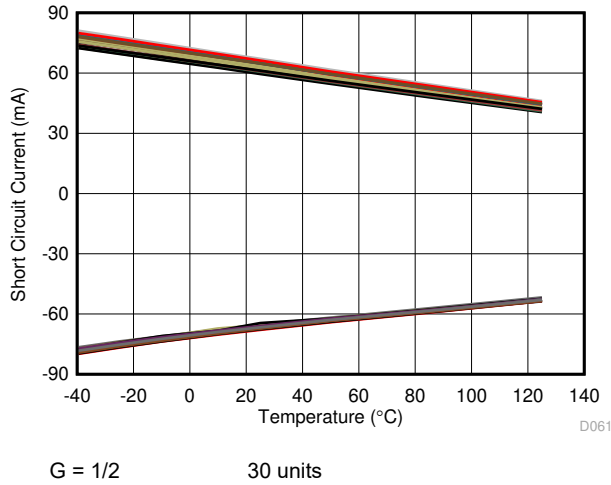

Figure 7-61. Short Circuit Current vs Temperature

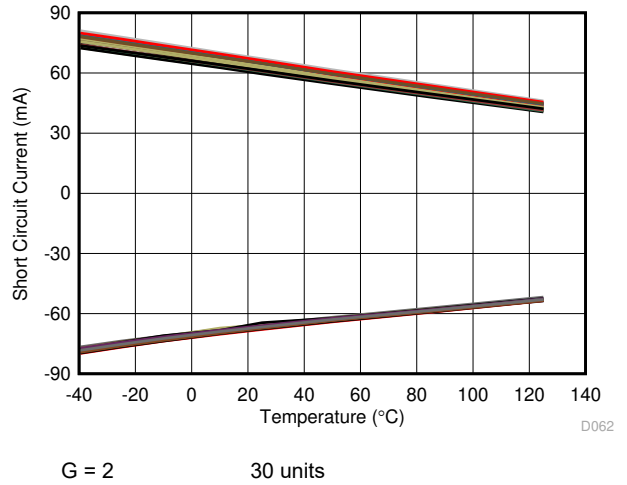

Figure 7-62. Short Circuit Current vs Temperature

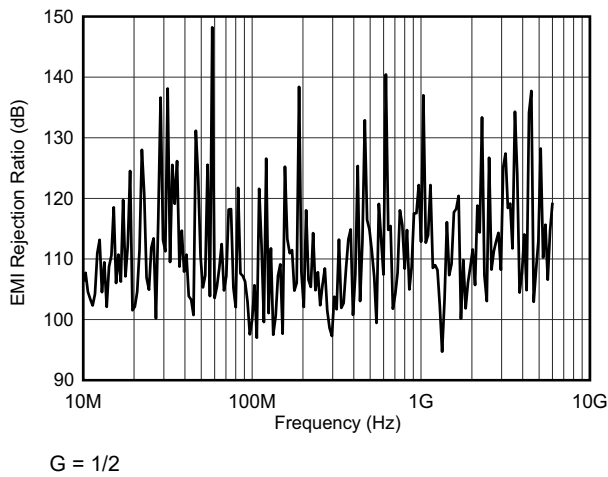

Figure 7-63. Differential-Mode EMI Rejection Ratio

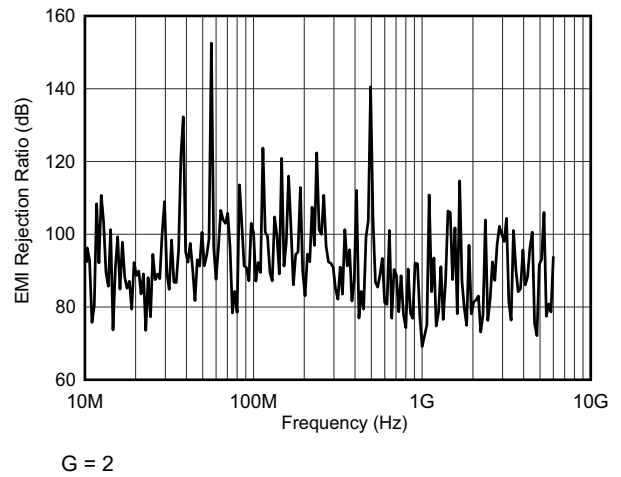

Figure 7-64. Differential-Mode EMI Rejection Ratio

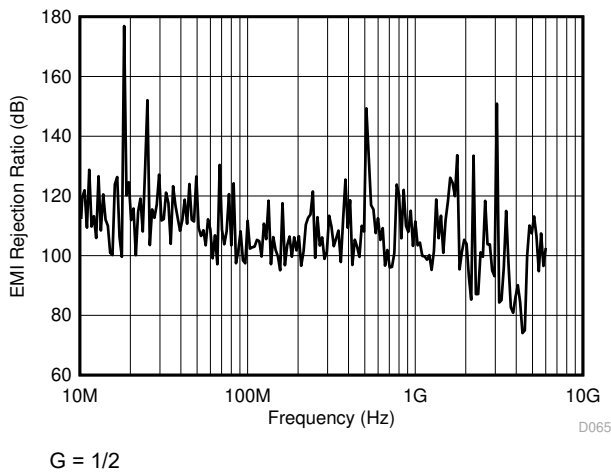

Figure 7-65. Common-Mode EMI Rejection Ratio

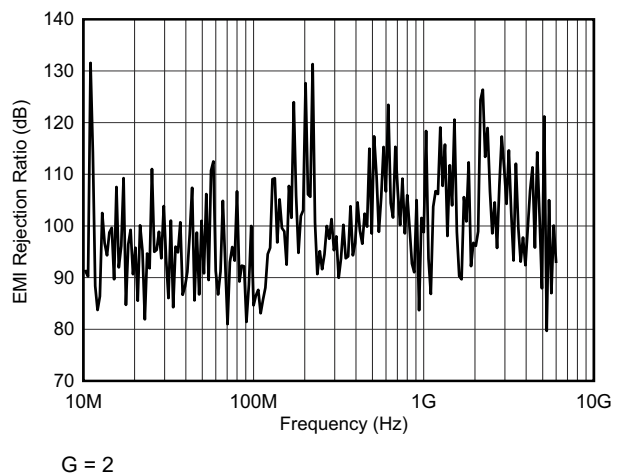

Figure 7-66. Common-Mode EMI Rejection Ratio

### 7.7 Typical Characteristics (continued)

at  $T_A = 25^\circ\text{C}$ ,  $V_S = \pm 18\text{ V}$ ,  $V_{CM} = V_{OUT} = V_S / 2$ ,  $R_L = 10\text{ k}\Omega$ , REF pin connected to ground,  $G = 1/2$  (unless otherwise noted)

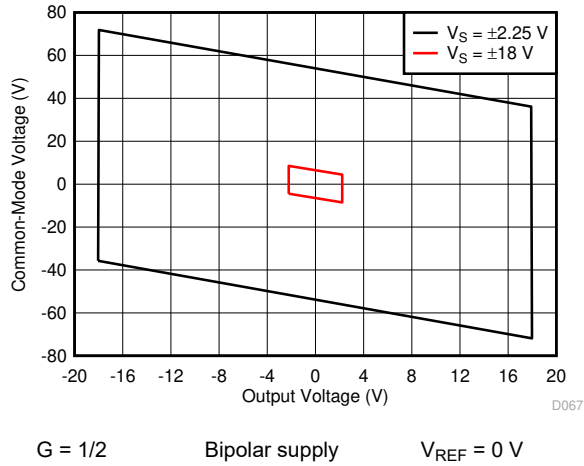

Figure 7-67. Input Common-Mode Voltage vs Output Voltage

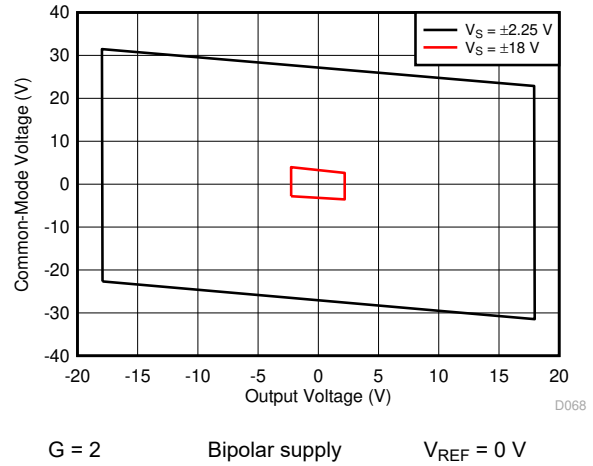

Figure 7-68. Input Common-Mode Voltage vs Output Voltage

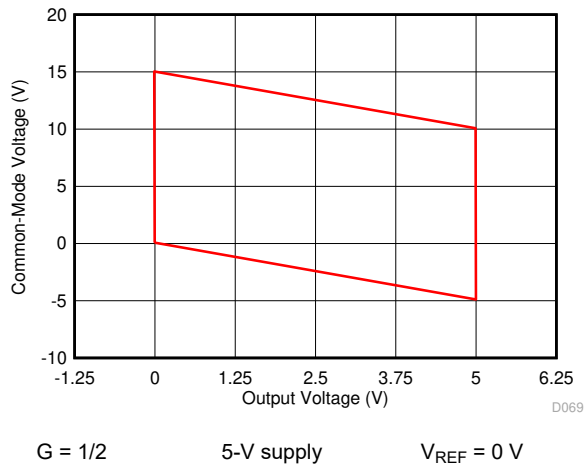

Figure 7-69. Input Common-Mode Voltage vs Output Voltage

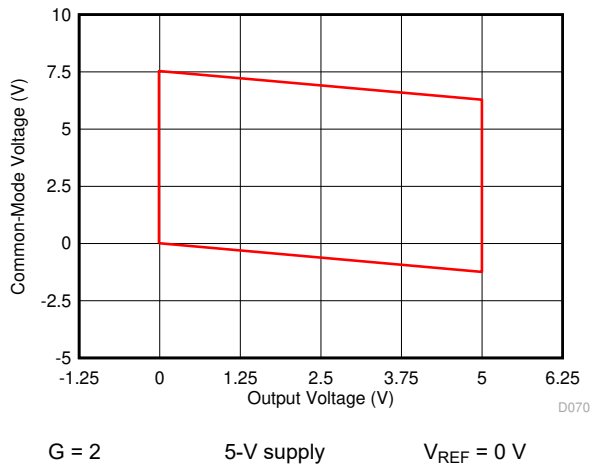

Figure 7-70. Input Common-Mode Voltage vs Output Voltage

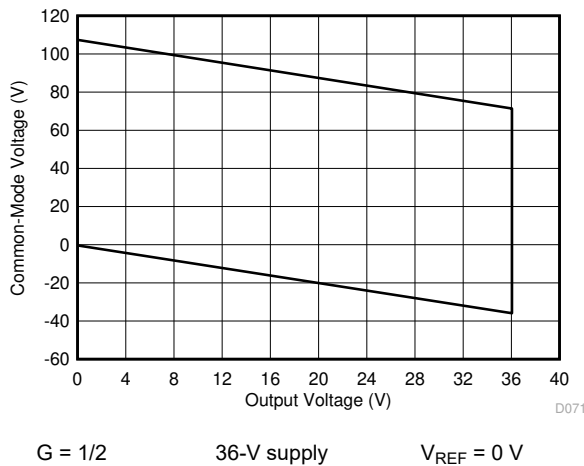

Figure 7-71. Input Common-Mode Voltage vs Output Voltage

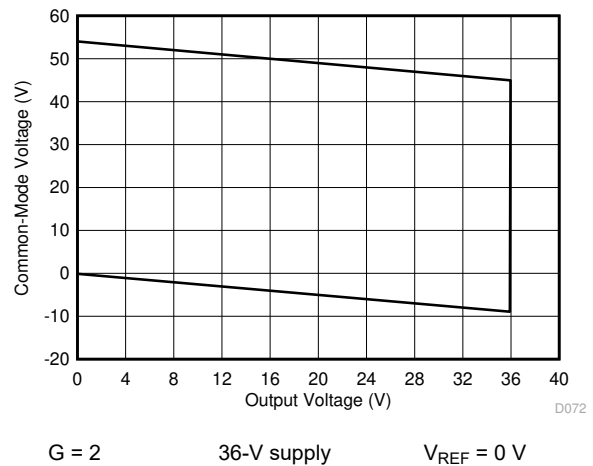
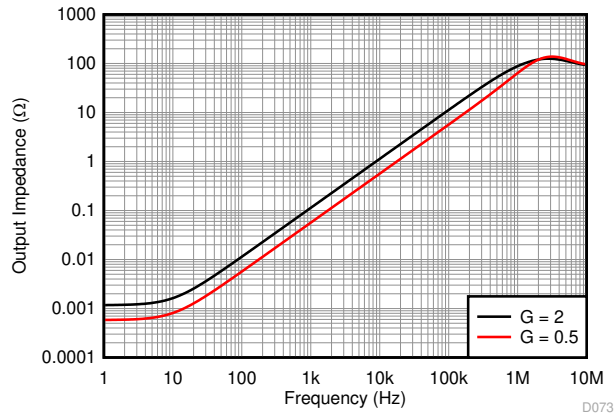

Figure 7-72. Input Common-Mode Voltage vs Output Voltage

### 7.7 Typical Characteristics (continued)

at  $T_A = 25^\circ\text{C}$ ,  $V_S = \pm 18\text{ V}$ ,  $V_{CM} = V_{OUT} = V_S / 2$ ,  $R_L = 10\text{ k}\Omega$ , REF pin connected to ground,  $G = 1/2$  (unless otherwise noted)



**Figure 7-73. Closed-Loop Output Impedance vs Frequency** D073

## 8 Detailed Description

### 8.1 Overview

The INA597 consists of a high-precision, e-trim™ operational amplifier and four trimmed resistors. These resistors can be connected to make a wide variety of amplifier configurations, including difference, noninverting, and inverting configurations. Using the on-chip resistors of the INA597 provides the designer with several advantages over a discrete design. The INA597 also includes internal compensation capacitors, as shown in [Section 8.2](#).

### 8.2 Functional Block Diagram

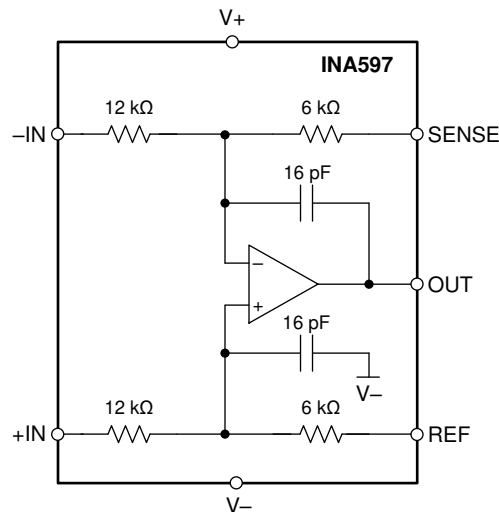

### 8.3 Feature Description

Much of the dc performance of op-amp circuits depends on the accuracy of the surrounding resistors. The resistors on the INA597 are laid out to be tightly matched. The resistors of each part are matched on-chip and tested for their matching accuracy. As a result of this trimming and testing, the INA597 provides high accuracy for specifications such as gain drift, common-mode rejection, and gain error.

### 8.4 Device Functional Modes

The INA597 measures voltages beyond the rails. For the  $G = \frac{1}{2}$  and  $G = 2$  difference amplifier configurations, see the input voltage range in [Section 7](#) for details. The INA597 can be configured in several ways; see [Figure 9-5](#) to [Figure 9-9](#). These configurations rely on the internal, matched resistors; therefore, all of these configurations have excellent gain accuracy and gain drift.

## 9 Application and Implementation

### Note

Information in the following applications sections is not part of the TI component specification, and TI does not warrant its accuracy or completeness. TI's customers are responsible for determining suitability of components for their purposes, as well as validating and testing their design implementation to confirm system functionality.

### 9.1 Application Information

Figure 9-1 shows the basic connections required for operation of the INA597. Connect power supply bypass capacitors close to the device pins.

The differential input signal is connected to pins 2 and 3, as shown. The source impedances connected to the inputs must be nearly equal to provide good common-mode rejection. An 8-Ω mismatch in source impedance degrades the common-mode rejection of a typical device to approximately 80 dB. Gain accuracy is also slightly affected. If the source has a known impedance mismatch, use an additional resistor in series with one input to preserve good common-mode rejection.

### 9.2 Typical Applications

#### 9.2.1 Basic Power-Supply and Signal Connections

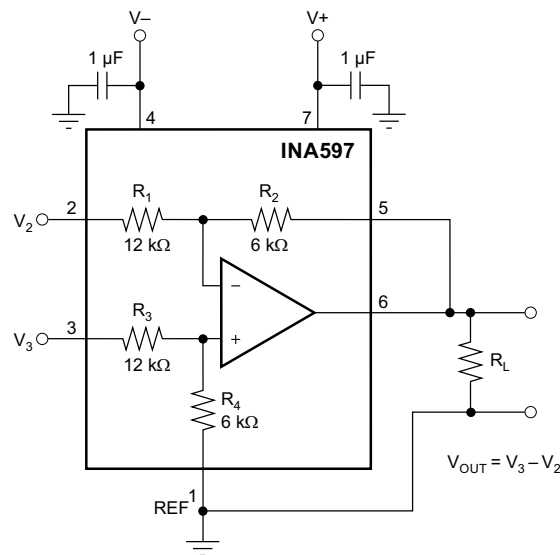

Figure 9-1. Basic Power-Supply and Signal Connections

##### 9.2.1.1 Design Requirements

For the application shown in Figure 9-1, the design requirements are:

- Gain of  $G = \frac{1}{2}$
- $V_{REF} = 0\text{ V}$

## 9.2.1.2 Detailed Design Procedure

### 9.2.1.2.1 Operating Voltage

The INA597 operates from single (4.5 V to 36 V) or dual ( $\pm 2.25$  V to  $\pm 18$  V) supplies with excellent performance. Specifications are production tested with +5-V and  $\pm 15$ -V supplies. Most behavior remains unchanged throughout the full operating voltage range. Parameters that vary significantly with operating voltage are shown in [Section 7.7](#). The internal op amp in the INA597 is a single-supply design. This design allows linear operation with the op amp common-mode voltage equal to, or slightly less than  $V^-$  (or single-supply ground). Although input voltages on pins 2 and 3 that are less than the negative supply voltage do not damage the device, operation in this region is not recommended. Transient conditions at the inverting input terminal less than the negative supply can cause a positive feedback condition that could lock the device output to the negative rail.

The INA597 accurately measures differential signals that are greater than the positive power supply. For example with  $G = \frac{1}{2}$ , the linear common-mode range extends to nearly three times the positive power supply voltage; see [Section 7.7](#), as well as [Section 9.2.1.2.3](#).

### 9.2.1.2.2 Offset Voltage Trim

The INA597 is production trimmed for low offset voltage and drift. Most applications require no external offset adjustment. [Figure 9-2](#) shows an optional circuit for trimming the output offset voltage. The output is referred to the output reference terminal (pin 1), which is normally grounded. A voltage applied to the REF pin is summed with the output signal. This configuration can be used to null offset voltage. To maintain good common-mode rejection, make sure the source impedance of a signal applied to the REF pin is less than  $8\ \Omega$ . For low impedance at the REF pin, the trim voltage can be buffered with an op amp, such as the [OPA177](#).

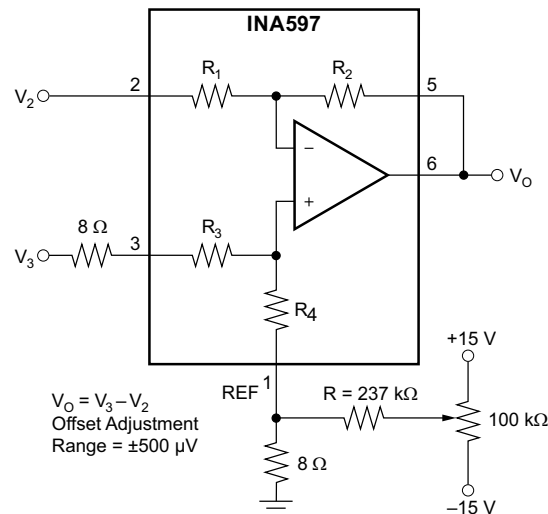

NOTE: For  $\pm 750\text{-}\mu\text{V}$  range,  $R = 158\ \text{k}\Omega$ .

**Figure 9-2. Offset Adjustment**



### 9.2.1.2.3 Input Voltage Range

The INA597 measures input voltages beyond the supply rails. The internal resistors divide down the voltage before the voltage reaches the internal op amp and provide protection to the op amp inputs. [Figure 9-3](#) shows an example of how the voltage division works in a difference-amplifier configuration. For the INA597 to measure correctly, the input voltages at the input nodes of the internal op amp must stay less than 0.1 V of the positive supply rail, and can exceed the negative supply rail by 0.1 V. See [Section 10](#) for more details.

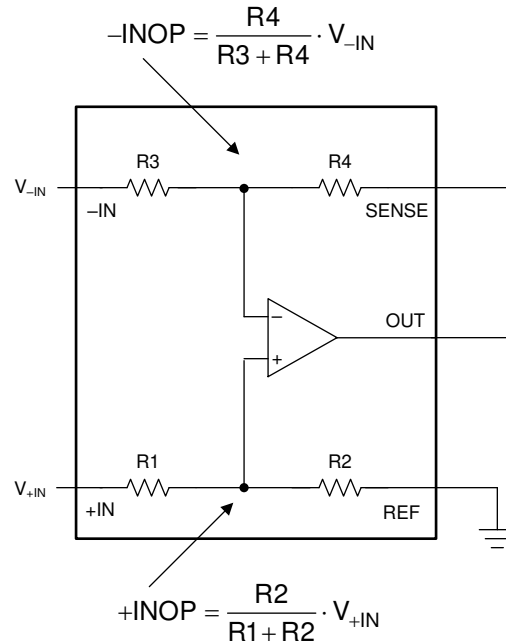

**Figure 9-3. Voltage Division in the Difference Amplifier Configuration**

The INA597 has integrated ESD diodes at the inputs that provide overvoltage protection. This feature simplifies system design by eliminating the need for additional external protection circuitry, and enables a more robust system. The voltages at any of the inputs of the parts in  $G = \frac{1}{2}$  configuration with  $\pm 18$  V supplies can safely range from  $+V_S - 54$  V up to  $-V_S + 54$  V. For example, on  $\pm 10$ -V supplies, the input voltages can go as high as  $\pm 30$  V.

### 9.2.1.2.4 Capacitive Load Drive Capability

The INA597 can drive large capacitive loads, even at low supplies. The device is stable with a 500-pF load; see [Section 7.7](#).

### 9.2.1.3 Application Curve

The interaction between the output stage of an operational amplifier (op amp) and capacitive loads can impact the stability of the circuit. Throughout the industry, op-amp output-stage requirements have changed greatly since their original creation. Classic output stages with the class-AB common-emitter bipolar junction transistor (BJT) have now been replaced with common-collector BJT and common-drain complementary metal-oxide semiconductor (CMOS) devices. Both of these technologies enable rail-to-rail output voltages for single-supply and battery-powered applications. A result of changing these output-stage structures is that the op-amp open-loop output impedance ( $Z_O$ ) changed from the largely resistive behavior of early BJT op amps to a frequency-dependent  $Z_O$  that features capacitive, resistive, and inductive portions. Proper understanding of  $Z_O$  over frequency—and also the resulting closed-loop output impedance over frequency—is crucial for the understanding of loop gain, bandwidth, and stability analysis. Figure 9-4 shows how the INA597 closed-loop output impedance varies over frequency.

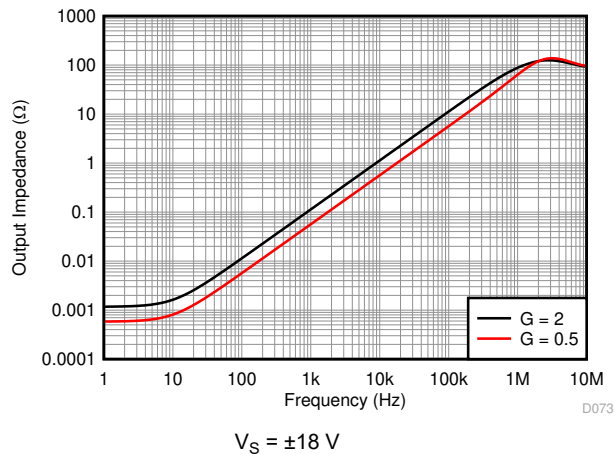

**Figure 9-4. Closed-Loop Output Impedance vs Frequency**

### 9.2.2 Precision Instrumentation Amplifier

The INA597 can be combined with op amps to form a complete instrumentation amplifier (IA) with specialized performance characteristics, as shown in [Figure 9-5](#).

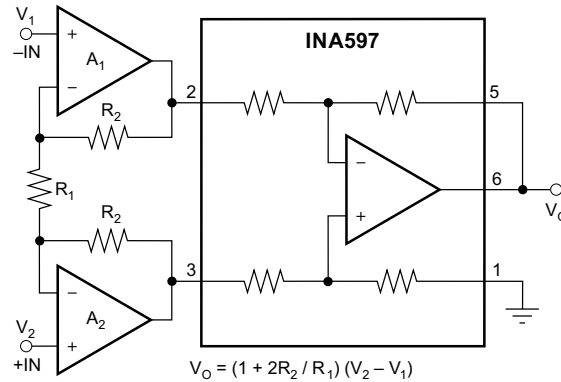

**Figure 9-5. Precision Instrumentation Amplifier**

### 9.2.3 Low Power, High-Output Current, Precision, Difference Amplifier

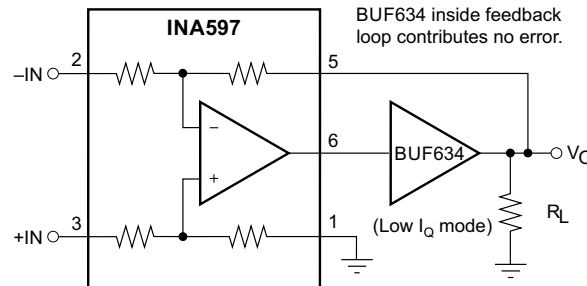

**Figure 9-6. Low Power, High-Output Current, Precision, Difference Amplifier**

### 9.2.4 Pseudoground Generator

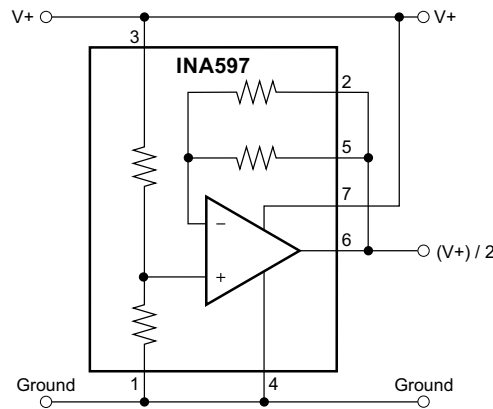

**Figure 9-7. Pseudoground Generator**

### 9.2.5 Differential Input Data Acquisition

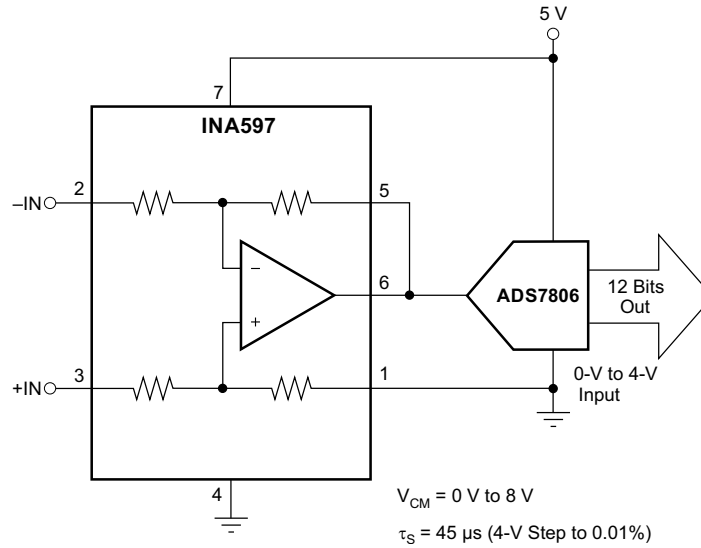

**Figure 9-8. Differential Input Data Acquisition**

### 9.2.6 Precision Voltage-to-Current Conversion

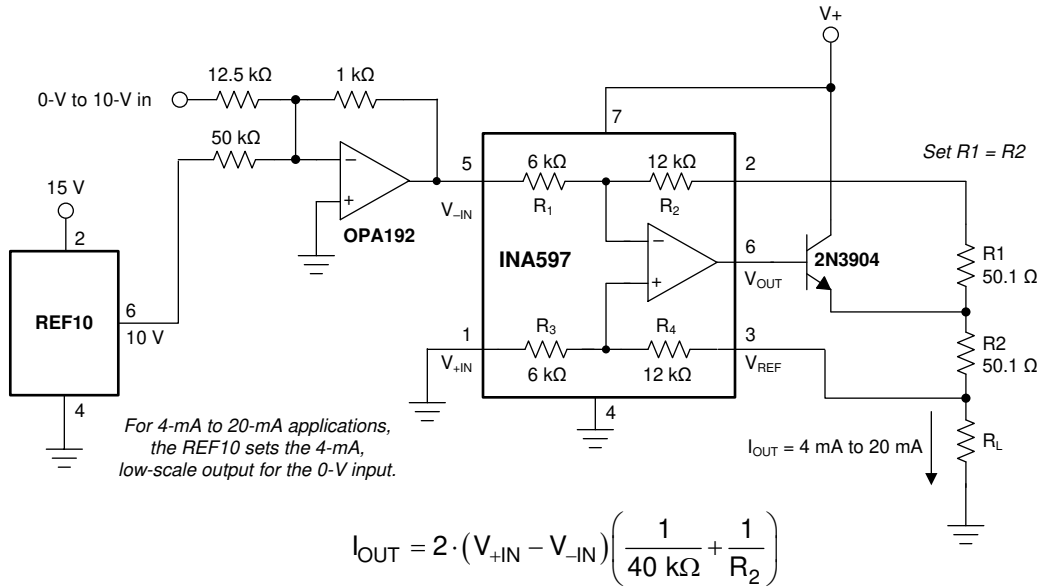

**Figure 9-9. Precision Voltage-to-Current Conversion**

### 9.2.7 Additional Applications

Texas Instruments offers many complete high-performance instrumentation amplifiers. See [Table 9-1](#) for some of the products with related performance.

**Table 9-1. Recommended Op Amp Products to Use With the INA597**

A1, A2	FEATURE	SIMILAR TI IA
<a href="#">OPA27</a>	Low noise	<a href="#">INA103</a>
<a href="#">OPA129</a>	Ultra-low bias current (fA)	<a href="#">INA116</a>
<a href="#">OPA177</a>	Low offset drift, low noise	<a href="#">INA114</a> , <a href="#">INA128</a>
<a href="#">OPA2130</a>	Low power, FET-input (pA)	<a href="#">INA111</a>
<a href="#">OPA2234</a>	Single supply, precision, low power	<a href="#">INA122</a> , <a href="#">INA118</a>
<a href="#">OPA2237</a>	Single supply, low power, 8-pin MSOP	<a href="#">INA122</a> , <a href="#">INA126</a>

The difference amplifier is a highly versatile building block that is useful in a wide variety of applications. See the [INA105 data sheet](#) for additional applications ideas, including:

- Current receiver with compliance to rails
- Precision unity-gain inverting amplifier
- $\pm 10$ -V precision voltage reference
- $\pm 5$ -V precision voltage reference
- Precision unity-gain buffer
- Precision average value amplifier
- Precision  $G = 2$  amplifier
- Precision summing amplifier
- Precision  $G = 1/2$  amplifier
- Precision bipolar offsetting
- Precision summing amplifier with gain
- Instrumentation amplifier guard drive generator
- Precision summing instrumentation amplifier
- Precision absolute value buffer
- Precision voltage-to-current converter with differential inputs
- Differential input voltage-to-current converter for low IOUT
- Isolating current source
- Differential output difference amplifier
- Isolating current source with buffering amplifier for greater accuracy
- Window comparator with window span and window center inputs
- Precision voltage-controlled current source with buffered differential inputs and gain
- Digitally controlled gain of  $\pm 1$  amplifier

## 10 Power Supply Recommendations

The nominal performance of the INA597 is specified with a supply voltage of  $\pm 15$  V and midsupply reference voltage. The device operates using power supplies from  $\pm 2.25$  V (4.5 V) to  $\pm 18$  V (36 V) and non-midsupply reference voltages with excellent performance. Parameters that can vary significantly with operating voltage and reference voltage are shown in [Section 7.7](#).

## 11 Layout

### 11.1 Layout Guidelines

Attention to good layout practices is always recommended. For best operational performance of the device, use good PCB layout practices, including:

- Take care to make sure that both input paths are well-matched for source impedance and capacitance to avoid converting common-mode signals into differential signals.
- Noise propagates into analog circuitry through the power pins of the circuit as a whole and of the device. Bypass capacitors reduce the coupled noise by providing low-impedance power sources local to the analog circuitry.
  - Connect low-ESR, 0.1- $\mu$ F ceramic bypass capacitors between each supply pin and ground, placed as close to the device as possible. A single bypass capacitor from V+ to ground is applicable for single-supply applications.
- To reduce parasitic coupling, run the input traces as far away from the supply or output traces as possible. If these traces cannot be kept separate, crossing the sensitive trace perpendicular is much better than in parallel with the noisy trace.
- Place the external components as close to the device as possible.
- Keep the traces as short as possible.

## 11.2 Layout Example

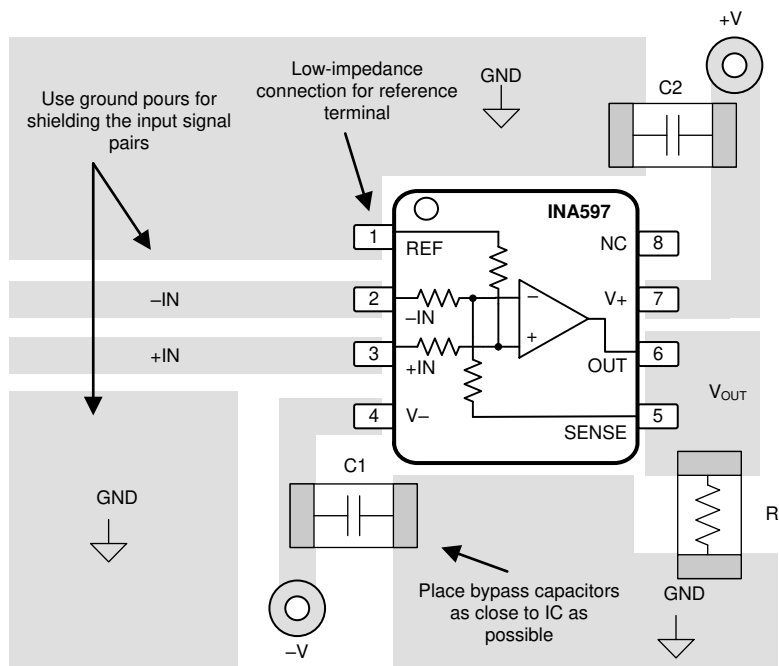
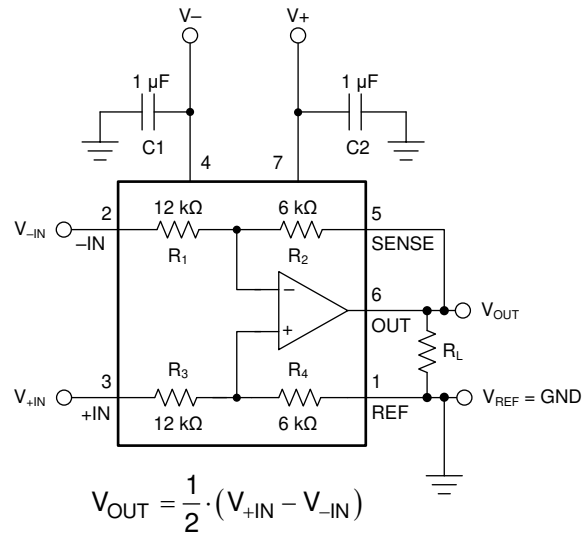

**Figure 11-1. Example Schematic and Associated PCB Layout for SOIC and VSSOP Packages**

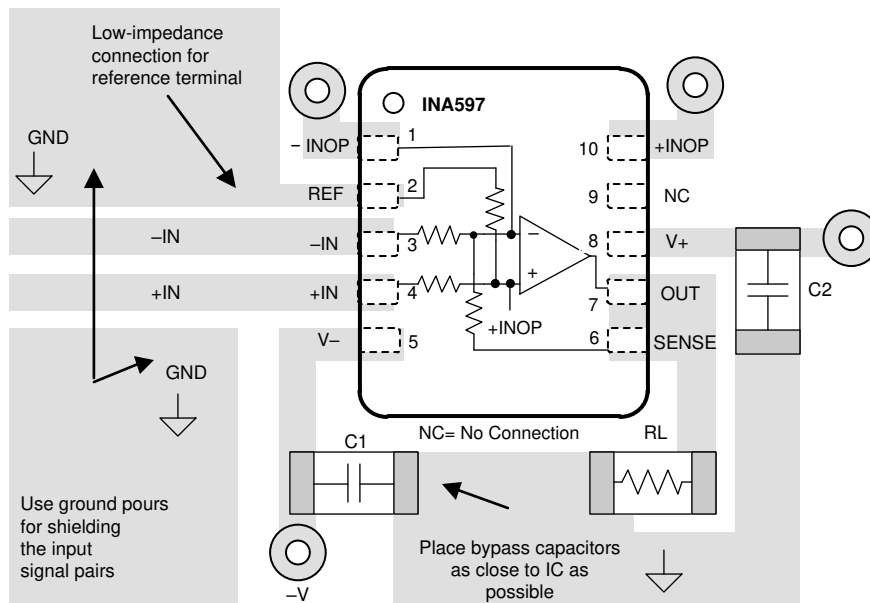
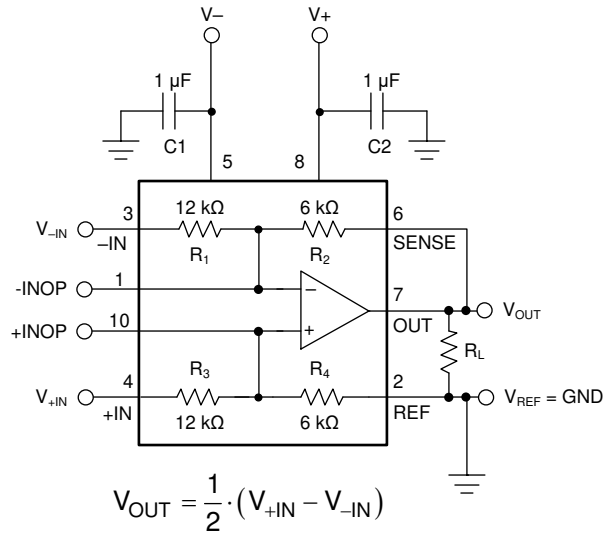

**Figure 11-2. Example Schematic and Associated PCB Layout with VSON Package**



## 12 Device and Documentation Support

### 12.1 Documentation Support

#### 12.1.1 Related Documentation

For related documentation see the following:

- Texas Instruments, [Universal Difference Amplifier Evaluation Module user's guide](#)
- Texas Instruments, [Precision Signal-Conditioning Solutions for Motor-Control Position Feedback technical brief](#)

#### 12.2 Receiving Notification of Documentation Updates

To receive notification of documentation updates, navigate to the device product folder on [ti.com](http://ti.com). Click on *Subscribe to updates* to register and receive a weekly digest of any product information that has changed. For change details, review the revision history included in any revised document.

#### 12.3 Support Resources

[TI E2E™ support forums](#) are an engineer's go-to source for fast, verified answers and design help — straight from the experts. Search existing answers or ask your own question to get the quick design help you need.

Linked content is provided "AS IS" by the respective contributors. They do not constitute TI specifications and do not necessarily reflect TI's views; see TI's [Terms of Use](#).

#### 12.4 Trademarks

e-trim™ and TI E2E™ are trademarks of Texas Instruments.  
All trademarks are the property of their respective owners.

#### 12.5 Electrostatic Discharge Caution



This integrated circuit can be damaged by ESD. Texas Instruments recommends that all integrated circuits be handled with appropriate precautions. Failure to observe proper handling and installation procedures can cause damage.

ESD damage can range from subtle performance degradation to complete device failure. Precision integrated circuits may be more susceptible to damage because very small parametric changes could cause the device not to meet its published specifications.

#### 12.6 Glossary

[TI Glossary](#) This glossary lists and explains terms, acronyms, and definitions.

## 13 Mechanical, Packaging, and Orderable Information

The following pages include mechanical, packaging, and orderable information. This information is the most current data available for the designated devices. This data is subject to change without notice and revision of this document. For browser-based versions of this data sheet, refer to the left-hand navigation.

**PACKAGING INFORMATION**

Orderable Device	Status (1)	Package Type	Package Drawing	Pins	Package Qty	Eco Plan (2)	Lead finish/ Ball material (6)	MSL Peak Temp (3)	Op Temp (°C)	Device Marking (4/5)	Samples
INA597IDGKR	ACTIVE	VSSOP	DGK	8	2500	RoHS & Green	NIPDAUAG   SN	Level-2-260C-1 YEAR	-40 to 125	1WT6	<a href="#">Samples</a>
INA597IDGKT	ACTIVE	VSSOP	DGK	8	250	RoHS & Green	NIPDAUAG   SN	Level-2-260C-1 YEAR	-40 to 125	1WT6	<a href="#">Samples</a>
INA597IDR	ACTIVE	SOIC	D	8	3000	RoHS & Green	NIPDAU	Level-2-260C-1 YEAR	-40 to 125	INA597	<a href="#">Samples</a>
INA597IDRCR	ACTIVE	VSON	DRC	10	3000	RoHS & Green	NIPDAU	Level-1-260C-UNLIM	-40 to 125	IN597	<a href="#">Samples</a>
INA597IDRCT	ACTIVE	VSON	DRC	10	250	RoHS & Green	NIPDAU	Level-1-260C-UNLIM	-40 to 125	IN597	<a href="#">Samples</a>
INA597IDT	ACTIVE	SOIC	D	8	250	RoHS & Green	NIPDAU	Level-2-260C-1 YEAR	-40 to 125	INA597	<a href="#">Samples</a>

(1) The marketing status values are defined as follows:

**ACTIVE:** Product device recommended for new designs.

**LIFEBUY:** TI has announced that the device will be discontinued, and a lifetime-buy period is in effect.

**NRND:** Not recommended for new designs. Device is in production to support existing customers, but TI does not recommend using this part in a new design.

**PREVIEW:** Device has been announced but is not in production. Samples may or may not be available.

**OBSELETE:** TI has discontinued the production of the device.

(2) **RoHS:** TI defines "RoHS" to mean semiconductor products that are compliant with the current EU RoHS requirements for all 10 RoHS substances, including the requirement that RoHS substance do not exceed 0.1% by weight in homogeneous materials. Where designed to be soldered at high temperatures, "RoHS" products are suitable for use in specified lead-free processes. TI may reference these types of products as "Pb-Free".

**RoHS Exempt:** TI defines "RoHS Exempt" to mean products that contain lead but are compliant with EU RoHS pursuant to a specific EU RoHS exemption.

**Green:** TI defines "Green" to mean the content of Chlorine (Cl) and Bromine (Br) based flame retardants meet JS709B low halogen requirements of <=1000ppm threshold. Antimony trioxide based flame retardants must also meet the <=1000ppm threshold requirement.

(3) MSL, Peak Temp. - The Moisture Sensitivity Level rating according to the JEDEC industry standard classifications, and peak solder temperature.

(4) There may be additional marking, which relates to the logo, the lot trace code information, or the environmental category on the device.

(5) Multiple Device Markings will be inside parentheses. Only one Device Marking contained in parentheses and separated by a "-" will appear on a device. If a line is indented then it is a continuation of the previous line and the two combined represent the entire Device Marking for that device.

(6) Lead finish/Ball material - Orderable Devices may have multiple material finish options. Finish options are separated by a vertical ruled line. Lead finish/Ball material values may wrap to two lines if the finish value exceeds the maximum column width.

**Important Information and Disclaimer:** The information provided on this page represents TI's knowledge and belief as of the date that it is provided. TI bases its knowledge and belief on information provided by third parties, and makes no representation or warranty as to the accuracy of such information. Efforts are underway to better integrate information from third parties. TI has taken and continues to take reasonable steps to provide representative and accurate information but may not have conducted destructive testing or chemical analysis on incoming materials and chemicals. TI and TI suppliers consider certain information to be proprietary, and thus CAS numbers and other limited information may not be available for release.

In no event shall TI's liability arising out of such information exceed the total purchase price of the TI part(s) at issue in this document sold by TI to Customer on an annual basis.

**TAPE AND REEL INFORMATION**

**QUADRANT ASSIGNMENTS FOR PIN 1 ORIENTATION IN TAPE**

\*All dimensions are nominal

Device	Package Type	Package Drawing	Pins	SPQ	Reel Diameter (mm)	Reel Width W1 (mm)	A0 (mm)	B0 (mm)	K0 (mm)	P1 (mm)	W (mm)	Pin1 Quadrant
INA597IDGKR	VSSOP	DGK	8	2500	330.0	12.4	5.3	3.4	1.4	8.0	12.0	Q1
INA597IDGKT	VSSOP	DGK	8	250	330.0	12.4	5.3	3.4	1.4	8.0	12.0	Q1
INA597IDR	SOIC	D	8	3000	330.0	12.4	6.4	5.2	2.1	8.0	12.0	Q1
INA597IDRCR	VSON	DRC	10	3000	330.0	12.4	3.3	3.3	1.1	8.0	12.0	Q2
INA597IDRCT	VSON	DRC	10	250	180.0	12.4	3.3	3.3	1.1	8.0	12.0	Q2
INA597IDT	SOIC	D	8	250	180.0	12.4	6.4	5.2	2.1	8.0	12.0	Q1

**TAPE AND REEL BOX DIMENSIONS**

\*All dimensions are nominal

Device	Package Type	Package Drawing	Pins	SPQ	Length (mm)	Width (mm)	Height (mm)
INA597IDGKR	VSSOP	DGK	8	2500	366.0	364.0	50.0
INA597IDGKT	VSSOP	DGK	8	250	366.0	364.0	50.0
INA597IDR	SOIC	D	8	3000	356.0	356.0	35.0
INA597IDRCR	VSON	DRC	10	3000	367.0	367.0	35.0
INA597IDRCT	VSON	DRC	10	250	210.0	185.0	35.0
INA597IDT	SOIC	D	8	250	210.0	185.0	35.0



D0008A

# PACKAGE OUTLINE

SOIC - 1.75 mm max height

SMALL OUTLINE INTEGRATED CIRCUIT



## NOTES:

1. Linear dimensions are in inches [millimeters]. Dimensions in parenthesis are for reference only. Controlling dimensions are in inches. Dimensioning and tolerancing per ASME Y14.5M.
2. This drawing is subject to change without notice.
3. This dimension does not include mold flash, protrusions, or gate burrs. Mold flash, protrusions, or gate burrs shall not exceed  $.006$  [0.15] per side.
4. This dimension does not include interlead flash.
5. Reference JEDEC registration MS-012, variation AA.

# EXAMPLE BOARD LAYOUT

D0008A

SOIC - 1.75 mm max height

SMALL OUTLINE INTEGRATED CIRCUIT



LAND PATTERN EXAMPLE  
EXPOSED METAL SHOWN  
SCALE:8X



SOLDER MASK DETAILS

4214825/C 02/2019

NOTES: (continued)

6. Publication IPC-7351 may have alternate designs.

7. Solder mask tolerances between and around signal pads can vary based on board fabrication site.

# EXAMPLE STENCIL DESIGN

D0008A

SOIC - 1.75 mm max height

SMALL OUTLINE INTEGRATED CIRCUIT



SOLDER PASTE EXAMPLE  
BASED ON .005 INCH [0.125 MM] THICK STENCIL  
SCALE:8X

4214825/C 02/2019

NOTES: (continued)

8. Laser cutting apertures with trapezoidal walls and rounded corners may offer better paste release. IPC-7525 may have alternate design recommendations.
9. Board assembly site may have different recommendations for stencil design.



DGK (S-PDSO-G8)

PLASTIC SMALL-OUTLINE PACKAGE



4073329/E 05/06

- NOTES:
- A. All linear dimensions are in millimeters.
  - B. This drawing is subject to change without notice.
  - C. Body length does not include mold flash, protrusions, or gate burrs. Mold flash, protrusions, or gate burrs shall not exceed 0.15 per end.
  - D. Body width does not include interlead flash. Interlead flash shall not exceed 0.50 per side.
  - E. Falls within JEDEC MO-187 variation AA, except interlead flash.



- NOTES:
- A. All linear dimensions are in millimeters.
  - B. This drawing is subject to change without notice.
  - C. Publication IPC-7351 is recommended for alternate designs.
  - D. Laser cutting apertures with trapezoidal walls and also rounding corners will offer better paste release. Customers should contact their board assembly site for stencil design recommendations. Refer to IPC-7525 for other stencil recommendations.
  - E. Customers should contact their board fabrication site for solder mask tolerances between and around signal pads.

## GENERIC PACKAGE VIEW

**DRC 10**

**VSON - 1 mm max height**

3 x 3, 0.5 mm pitch

PLASTIC SMALL OUTLINE - NO LEAD

This image is a representation of the package family, actual package may vary.  
Refer to the product data sheet for package details.



4226193/A



# EXAMPLE BOARD LAYOUT

DRC0010J

VSON - 1 mm max height

PLASTIC SMALL OUTLINE - NO LEAD



LAND PATTERN EXAMPLE  
EXPOSED METAL SHOWN  
SCALE:20X



SOLDER MASK DETAILS

4218878/B 07/2018

NOTES: (continued)

4. This package is designed to be soldered to a thermal pad on the board. For more information, see Texas Instruments literature number SLUA271 ([www.ti.com/lit/sluea271](http://www.ti.com/lit/sluea271)).
5. Vias are optional depending on application, refer to device data sheet. If any vias are implemented, refer to their locations shown on this view. It is recommended that vias under paste be filled, plugged or tented.

# EXAMPLE STENCIL DESIGN

DRC0010J

VSON - 1 mm max height

PLASTIC SMALL OUTLINE - NO LEAD



SOLDER PASTE EXAMPLE  
BASED ON 0.125 mm THICK STENCIL

EXPOSED PAD 11:  
80% PRINTED SOLDER COVERAGE BY AREA  
SCALE:25X

4218878/B 07/2018

NOTES: (continued)

6. Laser cutting apertures with trapezoidal walls and rounded corners may offer better paste release. IPC-7525 may have alternate design recommendations.

## IMPORTANT NOTICE AND DISCLAIMER

TI PROVIDES TECHNICAL AND RELIABILITY DATA (INCLUDING DATA SHEETS), DESIGN RESOURCES (INCLUDING REFERENCE DESIGNS), APPLICATION OR OTHER DESIGN ADVICE, WEB TOOLS, SAFETY INFORMATION, AND OTHER RESOURCES "AS IS" AND WITH ALL FAULTS, AND DISCLAIMS ALL WARRANTIES, EXPRESS AND IMPLIED, INCLUDING WITHOUT LIMITATION ANY IMPLIED WARRANTIES OF MERCHANTABILITY, FITNESS FOR A PARTICULAR PURPOSE OR NON-INFRINGEMENT OF THIRD PARTY INTELLECTUAL PROPERTY RIGHTS.

These resources are intended for skilled developers designing with TI products. You are solely responsible for (1) selecting the appropriate TI products for your application, (2) designing, validating and testing your application, and (3) ensuring your application meets applicable standards, and any other safety, security, regulatory or other requirements.

These resources are subject to change without notice. TI grants you permission to use these resources only for development of an application that uses the TI products described in the resource. Other reproduction and display of these resources is prohibited. No license is granted to any other TI intellectual property right or to any third party intellectual property right. TI disclaims responsibility for, and you will fully indemnify TI and its representatives against, any claims, damages, costs, losses, and liabilities arising out of your use of these resources.

TI's products are provided subject to [TI's Terms of Sale](#) or other applicable terms available either on [ti.com](https://www.ti.com) or provided in conjunction with such TI products. TI's provision of these resources does not expand or otherwise alter TI's applicable warranties or warranty disclaimers for TI products.

TI objects to and rejects any additional or different terms you may have proposed.

Mailing Address: Texas Instruments, Post Office Box 655303, Dallas, Texas 75265  
Copyright © 2023, Texas Instruments Incorporated