

# User's Guide

## Light Sensor EVMs



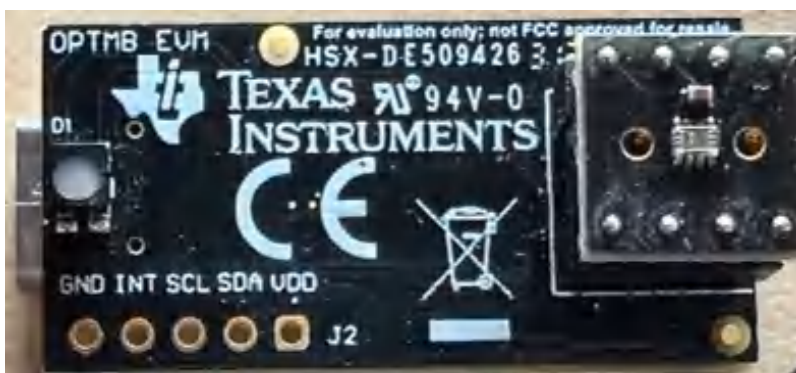
### ABSTRACT

This user's guide describes the characteristics, operation, and use of the OPT light sensor evaluation modules (OPTEVM). The user's guide details how to set up and configure the software and hardware, and reviews various aspects of the program operation. Throughout this document, the terms evaluation board, evaluation module, and EVM are synonymous with the OPT light sensor EVM (OPTEVM). This document also includes an electrical schematic, printed circuit board (PCB) layout drawings, and a parts list for the EVM.

This user's guide is applicable for the following devices:

**Table 1-1. Devices Supported**

Device	Description
OPT3005DTSEVM	Ambient Light Sensor (ALS) for Video Surveillance Cameras
OPT4001DTSEVM	High-Speed, High-Resolution, Digital Ambient Light Sensor (ALS)
OPT4048DTSEVM	High-Speed, High-Precision Tristimulus XYZ Color Sensor



### Table of Contents

<b>1 Overview</b> .....	3
1.1 OPTEVM Kit Contents.....	3
1.2 Related Documentation from Texas Instruments.....	4
<b>2 OPTEVM Hardware Overview</b> .....	5
<b>3 OPTEVM Software</b> .....	6
3.1 Hardware Requirements.....	6
3.2 Software Installation.....	6
3.3 Typical OPTEVM Hardware Setup.....	10
3.4 Launching the OPT300x/4xxxEVM Software.....	11
3.5 OPTEVM Software Operation.....	12
3.6 Controls.....	13
3.7 OPTxxxDTSEVM Variants.....	14
3.8 Scripts Window.....	17
<b>4 Schematic, PCB Layout, and Bill of Materials</b> .....	20
4.1 Coupon Board.....	20
4.2 Motherboard.....	23
<b>5 Troubleshooting</b> .....	27
5.1 Microsoft Windows 7 Manual Driver Installation.....	27

## List of Figures

Figure 1-1. Hardware Included with OPTEVM Kit.....	3
Figure 2-1. OPTEVM Hardware Setup.....	5
Figure 3-1. OPT3004DTSEVM Software-Installation File.....	6
Figure 3-2. OPTEVM Software-Installation Launch.....	6
Figure 3-3. OPTEVM Software-Installation Prompts.....	7
Figure 3-4. OPTEVM Software-Installation Prompts.....	7
Figure 3-5. OPTEVM Software-Installation Prompts.....	8
Figure 3-6. OPTEVM Software-Installation Prompts.....	8
Figure 3-7. OPTEVM Software-Installation Prompts.....	9
Figure 3-8. OPTEVM Software-Installation Prompts.....	9
Figure 3-9. Typical Hardware Connection.....	10
Figure 3-10. Typical Response After Connecting OPTEVM to the Computer.....	10
Figure 3-11. OPTEVM Main Operation Screen.....	11
Figure 3-12. Hardware Error Message.....	11
Figure 3-13. GUI Capture Running (single channel).....	12
Figure 3-14. OPT4048DTSEVM CIE XY Window.....	14
Figure 3-15. OPT4048DTSEVM Lux Live Window.....	15
Figure 3-16. OPT4048DTSEVM Channel Live Window.....	16
Figure 3-17. Latte Scripts Window.....	17
Figure 3-18. Registers View Example for OPT4xxx Devices.....	19
Figure 4-1. OPT3004 Coupon Board Schematic.....	20
Figure 4-2. PCB Top Layer.....	21
Figure 4-3. PCB Bottom Layer.....	21
Figure 4-4. PCB Top-Layer Assembly Drawing.....	22
Figure 4-5. PCB Bottom-Layer Assembly Drawing.....	22
Figure 4-6. OPTMB EVM Board Schematic.....	23
Figure 4-7. PCB Top Layer.....	24
Figure 4-8. PCB Bottom Layer.....	24
Figure 4-9. PCB Top-Layer Assembly Drawing.....	25
Figure 4-10. PCB Bottom-Layer Assembly Drawing.....	25
Figure 5-1. OPTEVM on Microsoft® Windows® 7 With Drivers not Installed.....	27

## Trademarks

Windows 10®, Microsoft®, and Windows® are registered trademarks of Microsoft Corporation. All trademarks are the property of their respective owners.

## 1 Overview

Texas Instruments has multiple families of light sensor parts. This EVM user's guide supports all the devices listed above. Each of these parts is a light sensor integrated circuit (IC) with a digital output and works with the I<sup>2</sup>C protocol; making the device an excellent choice for many applications. The OPTEVM is a platform for evaluating the performance of the multiple light sensor IC under various conditions. The OPTEVM consists of two PCBs. The first PCB is the OPTMB EVM board that communicates with the computer, provides power, and sends and receives appropriate digital signals. The second PCB is the OPTCB coupon board, which contains the light sensor IC for evaluation and support circuitry.

### 1.1 OPTEVM Kit Contents

Table 1-1 summarizes the contents of the OPTEVM kit. Figure 1-1 shows the included hardware. Contact the [Texas Instruments Product Information Center](#) nearest you if any component is missing. TI highly recommends to check the Light Sensor product folder on the TI web site at [www.ti.com](http://www.ti.com) for the latest versions of the released software.

**Table 1-1. OPTEVM Kit Contents**

Item	Quantity
Coupon board with OPT300x/4xxx IC (Installed on OPTMBEVM)	1
OPTMBEVM board	1
USB type A to type C cable	1



**Figure 1-1. Hardware Included with OPTEVM Kit**

## 1.2 Related Documentation from Texas Instruments

The following documents provide information regarding Texas Instruments' integrated circuits used in the assembly of the OPTEVM. This user's guide is available from the TI web site under literature number **SBOU293**. Any letter appended to the literature number corresponds to the document revision that is current at the time of the writing of this document. The latest revision can be found by clicking the link and is also available from the [TI web site](#), the Texas Instruments' Literature Response Center at (800) 477-8924, and the Product Information Center at (972) 644-5580. When ordering, identify the document by both title and literature number.



## 2 OPTEVM Hardware Overview

Figure 2-1 shows the system setup for the OPTEVM. The computer runs the graphical user interface (GUI) software that communicates with the OPTMB EVM board over a USB connection. The OPTMB EVM board has a USB Type C port and ships with a USB-C to USB-A cable. The OPTMB EVM board acts as a bridge between the software running on the PC and the OPTCB coupon board. The MSP430 on the OPTMB EVM board receives USB commands from the PC and communicates with the light sensor over I<sup>2</sup>C.

The OPTCB coupon board consists of the light sensor IC, decoupling capacitor, and 8 pins. The pins create connections for the power, I<sup>2</sup>C, and an interrupt signal between the OPTCB coupon board and the OPTMB EVM board. For evaluation purposes, the OPTCB coupon board can be removed from the OPTMB EVM board to use with other platforms. The OPTMB EVM board also has an unpopulated 5-pin header footprint for easy access to the supply, ground, I<sup>2</sup>C, and interrupt lines.

The EVM ships with the OPTCB coupon board plugged into the motherboard. If not already assembled, then the basic hardware setup for the OPTEVM involves plugging the coupon board into the OPTMB EVM board socket. Take special care to make sure the OPTCB coupon board is oriented correctly as shown in Figure 1-1. Then connect the USB cable. This section presents the details of this procedure.

### CAUTION

Many of the components on the OPTEVM are susceptible to damage by electrostatic discharge (ESD). Customers are advised to observe proper ESD handling precautions when unpacking and handling the OPTEVM, including the use of a grounded wrist strap at an approved ESD workstation.

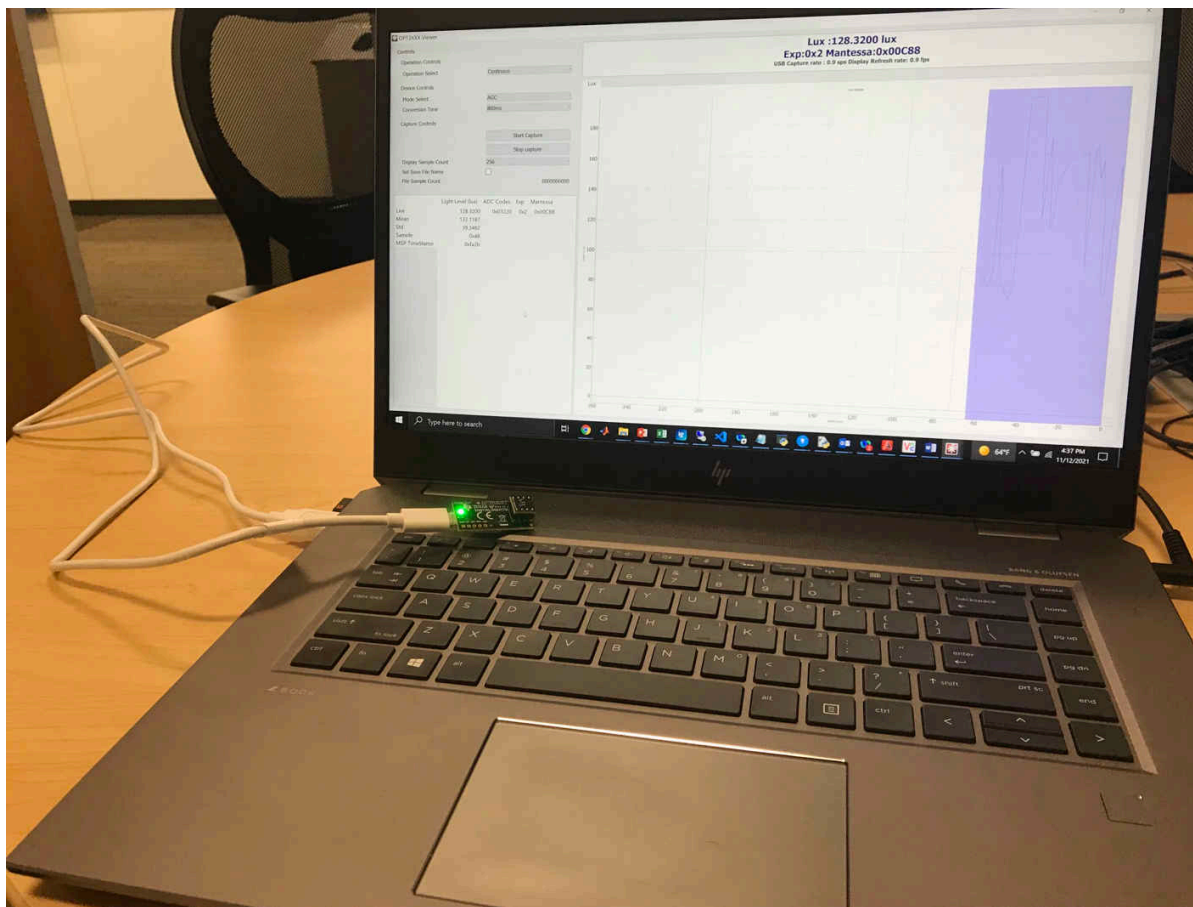


Figure 2-1. OPTEVM Hardware Setup

### 3 OPTEVM Software

This section describes the installation and operation of the OPTEVM software. An OPTEVM uses the TI Latte software, which is available for download on the EVM page.

#### 3.1 Hardware Requirements

The OPTEVM software has been tested on the Windows 10® operating system (OS) with United States regional settings. The software should function correctly on other Windows XP, Windows Vista, Windows 7 and Windows 8.

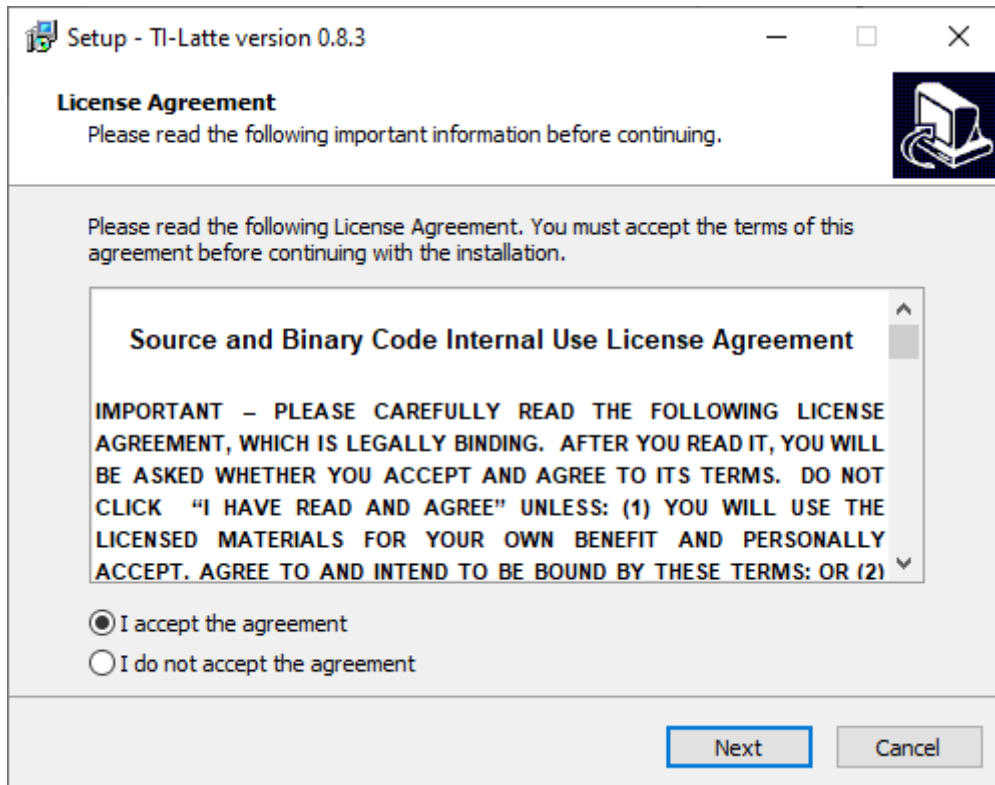
#### 3.2 Software Installation

The OPTEVM software is available through the light sensor IC Product Folder on the TI web site ([www.ti.com](http://www.ti.com)). The product folder is named corresponding to the specific device part number. To install the software to your computer, navigate to the OPTEVM software. For example, the OPT4001DTS IC is called OPT4001DTSEVM. Open the installer directory. Launch the installation file, for example: *OPT4001DTS\_EVM\_Latte.exe*, as shown in the figure below.



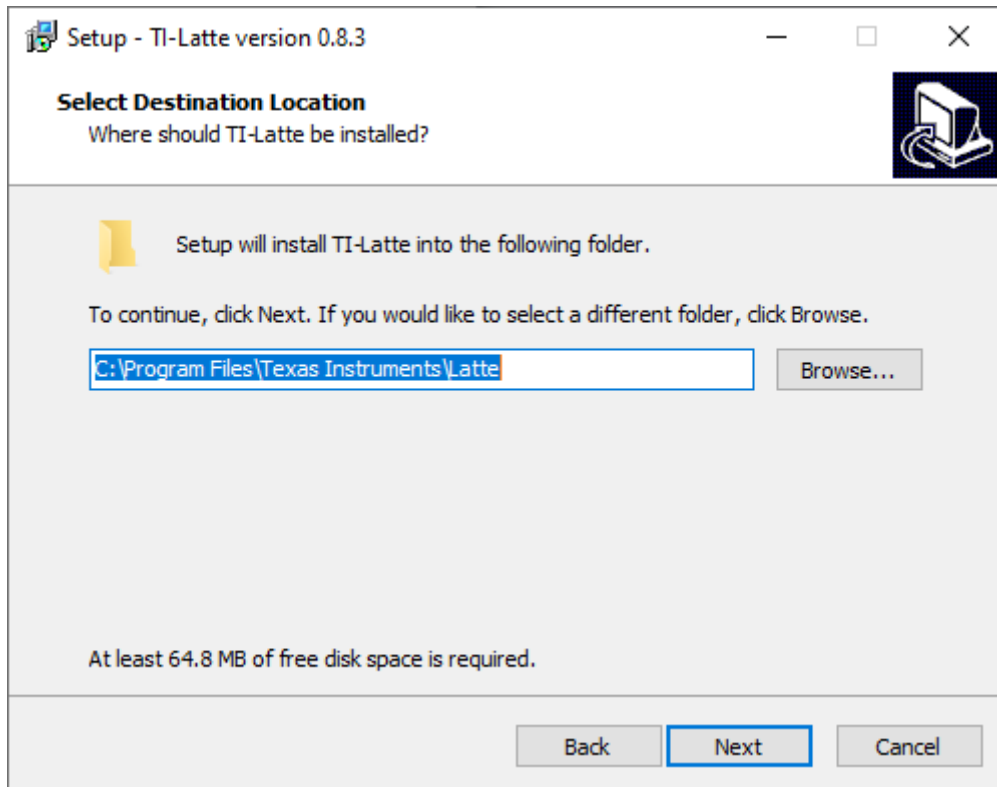
**Figure 3-1. OPT3004DTSEVM Software-Installation File**

The OPTEVM software then begins the installation process, as shown in [Figure 3-2](#).

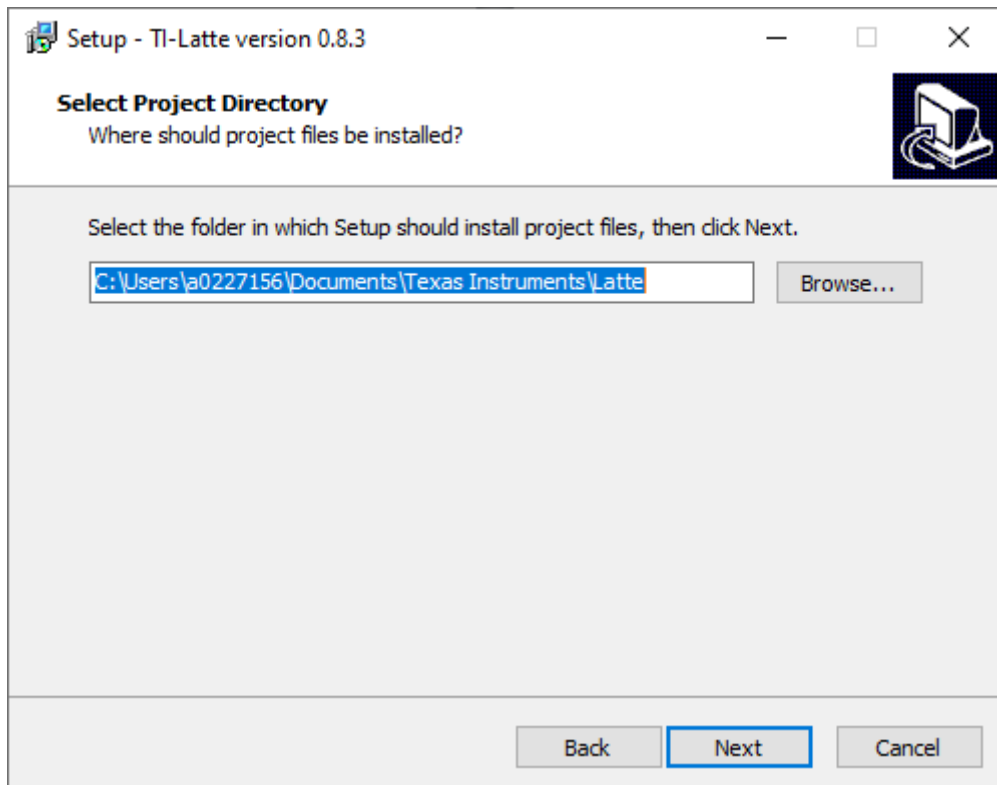


**Figure 3-2. OPTEVM Software-Installation Launch**

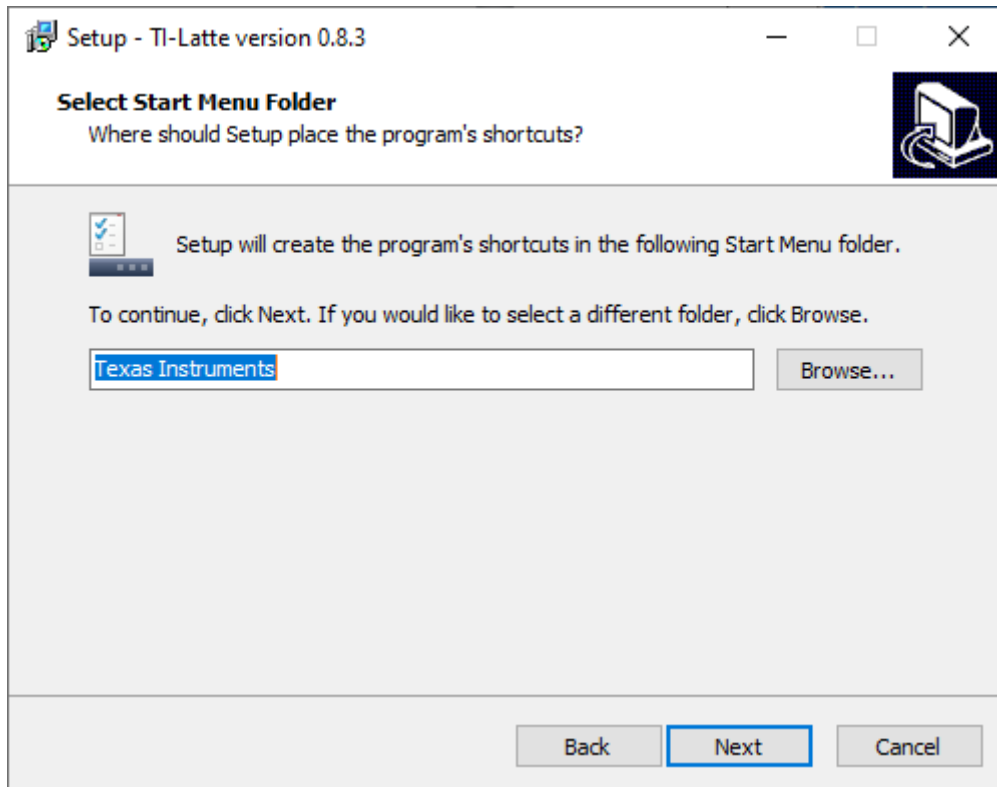
Follow the prompts as shown in [Figure 3-3](#) to [Figure 3-8](#) to install the OPTEVM software.



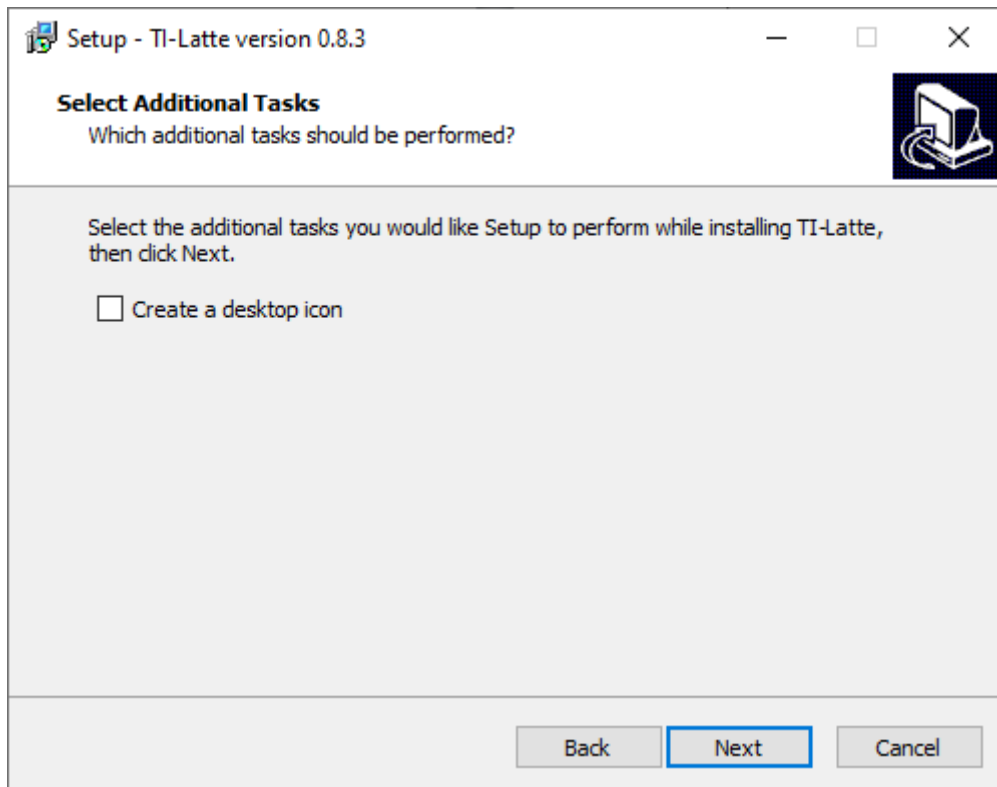
**Figure 3-3. OPTEVM Software-Installation Prompts**



**Figure 3-4. OPTEVM Software-Installation Prompts**

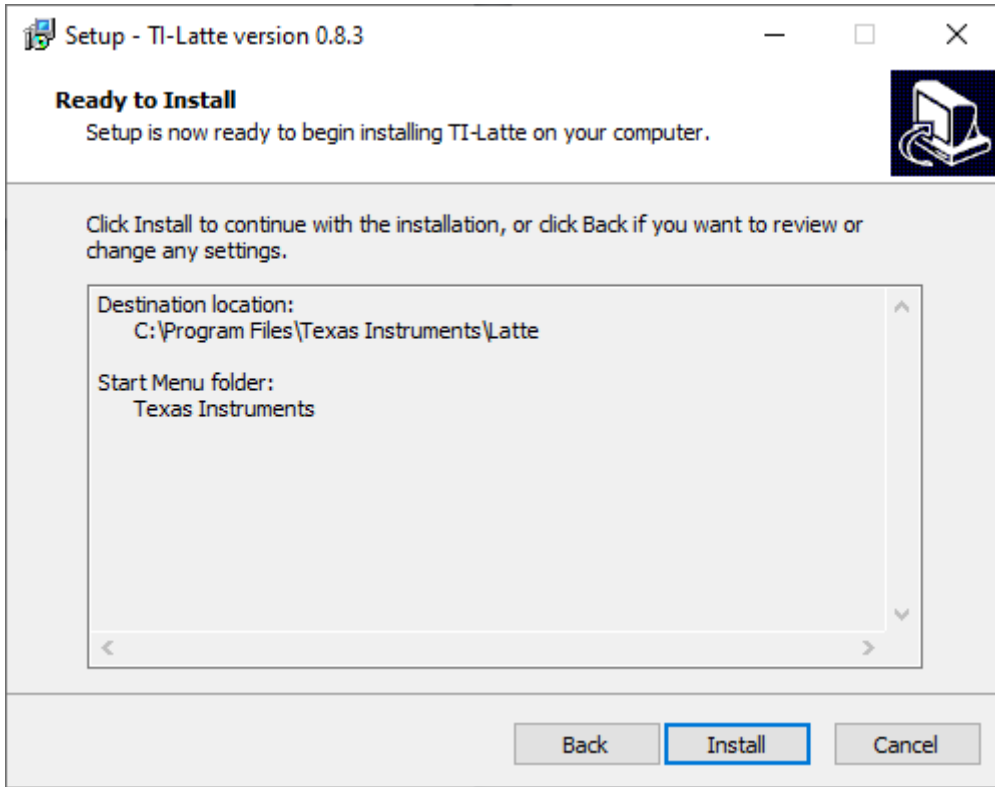


**Figure 3-5. OPTEVM Software-Installation Prompts**

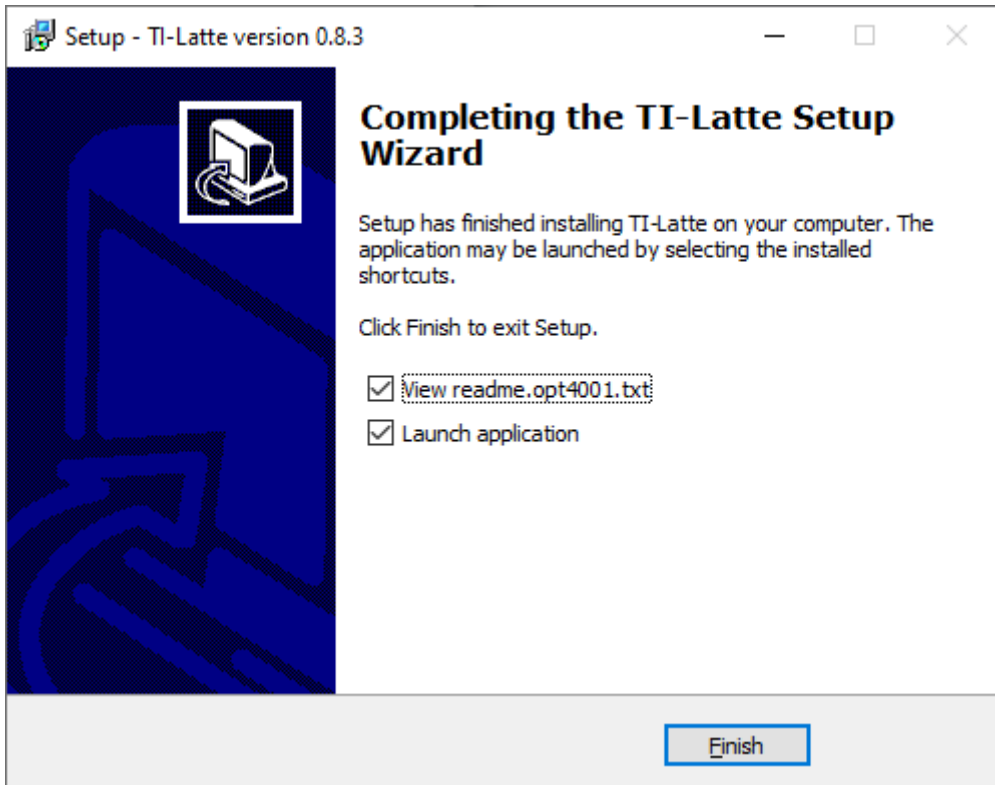


**Figure 3-6. OPTEVM Software-Installation Prompts**





**Figure 3-7. OPTEVM Software-Installation Prompts**

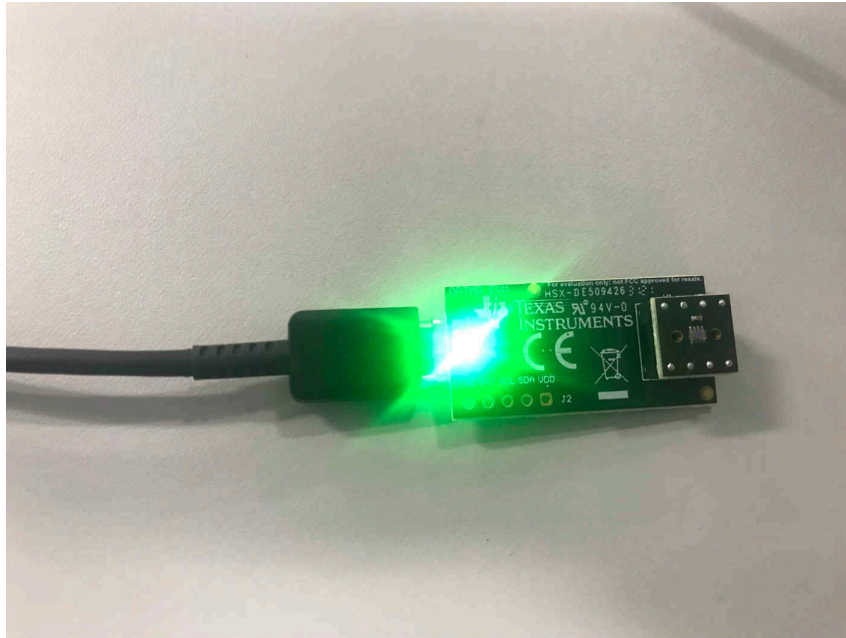


**Figure 3-8. OPTEVM Software-Installation Prompts**

The OPTEVM GUI software is now installed.

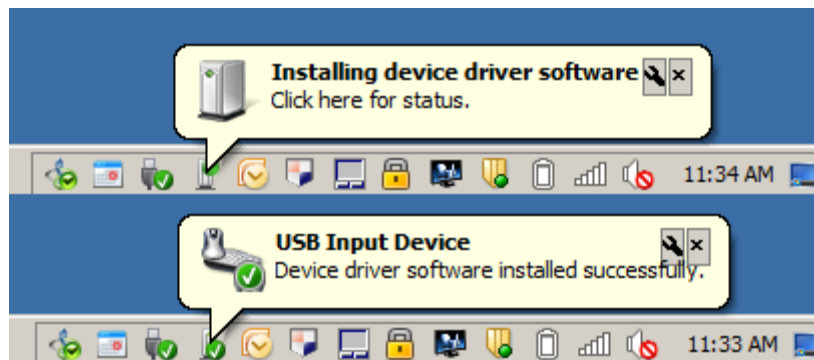
### 3.3 Typical OPTEVM Hardware Setup

Plug the male USB-C cable to the OPTMB EVM board and then plug the male USB-A cable into the computer. The green light will light up on the EVM as shown in the figure below.



**Figure 3-9. Typical Hardware Connection**

The figure below shows the typical response when the OPTEVM is plugged into the USB port of the computer for the first time. Typically, the computer responds with a *Found New Hardware, USB Device* pop-up dialog window. The pop-up window then typically changes to *Found New Hardware, USB Human Interface Device*. This pop-up indicates that the device is ready to be used.



**Figure 3-10. Typical Response After Connecting OPTEVM to the Computer**

Connect the EVM via USB to the PC. If Windows shows a notification that a driver is not found for the device connected, then see the instructions to manually install drivers in [Section 5.1](#) before proceeding.

### 3.4 Launching the OPT300x/4xxxEVM Software

With the OPTEVM properly connected, launch the Latte OPTEVM GUI software from the Windows *Start* menu. The software launches with a screen similar to that shown in Figure 3-11. The exact GUI screen varies based on the EVM variant. Details on each variant are covered in the following section.

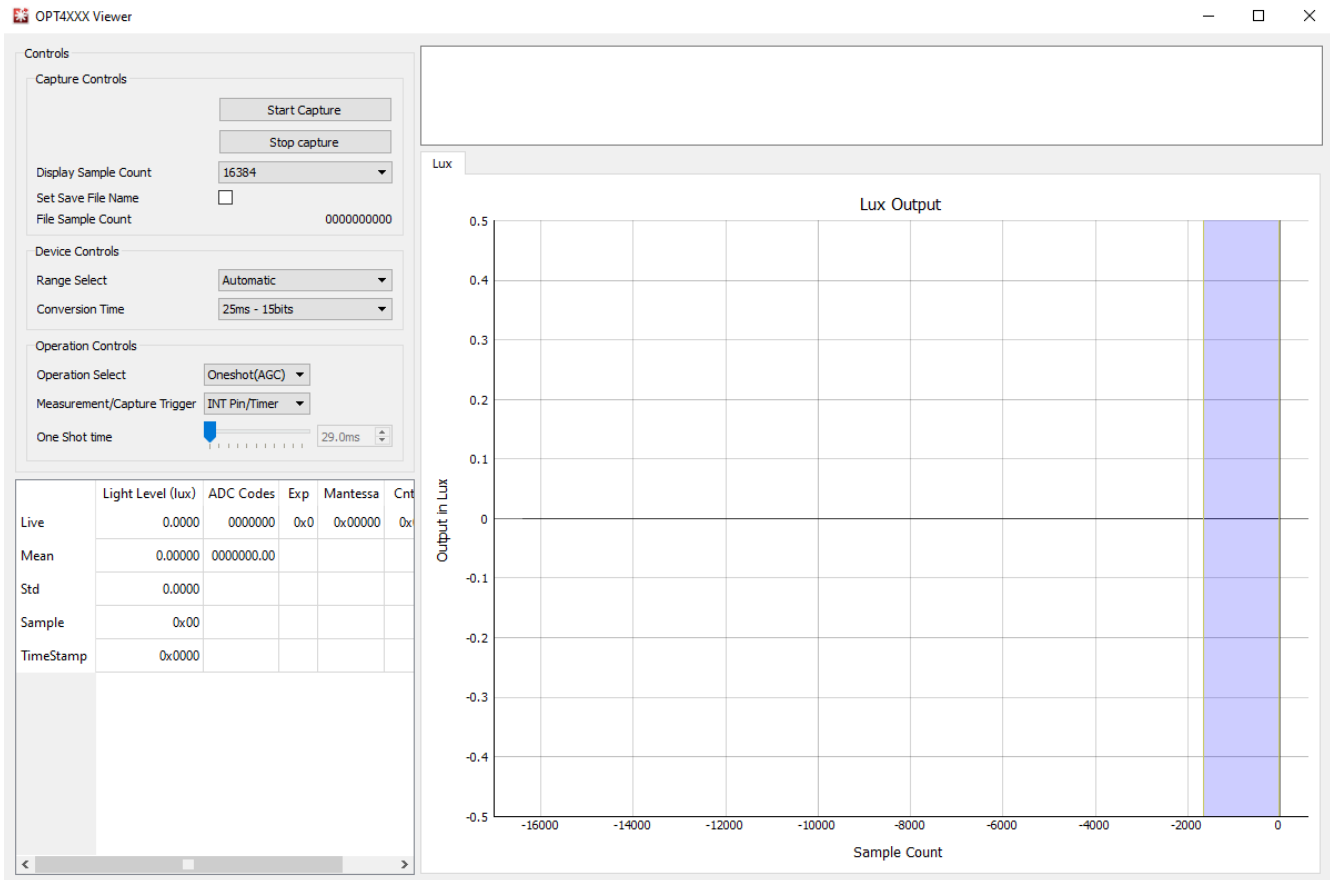


Figure 3-11. OPTEVM Main Operation Screen

If the message shown in Figure 3-12 appears when the OPTEVM GUI software is launched, then this means that the OPTMB EVM board was not detected. The device name varies according to the OPTEVM selected. Check the USB connection and that the OPTMB EVM board appears in the device manager as shown. A green light will appear on the motherboard if the motherboard is receiving power from the PC and the GUI *Start capture* button has not been clicked.

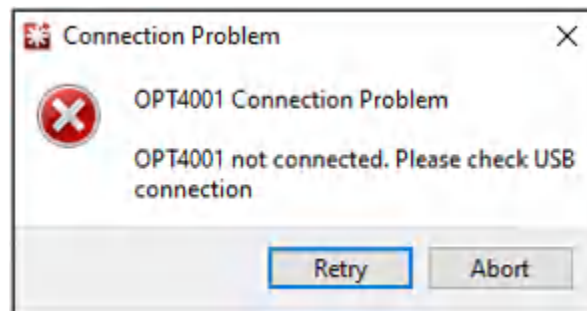


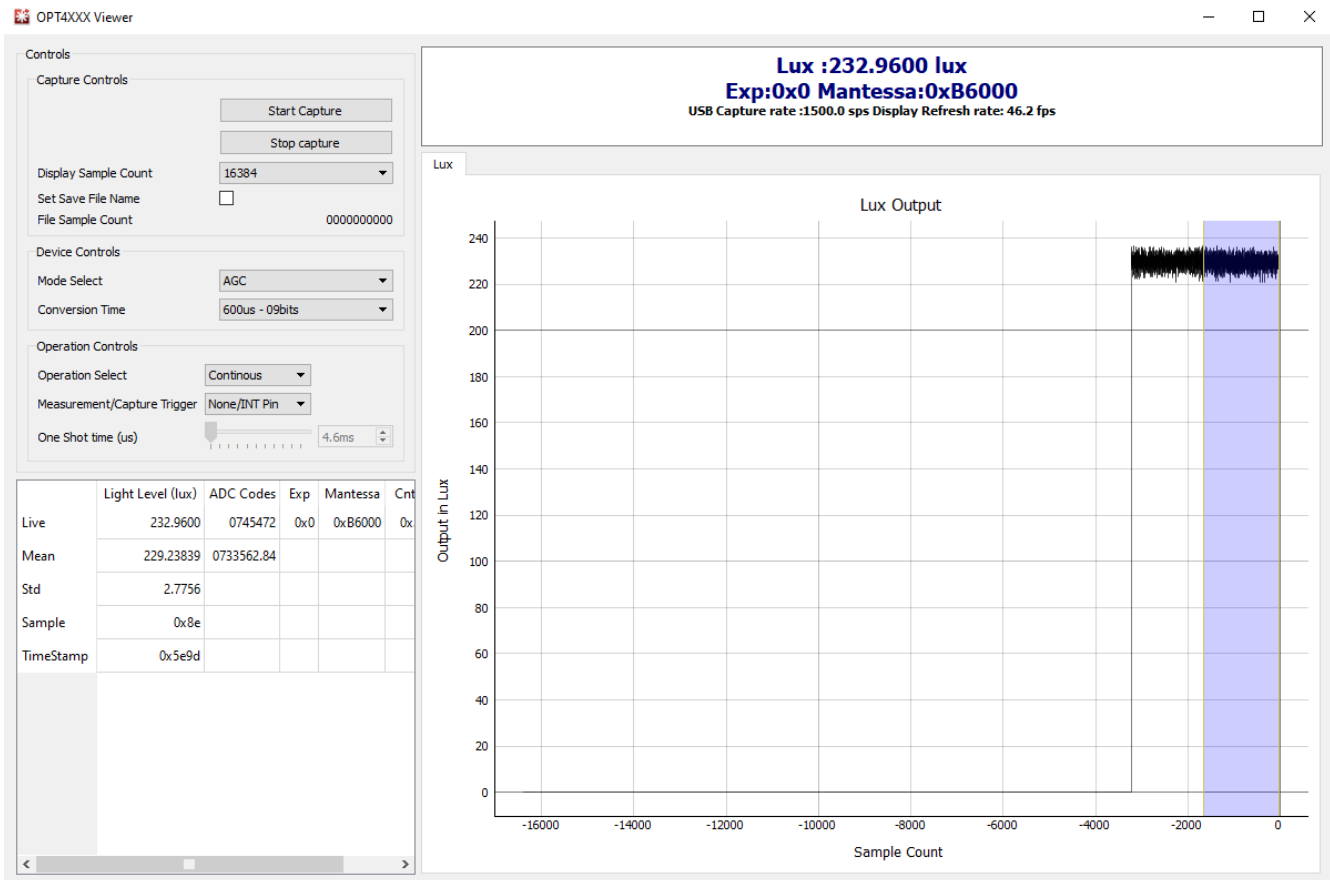
Figure 3-12. Hardware Error Message

### 3.5 OPTEVM Software Operation

This section primarily discusses how to operate the OPTEVM software. The GUI has a primary window that is used to configure and read from the OPTEVM, along with two other windows that are used to access different features of the OPTEVM. Basic GUI functionality and a description of the tabs are also presented in this section.

#### 3.5.1 Getting Started

To quickly start using the device, click the *Operation Select* dropdown and select *Continuous* to bring the device out of power down mode. Then click *Start Capture* to begin data capture. The green LED on the motherboard turns off. Lux data appears above the lux plot as shown. The plot also starts to populate with the device lux readings.



**Figure 3-13. GUI Capture Running (single channel)**

If the GUI is not responsive, then check the other Latte scripts window, which is minimized by default. If the message *Operation I2C Register Read for command [REGRx01] Failed.* is displayed, then this means that the light sensor IC or the OPTCB board is not detected by the motherboard. Ensure the OPTCB board is plugged in and properly oriented.

#### 3.5.2 Feature Descriptions

##### 3.5.2.1 Lux Plot

For all single channel EVMs (non-color EVMs), the device will output a single value (for example, a lux reading indicating the ambient light level). In the center of the GUI window, there is a plot showing the lux reading from the device on the y-axis and the sample number on the x-axis. The plot settings can be tweaked by right clicking on the plot. The x-axis and y-axis options under the right-click menu allow the range of x and y-axes displayed to be changed. There is also an auto option that will dynamically change the range to match the data. Scrolling will zoom in to or zoom out from the plot. Left-clicking and dragging will display a yellow rectangle that will, upon releasing the mouse, zoom the data to the rectangle drawn. Right-clicking and dragging up or down zooms the

y-axis. Right-clicking and dragging right or left will zoom the x-axis. Right clicking and selecting *View All* will reset the view.

For color EVMs, each channel output is displayed on the same plot with the readings at the top of the window updated to display one reading per channel instead of a single reading as shown in [Figure 3-16](#).

### 3.5.2.2 Mean, Std, and the Blue Slider

There is a blue slider on the lux plot shown on the right side of the plot in the [Figure 3-13](#). Mean and Std columns in the table where capture data is displayed are calculated from only the data within the blue slider. Left-clicking on the middle of this slider and dragging moves the slider. Left-clicking on the edge of either side of the slider and dragging will adjust the size of the slider. This allows the mean and standard deviation of the distance, phase, and amplitude to be computed for any continuous portion of the displayed data. If capture is running this data updates in real-time along with the data in the Live column.

## 3.6 Controls

### 3.6.1 Capture Controls

#### 3.6.1.1 Start Capture and Stop Capture

At the top left of the plot are two buttons to push. The *start capture* button will begin capturing data based on the capture controls, device controls, and operations controls section below the two buttons. The *stop capture* button will end the process for capturing data

#### 3.6.1.2 Display Sample Count

The *display sample count* drop-down selector selects how many samples are displayed on the x-axis of the plot.

#### 3.6.1.3 Save to File

The *Set save to file name* check box allows the data captured in the GUI to be dumped to a CSV file. Clicking this check box displays a windows file selector screen. Select the directory to store the CSV and set the name for the CSV. After clicking *save* in the pop up window, press the *start capture* button to start saving data and click the *stop capture* button to copy all the data into the indicated CSV file. When capturing data with save enabled, the GUI initially dumps the data to temporary .npy files. After clicking *stop capture*, this data is written over to the CSV file and .npy files removed.

### 3.6.2 Device Controls

#### 3.6.2.1 Mode Select

The *mode select* drop down changes the device gain range setting mode. The device supports automatic gain control (AGC), which is the recommended mode setting for most use cases, or the gain range of the device can be selected manually using this drop-down menu.

#### 3.6.2.2 Conversion Time

The device supports twelve (12) *conversion times*: ranging from 600  $\mu$ s to 800 ms, which can be selected using the respective drop-down menu. Each conversion time shows the number of resolution bits obtainable with that conversion time.

### 3.6.3 Operation Controls

#### 3.6.3.1 Operation Select

The *operation select* drop-down menu allows the device operating mode to be switched between the PWRDN, continuous, oneshot(AGC) and oneshot modes. PWRDN is the power-down or standby mode where the device enters a low power state. There is no active light sensing or conversion in the mode. Continuous mode measures and updates the output registers continuously determined by the conversion time. Oneshot keeps the device in standby mode and a conversion is triggered by an interrupt (INT Pin) or a timer measurement. This mode uses auto-range selection logic from the previous selection to decide the range for the current trigger. Oneshot(AGC) keeps the device in standby mode and a conversion is triggered by an interrupt (INT Pin) or a



timer measurement. In this mode, every one shot trigger forces a full reset on the auto-ranging control logic and a fresh auto-range detection is initiated ignoring the previous measurements.

### 3.6.3.2 Measurement/Capture Trigger

The *measurement/Capture Trigger* drop-down menu allows the device measurement and capture trigger to be switched between the INT Pin/Timer, Timer/Timer, Timer/INT Pin and Timer/INT PinBy2 modes. This can only be selected when operating in oneshot(AGC) or oneshot mode. INT Pin/Timer has an input to trigger a measurement. Since the INT pin is used as input, there is not hardware interrupt to indicate the completion of measurement so Timer is used to keep time from the trigger measurement and read out output registers. With a Timer measurement, the next measurement is set by the timer and the INT Pin, INT PinBy2 (every second INT Pin) or Timer can indicate measurement completion to read out output registers.

### 3.6.3.3 One Shot Time ( $\mu$ s)

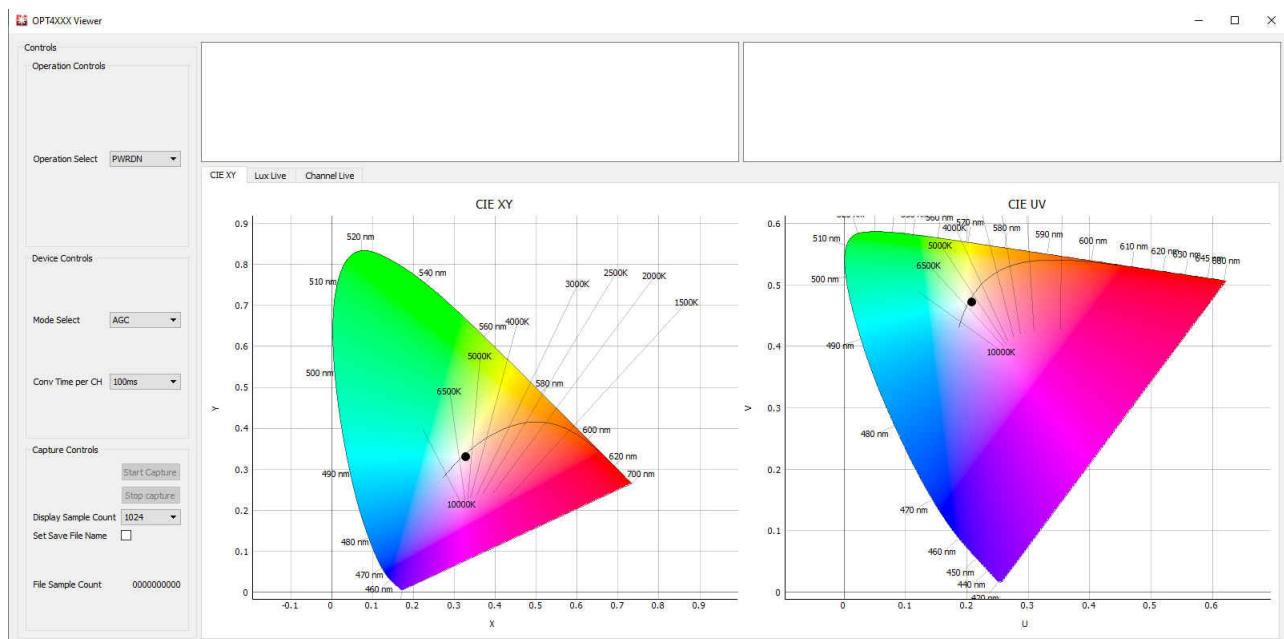
The one shot time slider sets the timer duration while using oneshot(AGC) and oneshot mode.

## 3.7 OPTxxxDTSEVM Variants

With different OPTEVM variants that are listed in [Table 1-1](#), there are slight differences in the GUI. Most of the controls, such as the capture controls, the device controls, and the operations, control are the same. The difference in each variant are listed below.

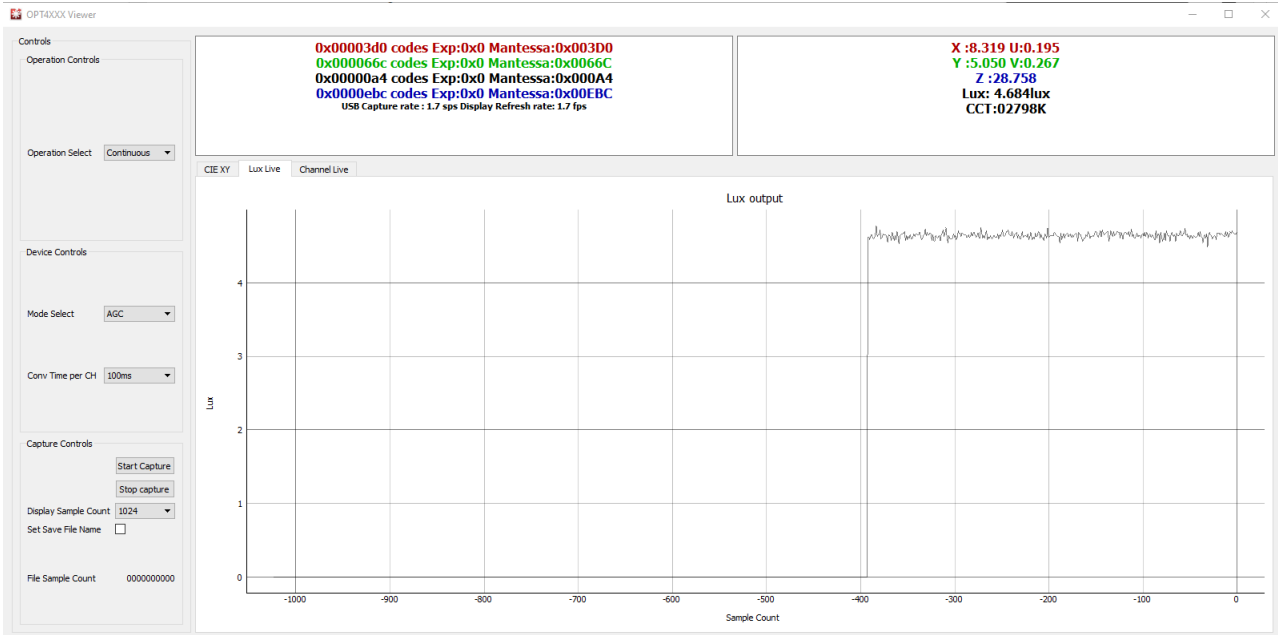
### 3.7.1 OPT4048DTSEVM

The OPT4048DTSEVM GUI launches with three window options.



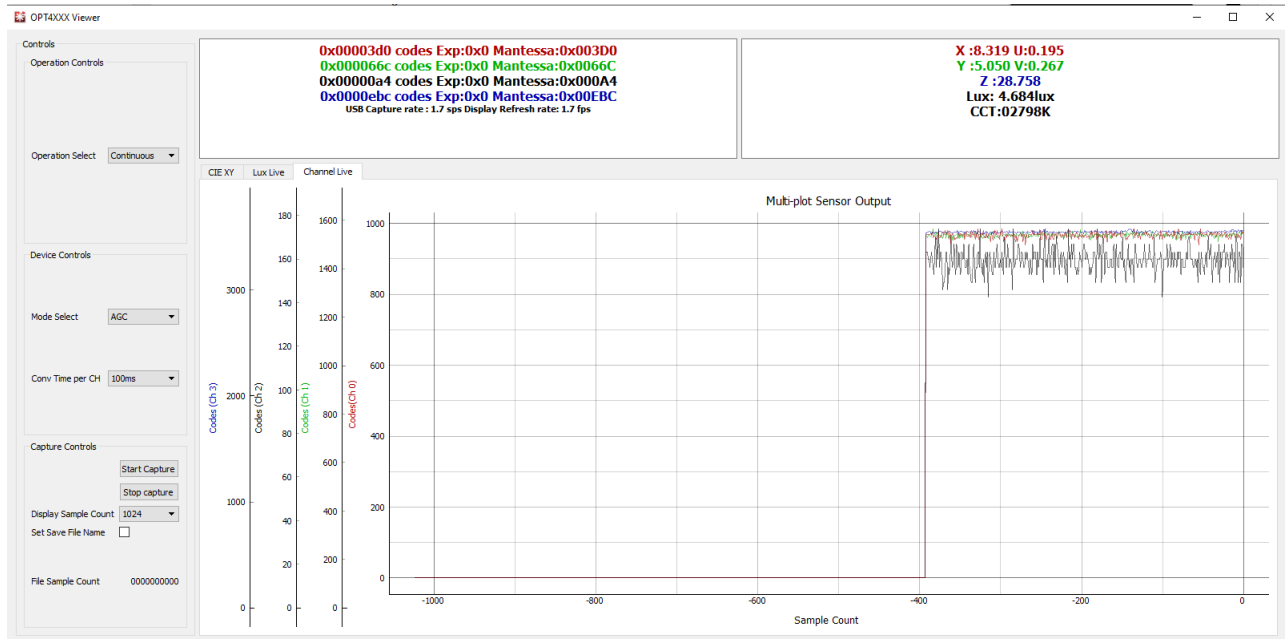
- A. The CIE XY window shows the CIE 1931 color space in both XY and UV in graph form. The black dot represents the color sensed by the OPT4048 as shown in [Figure 3-14](#).

**Figure 3-14. OPT4048DTSEVM CIE XY Window**



A. The Lux Live window, shown in [Figure 3-15](#), shows the live lux value sensed by the OPT4048 across the sample count.

**Figure 3-15. OPT4048DTSEVM Lux Live Window**



A. The Channel Live window, shown in Figure 3-16, shows the live register codes of each channel around the sample count.

**Figure 3-16. OPT4048DTSEVM Channel Live Window**

### 3.8 Scripts Window

When Latte is launched the GUI window appears front and center. However, there is a second window that is minimized at launch. This is the scripts window and exposes some more advanced features of the Latte platform. See [Latte Scripts Window](#).

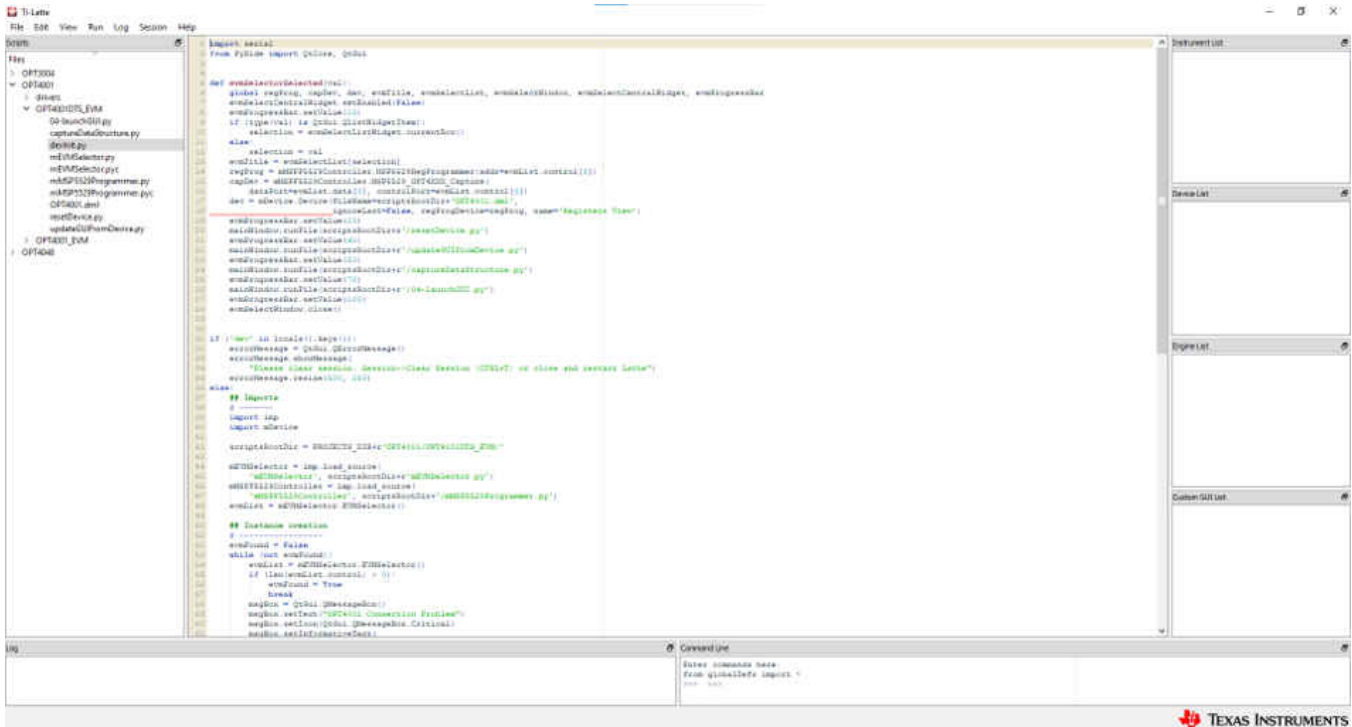


Figure 3-17. Latte Scripts Window

The scripts window also provides access to the device registers view that displays the stored value of the device registers and allows them to be changed directly. Launch the registers view by double clicking on the *Registers View* button under the *Device List* box on the right side of the screen.

## 3.8.1 Additional Features of the Scripts Window

### 3.8.1.1 Hidden IDE Window

The Latte program runs a number of python scripts in the background to capture and display data from the EVM. These scripts allow for initialization of the device including loading calibration data from the EVM flash memory, launching a live view window with measurement plot and readings, and additional functionality such as reading from the flash and selecting a specific LED current for the device to use. For advanced users or users looking for more flexibility when using the OPTEVM, these python scripts are available in an integrated development environment (IDE) window that is minimized when TI-Latte is launched. The IDE window allows advanced users to customize the existing scripts or write new scripts.

After launching Latte, expand the light sensor directory on the left hand side of the window under Files by clicking the triangle to the left of the directory name. This displays the light sensor folder. Further expanding the light sensor folder displays all the example scripts as shown in [Latte Scripts Window](#).

### 3.8.1.2 devInit.py

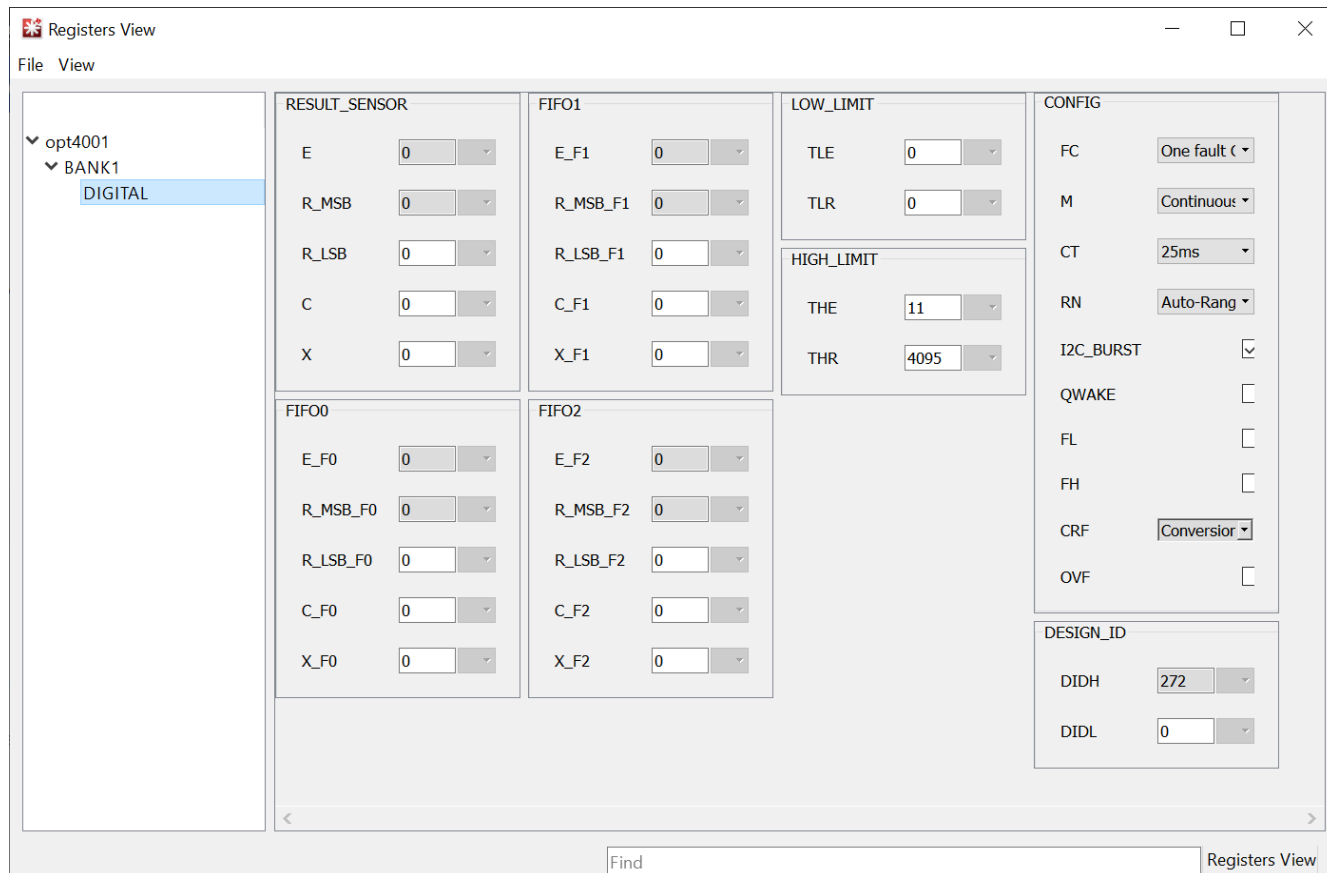
Open the devInit.py script by clicking on the corresponding file in the light sensor folder on the left side of the screen. This displays the contents of the script on the center of the window. With devInit.py still selected in TI-Latte, click Run>Buffer from the top menu bar of TI-Latte (or press F5) to run the script. Once completed, the live view GUI is opened in a new window. More details on the live view GUI are given in the following section. Additional info is also displayed in the log window in the lower left-hand corner of the main window.

### 3.8.1.3 04-launchGUI.py

A liveview GUI window is launched when running the devInit.py script. This window allows data from the OPTEVM to be viewed on a graph in real time. The GUI is created in the launchGUI.py example script. When running devInit.py, the launchGUI.py script is automatically run. However, if the GUI window is closed, then the window can be re-launched by directly running the launchGUI.py script. To do this, select the launchGUI.py script and click Run>Buffer or press F5.



### 3.8.2 Overview of Device Registers: OPT4xxx Devices



**Figure 3-18. Registers View Example for OPT4xxx Devices**

Registers E, R\_MSB, R\_LSB, C and X are the result registers for single channel devices with registers 0x02 through 0x07 as FIFO registers. The result register provides the output data from the device as an exponent and mantissa value indicated as e and r in the register view. The mantissa is split between registers 0x00 and 0x01 as R\_MSB and R\_LSB. A sample counter (C) and CRC check bits (X) are also contained in register 0x01.

For color sensors register 0x00 through 0x07 are the result registers for each channel.

Registers 0x0A, 0x0B, and 0x0C are the configuration registers and provide feedback about the state of the device; the bit names and full descriptions are shown in the device data sheet. Each of the read-only status bits are greyed out and cannot be changed. Registers x08 and x09 allow low and high limits, respectively, to be set. These registers are used in certain interrupt reporting modes. The Design\_ID is contained in register 0x11.

## 4 Schematic, PCB Layout, and Bill of Materials

### 4.1 Coupon Board

#### 4.1.1 Schematic

Figure 4-1 shows the schematic of the OPT3004DTS coupon board. C1 is a bypass capacitor for device VDD. For other OPT300x/4xxx device variants the pinout and schematic is the same except for the change to the IC in the BOM.

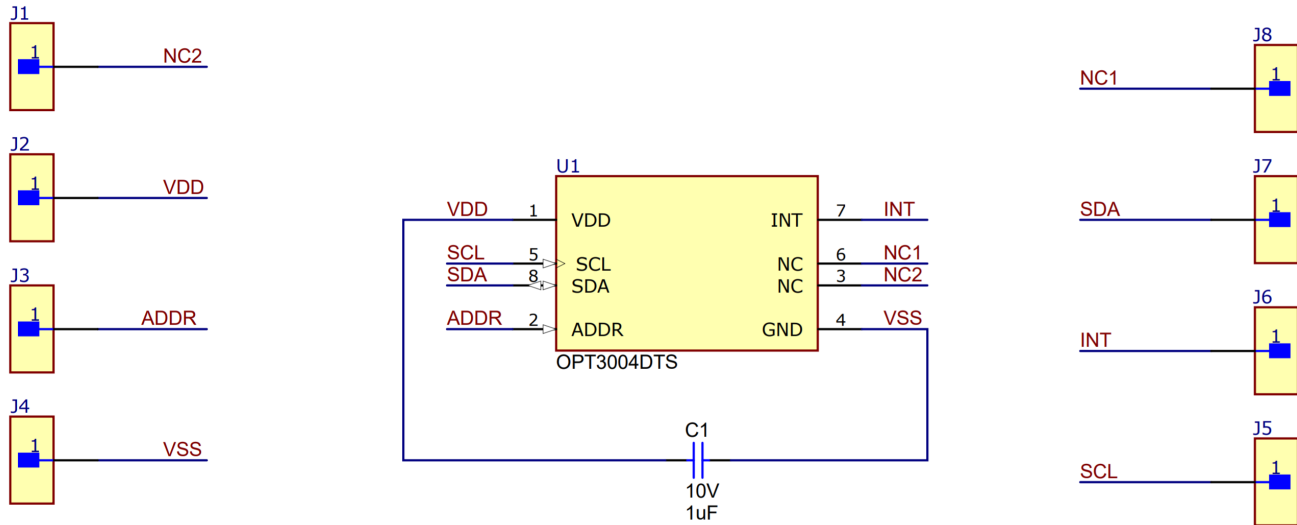


Figure 4-1. OPT3004 Coupon Board Schematic

### 4.1.2 PCB Layout DTS Package

Figure 4-2 and Figure 4-3 show the top and bottom PCB layers, respectively, of the coupon board. Figure 4-4 and Figure 4-5 show the assembly drawings of the top and bottom PCB layers, respectively.

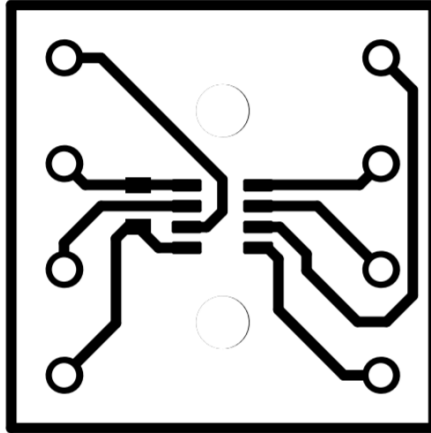


Figure 4-2. PCB Top Layer

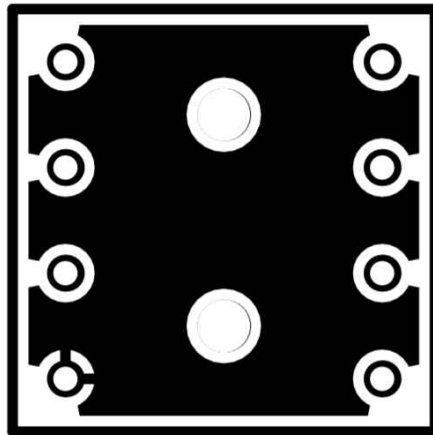
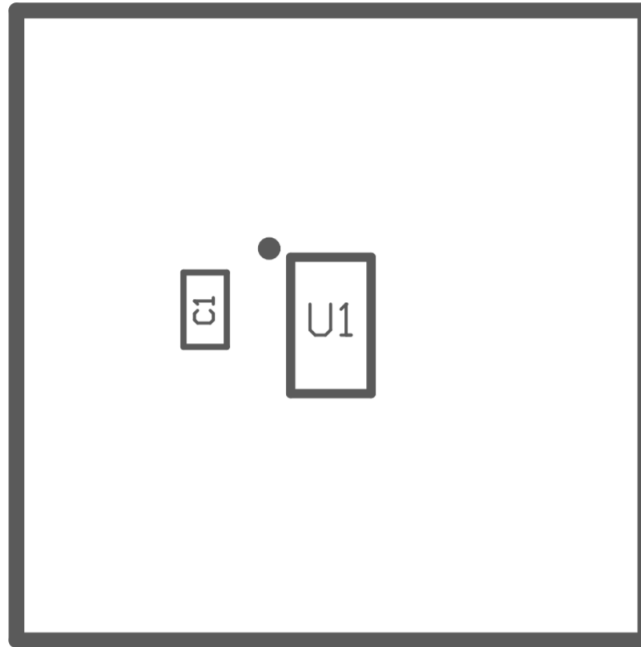
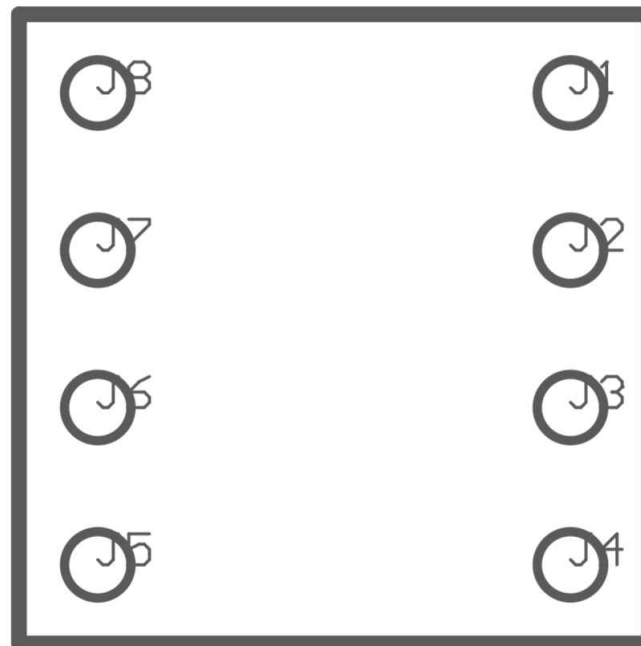


Figure 4-3. PCB Bottom Layer



**Figure 4-4. PCB Top-Layer Assembly Drawing**



**Figure 4-5. PCB Bottom-Layer Assembly Drawing**

### 4.1.3 Bill of Materials

Table 4-1 lists the bill of materials for the OPT4001DTS coupon board. For other light sensor device variants the BOM is the same except for the change to the IC (U1).

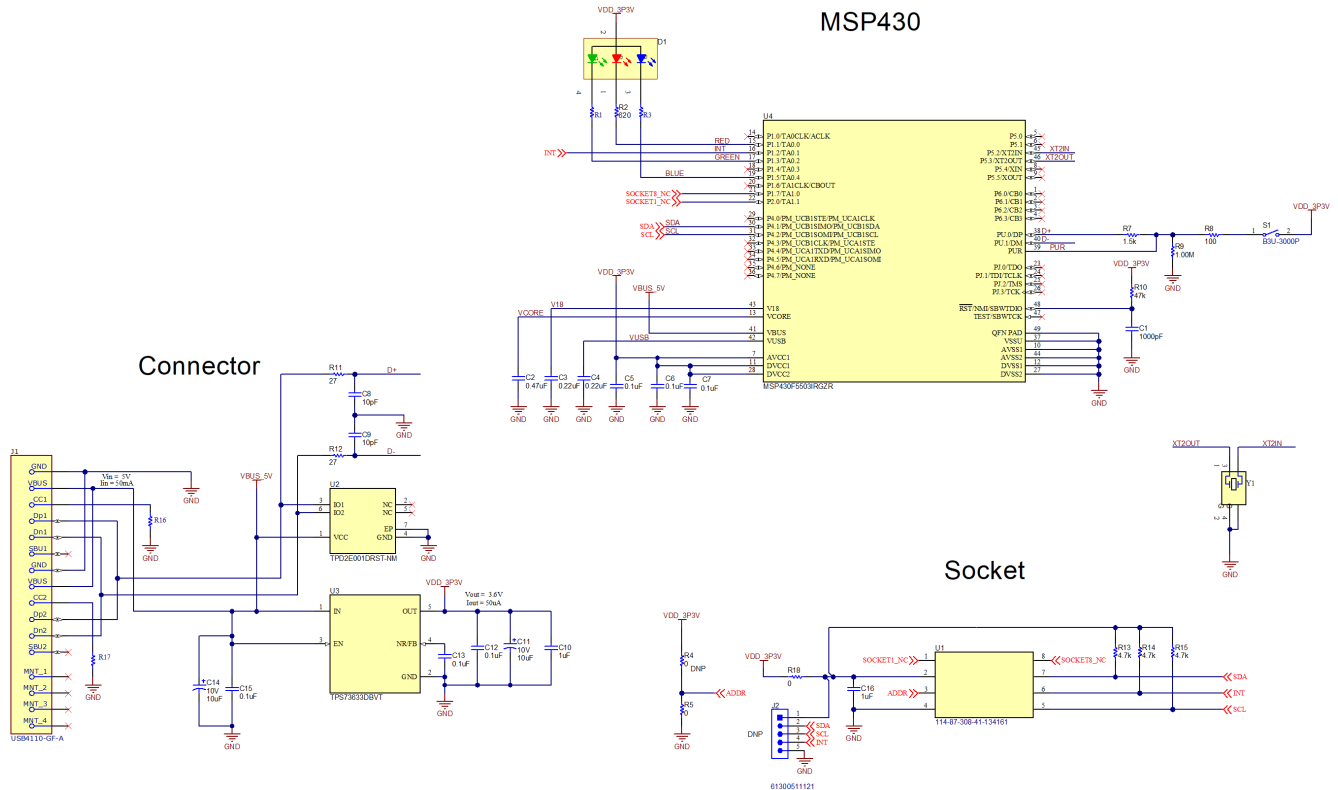
**Table 4-1. OPTxxxDTS Coupon Bill of Materials**

Designator	Quantity	Description	PartNumber	Manufacturer
C1	1	CAP. CERM, 1 uF, 10 V, +/- 10%, X7S, AEC-Q200 Grade 1, 0402	GCM155C71A105KE38D	MuRata
J1, J2, J3, J4, J5, J6, J7, J8	8	PC Pin Terminal Connector Through Hole Gold 0.017" (0.43mm) Dia	3121-2-00-15-00-00-08-0	Mill-Max
U1	1	TI Light Sensor	OPTxxxDTS	Texas Instruments

## 4.2 Motherboard

### 4.2.1 Schematic

Figure 4-1 shows the complete schematic of the OPTMB EVM board. The schematic is split into three sections: connector, MSP430, and socket. A USB type C connector is used to interface with the PC. The MSP430 microcontroller allows the PC to interface with the light sensor through I<sup>2</sup>C. The coupon board containing the light sensor plugs into the OPTMB EVM board through the socket. The OPTMB EVM board provides easy access to the I<sup>2</sup>C, INT, VDD, and GND lines. The header J2 is depopulated on the OPTEVM by default and is labeled through hole pads can be used to access the lines. Alternatively, a header can be populated at J2 for easier access.



**Figure 4-6. OPTMB EVM Board Schematic**



#### 4.2.2 PCB Layout

Figure 4-2 and Figure 4-3 show the top and bottom PCB layers, respectively, of the test board. Figure 4-4 and Figure 4-5 show the assembly drawings of the top and bottom PCB layers, respectively.

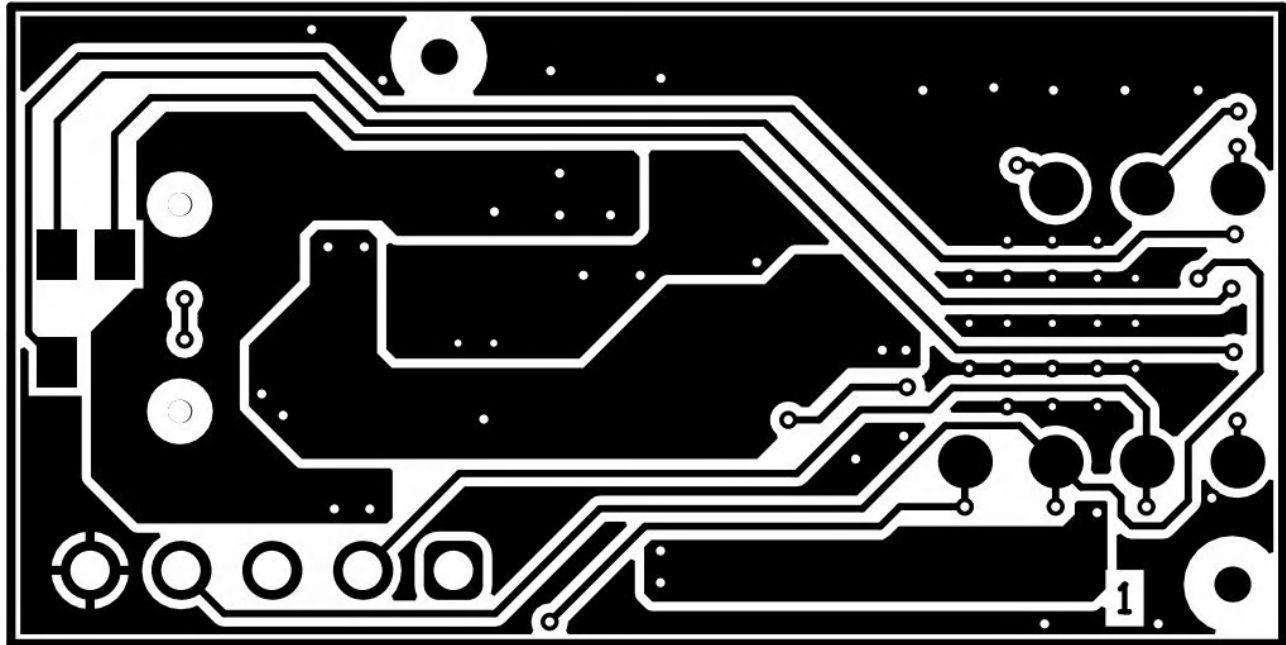


Figure 4-7. PCB Top Layer

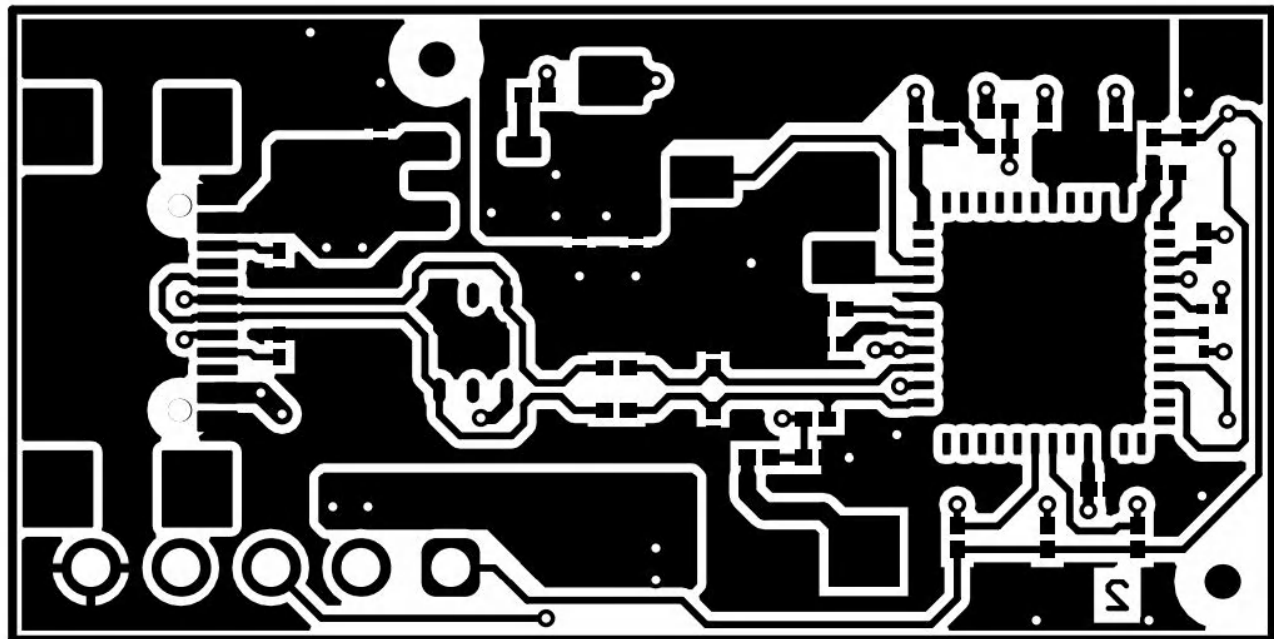


Figure 4-8. PCB Bottom Layer

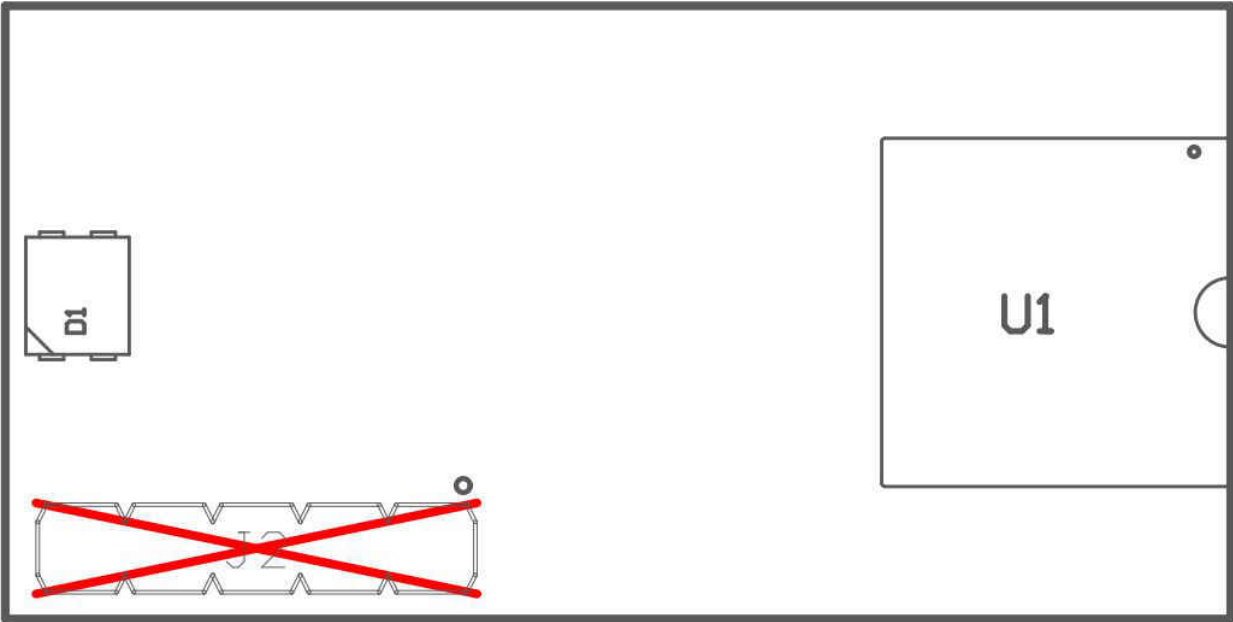


Figure 4-9. PCB Top-Layer Assembly Drawing

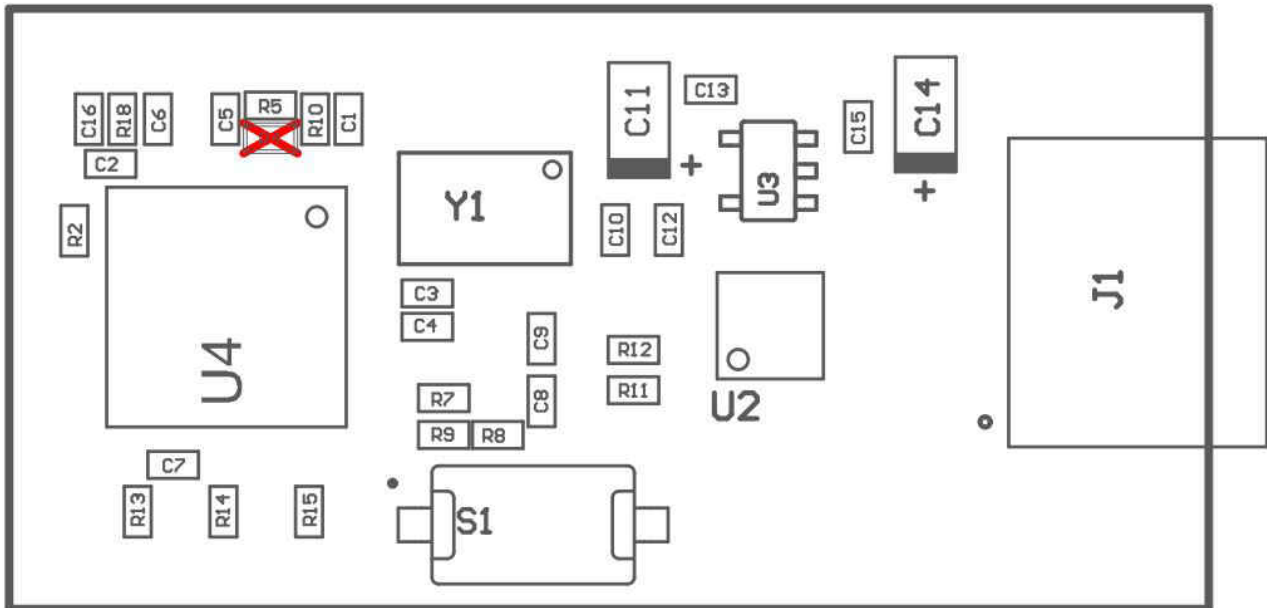


Figure 4-10. PCB Bottom-Layer Assembly Drawing

### 4.2.3 Bill of Materials

Table 4-2 lists the bill of materials for the OPTMBEVM motherboard.

**Table 4-2. OPTMBEVM Bill of Materials**

Designator	Quantity	Description	PartNumber	Manufacturer
C1	1	CAP, CERM, 1 uF, 10 V, +/- 10%, X7S, AEC-Q200 Grade 1, 0402	GCM155C71A105KE38D	MuRata
J1, J2, J3, J4, J5, J6, J7, J8	8	PC Pin Terminal Connector Through Hole Gold 0.017" (0.43mm) Dia	3121-2-00-15-00-00-08-0	Mill-Max
R2	1	RES, 620, 5%, 0.05 W, 0201	RC0201JR-07620RL	Yageo America
R5, R18	2	RES, 0, 5%, .05 W, AEC-Q200 Grade 0, 0201	ERJ-1GN0R00C	Panasonic
R7	1	RES, 1.5 k, 5%, 0.05 W, 0201	RC0201JR-071K5L	Yageo America
R8	1	RES, 100, 1%, 0.05 W, 0201	ERJ-1GEF1000C	Panasonic
R9	1	RES, 1.00 M, 1%, 0.05 W, AEC-Q200 Grade 0, 0201	RK73H1HTTC1004F	KOA Speer
R10	1	RES, 47 k, 5%, 0.05 W, 0201	RC0201JR-0747KL	Yageo America
R11, R12	2	RES, 27, 5%, 0.05 W, 0201	RC0201JR-0727RL	Yageo America
R13, R14, R15	3	RES, 4.7 k, 5%, 0.05 W, 0201	RC0201JR-074K7L	Yageo America
R16, R17	2	RES SMD 5.1K OHM 5% 1/20W 0201	CRCW02015K10JNED	Vishay Dale
S1	1	Switch, Tactile, SPST-NO, 0.05A, 12V, SMD	RS-032G05A3-SM RT	C&K Components
U1	1	Socket, DIP-8, 2.54 mm Pitch, SMT	114-87-308-41-134161	Preci-Dip
U2	1	Low-Capacitance + / - 15 kV ESD-Protection Array for High-Speed Data Interfaces, 2 Channels, -40 to +85 degC, 6-pin SON (DRS), Green (RoHS & no Sb/Br)	TPD2E001DRST-NM	Texas Instruments
U3	1	Single Output Low Noise LDO, 400 mA, Fixed 3.3 V Output, 1.7 to 5.5 V Input, with Reverse Current Protection, 5-pin SOT-23 (DBV), -40 to 85 degC, Green (RoHS & no Sb/Br)	TPS73633DBVT	Texas Instruments
U4	1	Mixed Signal Microcontroller, RGZ0048A (VQFN-48)	MSP430F5503IRGZR	Texas Instruments
Y1	1	Crystal, 24 MHz, 10 pF, SMD	ABM3B-24.000MHZ-10-1-U-T	Abracorn Corporation
FID1, FID2, FID3, FID4	0	Fiducial mark. There is nothing to buy or mount.	N/A	N/A
J2	0	Header, 2.54mm, 5x1, Gold, TH	61300511121	Würth Elektronik
R4	0	RES, 0, 5%, .05 W, AEC-Q200 Grade 0, 0201	ERJ-1GN0R00C	Panasonic

## 5 Troubleshooting

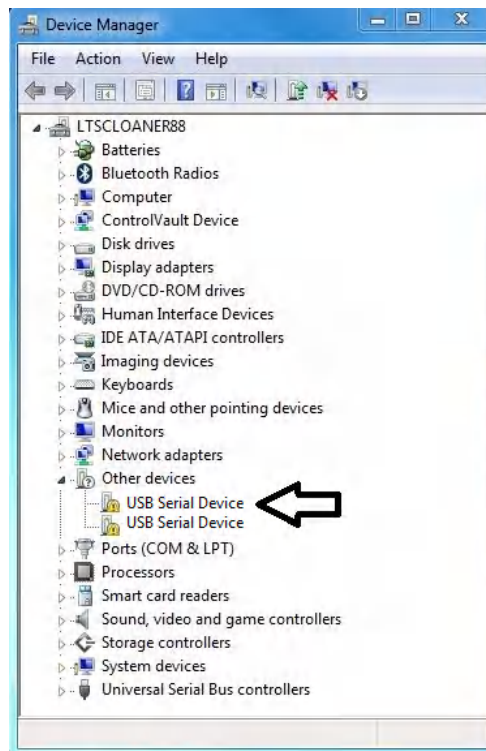
### 5.1 Microsoft Windows 7 Manual Driver Installation

This section outlines the manual driver installation process. If you are using Windows 7 or if the Windows device manager shows 2 USB Serial Devices under as *other devices* when the EVM is plugged in instead of COM ports as shown in [Figure 5-1](#), then use the following steps. If two *USB Serial Device* devices show up as COM ports automatically (as is the case with Windows 10), then this section can be skipped.



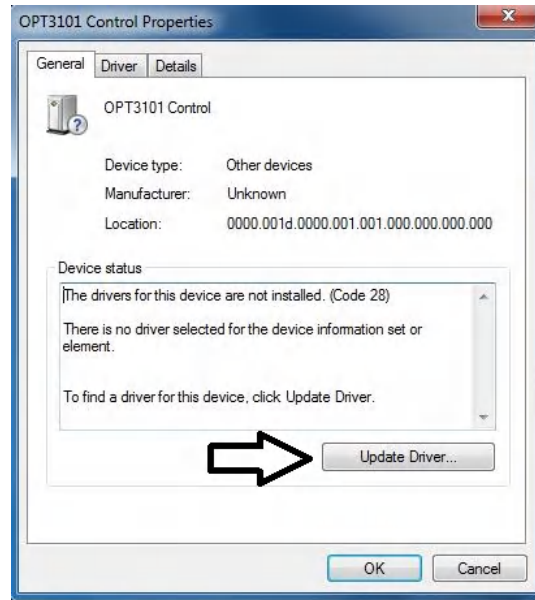
**Figure 5-1. OPTEVM on Microsoft® Windows® 7 With Drivers not Installed**

1. Open the device manager.

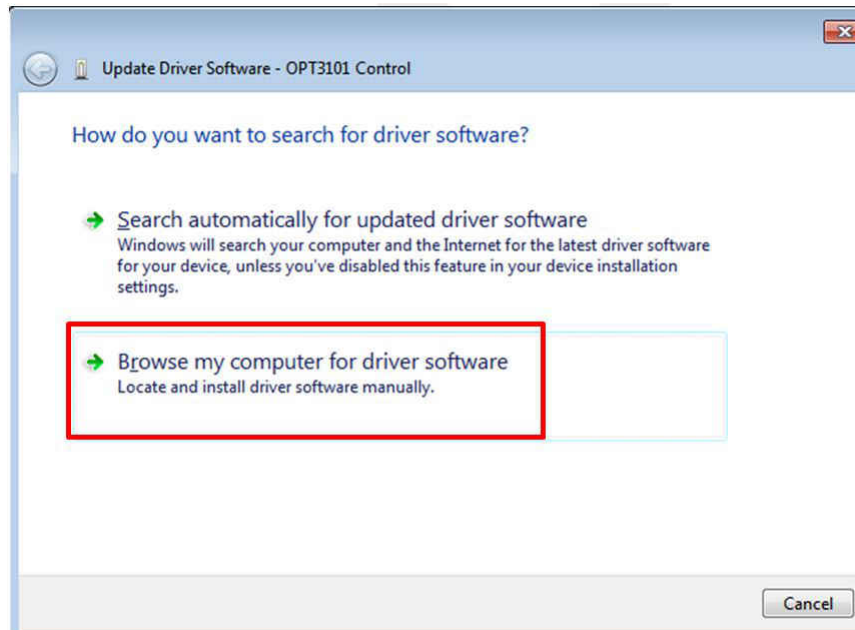


2. Right click on *USB Serial Device* and select Properties.

3. Click the **Update Driver** button.

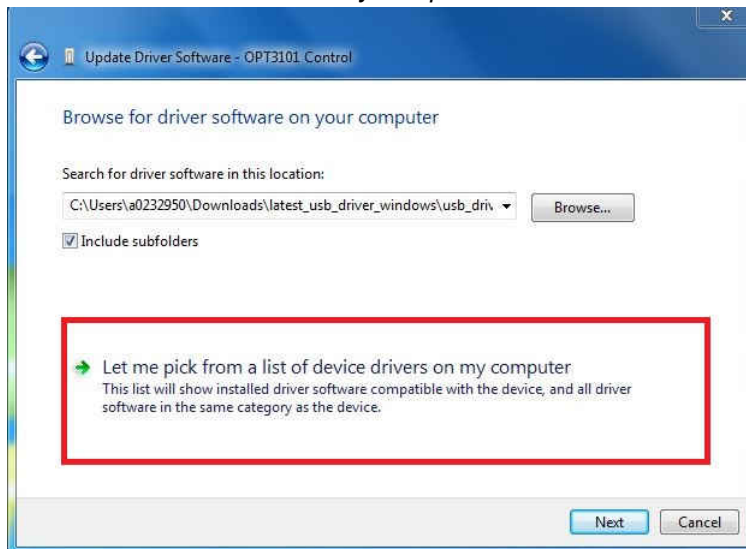


4. Click *Browse my computer for driver software*

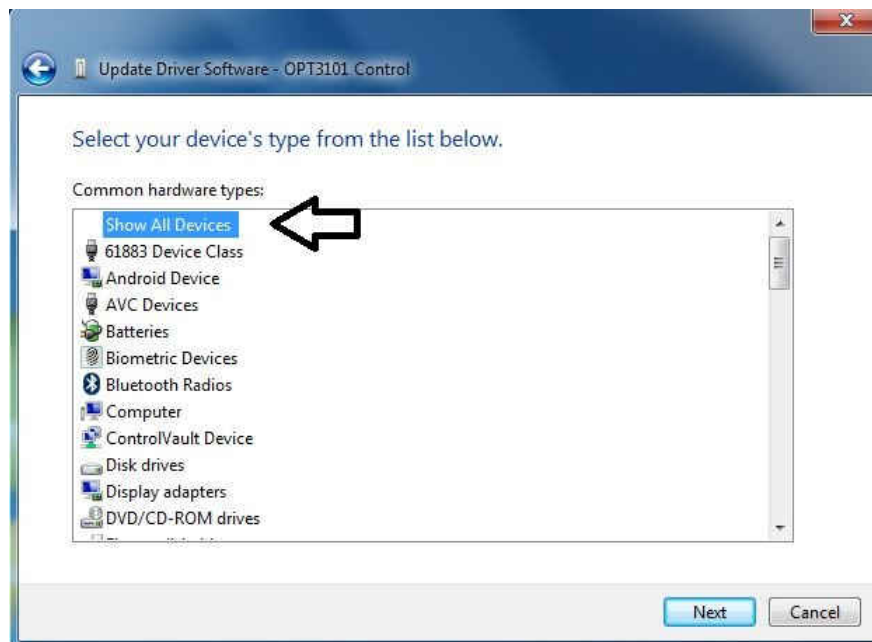




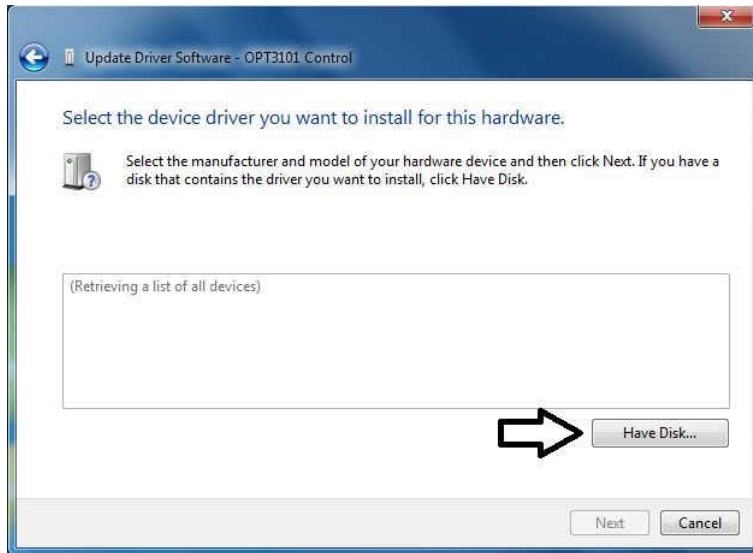
5. Click *Let me pick from a list of device drivers on my computer*.



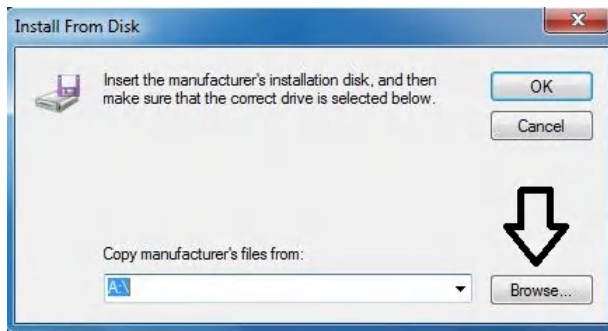
6. Select *Show All Devices* and click the **Next** button.



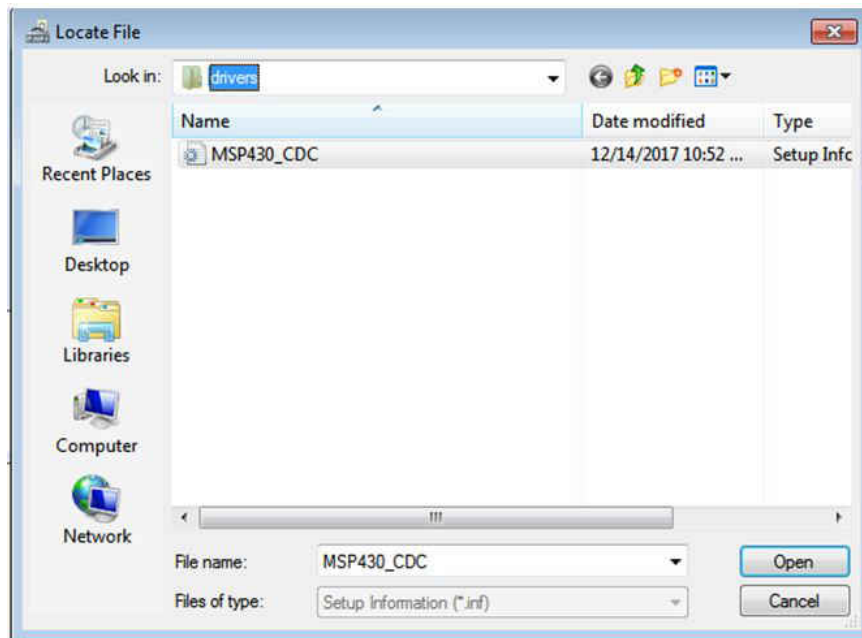
- Click the **Have Disk** button.



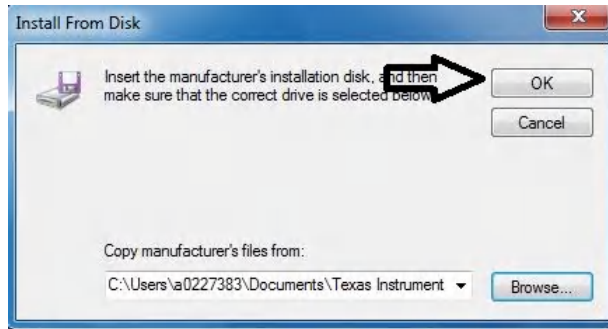
- Click the **Browse** button.



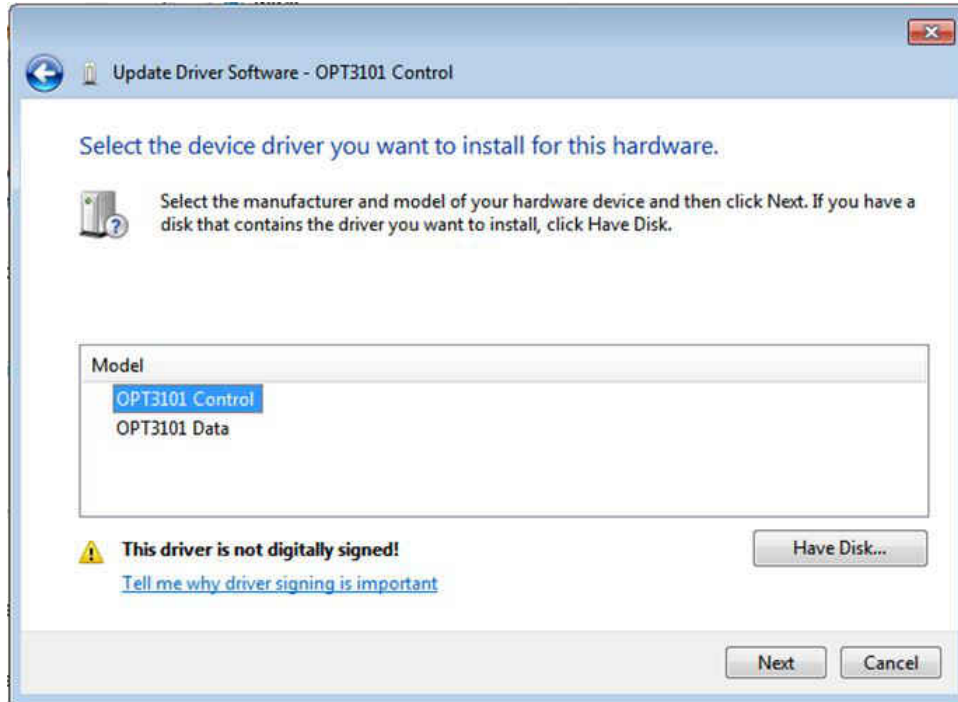
- Navigate to "C:\Users\\Documents\Texas Instruments\Latte\projects\OPT3004\drivers" and choose MSP430\_CDC. Click the **Open** button.



10. Click the **OK** button



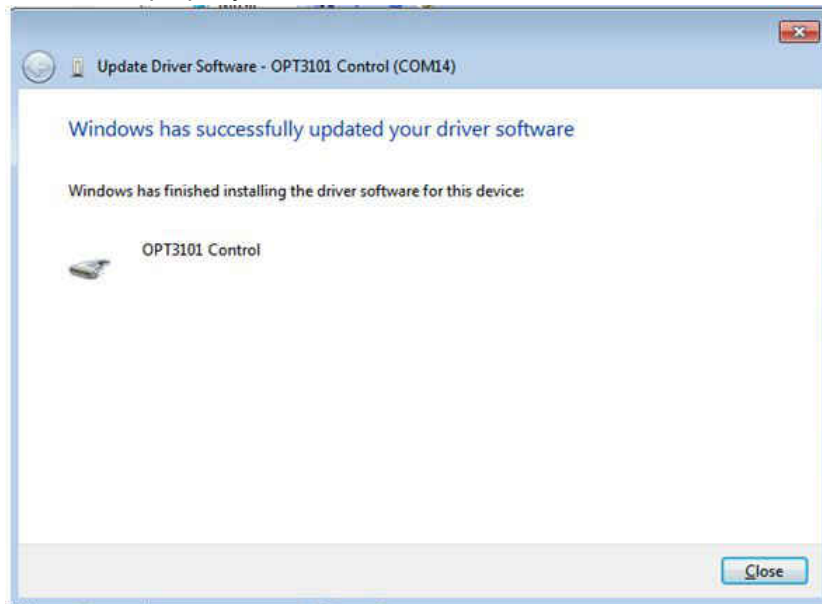
11. Select the first *USB serial device* and click the **Next** button.



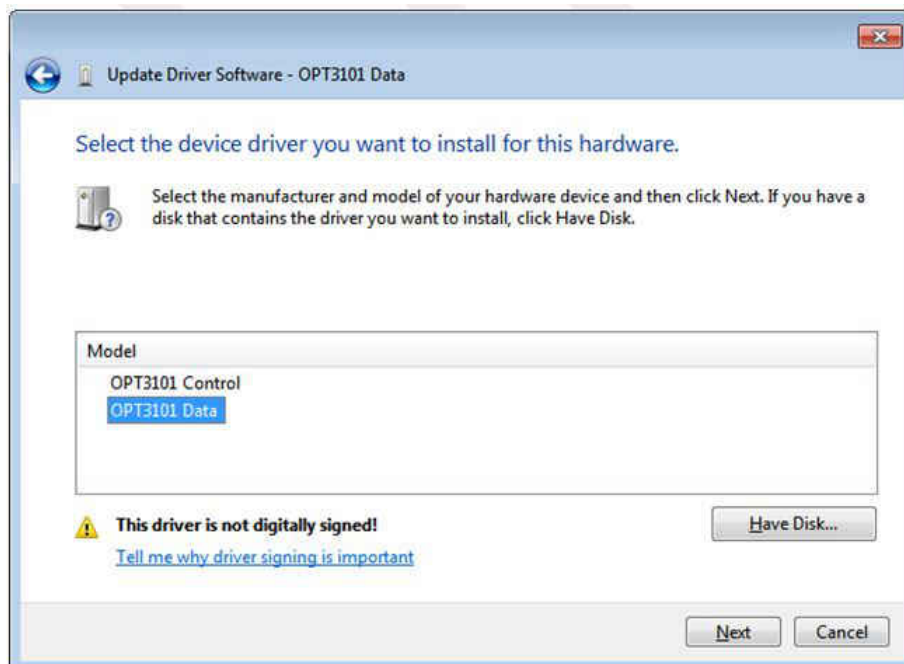
12. Click the **Yes** button.



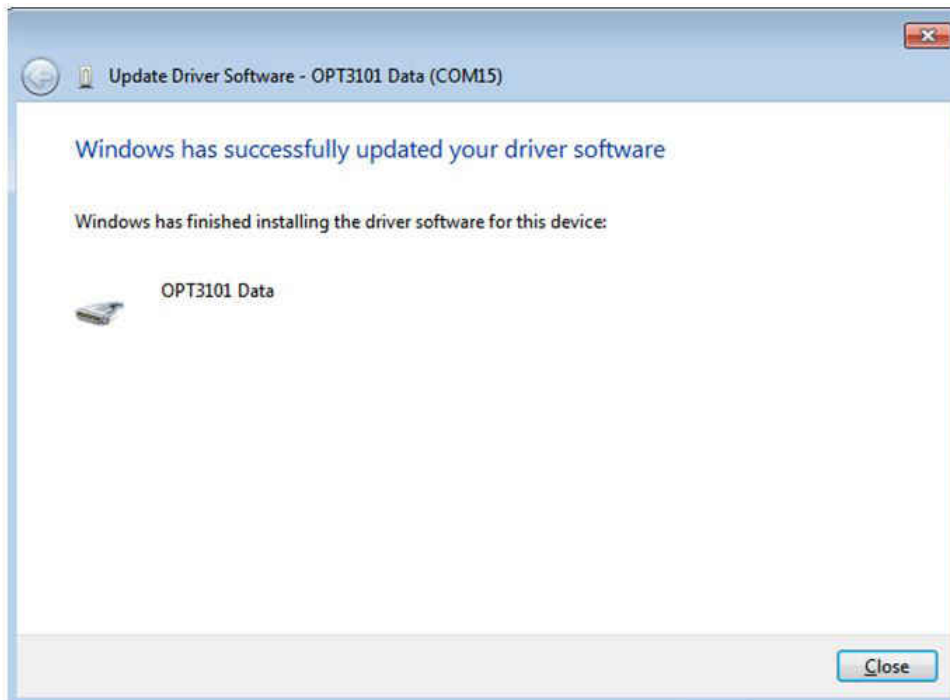
13. The driver should now install properly.



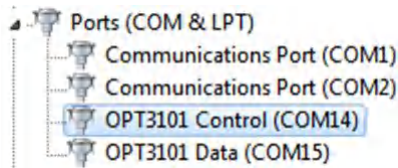
14. Now repeat this process (steps 1 to 13) for the second *USB Serial Device*. All steps are the same except for step 2 and step 11. In step 2 make sure to right click the second *USB Serial Device*. Likewise, on step 11 make sure to select the second *USB Serial Device* when installing the driver as the following figure shows.



15. When the driver is installed, you will see the following message.



16. The two *USB Serial Device* devices should now appear in the device manager under Ports (COM & LPT) as the following image shows.



## STANDARD TERMS FOR EVALUATION MODULES

1. *Delivery:* TI delivers TI evaluation boards, kits, or modules, including any accompanying demonstration software, components, and/or documentation which may be provided together or separately (collectively, an "EVM" or "EVMs") to the User ("User") in accordance with the terms set forth herein. User's acceptance of the EVM is expressly subject to the following terms.
  - 1.1 EVMs are intended solely for product or software developers for use in a research and development setting to facilitate feasibility evaluation, experimentation, or scientific analysis of TI semiconductors products. EVMs have no direct function and are not finished products. EVMs shall not be directly or indirectly assembled as a part or subassembly in any finished product. For clarification, any software or software tools provided with the EVM ("Software") shall not be subject to the terms and conditions set forth herein but rather shall be subject to the applicable terms that accompany such Software
  - 1.2 EVMs are not intended for consumer or household use. EVMs may not be sold, sublicensed, leased, rented, loaned, assigned, or otherwise distributed for commercial purposes by Users, in whole or in part, or used in any finished product or production system.
2. *Limited Warranty and Related Remedies/Disclaimers:*
  - 2.1 These terms do not apply to Software. The warranty, if any, for Software is covered in the applicable Software License Agreement.
  - 2.2 TI warrants that the TI EVM will conform to TI's published specifications for ninety (90) days after the date TI delivers such EVM to User. Notwithstanding the foregoing, TI shall not be liable for a nonconforming EVM if (a) the nonconformity was caused by neglect, misuse or mistreatment by an entity other than TI, including improper installation or testing, or for any EVMs that have been altered or modified in any way by an entity other than TI, (b) the nonconformity resulted from User's design, specifications or instructions for such EVMs or improper system design, or (c) User has not paid on time. Testing and other quality control techniques are used to the extent TI deems necessary. TI does not test all parameters of each EVM. User's claims against TI under this Section 2 are void if User fails to notify TI of any apparent defects in the EVMs within ten (10) business days after delivery, or of any hidden defects with ten (10) business days after the defect has been detected.
  - 2.3 TI's sole liability shall be at its option to repair or replace EVMs that fail to conform to the warranty set forth above, or credit User's account for such EVM. TI's liability under this warranty shall be limited to EVMs that are returned during the warranty period to the address designated by TI and that are determined by TI not to conform to such warranty. If TI elects to repair or replace such EVM, TI shall have a reasonable time to repair such EVM or provide replacements. Repaired EVMs shall be warranted for the remainder of the original warranty period. Replaced EVMs shall be warranted for a new full ninety (90) day warranty period.

### **WARNING**

**Evaluation Kits are intended solely for use by technically qualified, professional electronics experts who are familiar with the dangers and application risks associated with handling electrical mechanical components, systems, and subsystems.**

**User shall operate the Evaluation Kit within TI's recommended guidelines and any applicable legal or environmental requirements as well as reasonable and customary safeguards. Failure to set up and/or operate the Evaluation Kit within TI's recommended guidelines may result in personal injury or death or property damage. Proper set up entails following TI's instructions for electrical ratings of interface circuits such as input, output and electrical loads.**

**NOTE:**

**EXPOSURE TO ELECTROSTATIC DISCHARGE (ESD) MAY CAUSE DEGRADATION OR FAILURE OF THE EVALUATION KIT; TI RECOMMENDS STORAGE OF THE EVALUATION KIT IN A PROTECTIVE ESD BAG.**

### 3 Regulatory Notices:

#### 3.1 United States

##### 3.1.1 Notice applicable to EVMs not FCC-Approved:

**FCC NOTICE:** This kit is designed to allow product developers to evaluate electronic components, circuitry, or software associated with the kit to determine whether to incorporate such items in a finished product and software developers to write software applications for use with the end product. This kit is not a finished product and when assembled may not be resold or otherwise marketed unless all required FCC equipment authorizations are first obtained. Operation is subject to the condition that this product not cause harmful interference to licensed radio stations and that this product accept harmful interference. Unless the assembled kit is designed to operate under part 15, part 18 or part 95 of this chapter, the operator of the kit must operate under the authority of an FCC license holder or must secure an experimental authorization under part 5 of this chapter.

##### 3.1.2 For EVMs annotated as FCC – FEDERAL COMMUNICATIONS COMMISSION Part 15 Compliant:

#### **CAUTION**

This device complies with part 15 of the FCC Rules. Operation is subject to the following two conditions: (1) This device may not cause harmful interference, and (2) this device must accept any interference received, including interference that may cause undesired operation.

Changes or modifications not expressly approved by the party responsible for compliance could void the user's authority to operate the equipment.

#### **FCC Interference Statement for Class A EVM devices**

*NOTE: This equipment has been tested and found to comply with the limits for a Class A digital device, pursuant to part 15 of the FCC Rules. These limits are designed to provide reasonable protection against harmful interference when the equipment is operated in a commercial environment. This equipment generates, uses, and can radiate radio frequency energy and, if not installed and used in accordance with the instruction manual, may cause harmful interference to radio communications. Operation of this equipment in a residential area is likely to cause harmful interference in which case the user will be required to correct the interference at his own expense.*

#### **FCC Interference Statement for Class B EVM devices**

*NOTE: This equipment has been tested and found to comply with the limits for a Class B digital device, pursuant to part 15 of the FCC Rules. These limits are designed to provide reasonable protection against harmful interference in a residential installation. This equipment generates, uses and can radiate radio frequency energy and, if not installed and used in accordance with the instructions, may cause harmful interference to radio communications. However, there is no guarantee that interference will not occur in a particular installation. If this equipment does cause harmful interference to radio or television reception, which can be determined by turning the equipment off and on, the user is encouraged to try to correct the interference by one or more of the following measures:*

- Reorient or relocate the receiving antenna.
- Increase the separation between the equipment and receiver.
- Connect the equipment into an outlet on a circuit different from that to which the receiver is connected.
- Consult the dealer or an experienced radio/TV technician for help.

#### 3.2 Canada

##### 3.2.1 For EVMs issued with an Industry Canada Certificate of Conformance to RSS-210 or RSS-247

#### **Concerning EVMs Including Radio Transmitters:**

This device complies with Industry Canada license-exempt RSSs. Operation is subject to the following two conditions:

(1) this device may not cause interference, and (2) this device must accept any interference, including interference that may cause undesired operation of the device.

#### **Concernant les EVMs avec appareils radio:**

Le présent appareil est conforme aux CNR d'Industrie Canada applicables aux appareils radio exempts de licence. L'exploitation est autorisée aux deux conditions suivantes: (1) l'appareil ne doit pas produire de brouillage, et (2) l'utilisateur de l'appareil doit accepter tout brouillage radioélectrique subi, même si le brouillage est susceptible d'en compromettre le fonctionnement.

#### **Concerning EVMs Including Detachable Antennas:**

Under Industry Canada regulations, this radio transmitter may only operate using an antenna of a type and maximum (or lesser) gain approved for the transmitter by Industry Canada. To reduce potential radio interference to other users, the antenna type and its gain should be so chosen that the equivalent isotropically radiated power (e.i.r.p.) is not more than that necessary for successful communication. This radio transmitter has been approved by Industry Canada to operate with the antenna types listed in the user guide with the maximum permissible gain and required antenna impedance for each antenna type indicated. Antenna types not included in this list, having a gain greater than the maximum gain indicated for that type, are strictly prohibited for use with this device.



### Concernant les EVMs avec antennes détachables

Conformément à la réglementation d'Industrie Canada, le présent émetteur radio peut fonctionner avec une antenne d'un type et d'un gain maximal (ou inférieur) approuvé pour l'émetteur par Industrie Canada. Dans le but de réduire les risques de brouillage radioélectrique à l'intention des autres utilisateurs, il faut choisir le type d'antenne et son gain de sorte que la puissance isotrope rayonnée équivalente (p.i.r.e.) ne dépasse pas l'intensité nécessaire à l'établissement d'une communication satisfaisante. Le présent émetteur radio a été approuvé par Industrie Canada pour fonctionner avec les types d'antenne énumérés dans le manuel d'usage et ayant un gain admissible maximal et l'impédance requise pour chaque type d'antenne. Les types d'antenne non inclus dans cette liste, ou dont le gain est supérieur au gain maximal indiqué, sont strictement interdits pour l'exploitation de l'émetteur.

#### 3.3 Japan

3.3.1 *Notice for EVMs delivered in Japan:* Please see [http://www.tij.co.jp/lstds/ti\\_ja/general/eStore/notice\\_01.page](http://www.tij.co.jp/lstds/ti_ja/general/eStore/notice_01.page) 日本国内に輸入される評価用キット、ボードについては、次のところをご覧ください。  
[http://www.tij.co.jp/lstds/ti\\_ja/general/eStore/notice\\_01.page](http://www.tij.co.jp/lstds/ti_ja/general/eStore/notice_01.page)

3.3.2 *Notice for Users of EVMs Considered "Radio Frequency Products" in Japan:* EVMs entering Japan may not be certified by TI as conforming to Technical Regulations of Radio Law of Japan.

If User uses EVMs in Japan, not certified to Technical Regulations of Radio Law of Japan, User is required to follow the instructions set forth by Radio Law of Japan, which includes, but is not limited to, the instructions below with respect to EVMs (which for the avoidance of doubt are stated strictly for convenience and should be verified by User):

1. Use EVMs in a shielded room or any other test facility as defined in the notification #173 issued by Ministry of Internal Affairs and Communications on March 28, 2006, based on Sub-section 1.1 of Article 6 of the Ministry's Rule for Enforcement of Radio Law of Japan,
2. Use EVMs only after User obtains the license of Test Radio Station as provided in Radio Law of Japan with respect to EVMs, or
3. Use of EVMs only after User obtains the Technical Regulations Conformity Certification as provided in Radio Law of Japan with respect to EVMs. Also, do not transfer EVMs, unless User gives the same notice above to the transferee. Please note that if User does not follow the instructions above, User will be subject to penalties of Radio Law of Japan.

【無線電波を送信する製品の開発キットをお使いになる際の注意事項】 開発キットの中には技術基準適合証明を受けていないものがあります。技術適合証明を受けていないものご使用に際しては、電波法遵守のため、以下のいずれかの措置を取っていただく必要がありますのでご注意ください。

1. 電波法施行規則第6条第1項第1号に基づく平成18年3月28日総務省告示第173号で定められた電波暗室等の試験設備でご使用いただく。
2. 実験局の免許を取得後ご使用いただく。
3. 技術基準適合証明を取得後ご使用いただく。

なお、本製品は、上記の「ご使用にあたっての注意」を譲渡先、移転先に通知しない限り、譲渡、移転できないものとします。

上記を遵守頂けない場合は、電波法の罰則が適用される可能性があることをご留意ください。日本テキサス・インスツルメンツ株式会社  
東京都新宿区西新宿 6 丁目 2 4 番 1 号  
西新宿三井ビル

3.3.3 *Notice for EVMs for Power Line Communication:* Please see [http://www.tij.co.jp/lstds/ti\\_ja/general/eStore/notice\\_02.page](http://www.tij.co.jp/lstds/ti_ja/general/eStore/notice_02.page)  
電力線搬送波通信についての開発キットをお使いになる際の注意事項については、次のところをご覧ください。[http://www.tij.co.jp/lstds/ti\\_ja/general/eStore/notice\\_02.page](http://www.tij.co.jp/lstds/ti_ja/general/eStore/notice_02.page)

#### 3.4 European Union

3.4.1 *For EVMs subject to EU Directive 2014/30/EU (Electromagnetic Compatibility Directive):*

This is a class A product intended for use in environments other than domestic environments that are connected to a low-voltage power-supply network that supplies buildings used for domestic purposes. In a domestic environment this product may cause radio interference in which case the user may be required to take adequate measures.

- 
- 4 *EVM Use Restrictions and Warnings:*
    - 4.1 EVMS ARE NOT FOR USE IN FUNCTIONAL SAFETY AND/OR SAFETY CRITICAL EVALUATIONS, INCLUDING BUT NOT LIMITED TO EVALUATIONS OF LIFE SUPPORT APPLICATIONS.
    - 4.2 User must read and apply the user guide and other available documentation provided by TI regarding the EVM prior to handling or using the EVM, including without limitation any warning or restriction notices. The notices contain important safety information related to, for example, temperatures and voltages.
    - 4.3 *Safety-Related Warnings and Restrictions:*
      - 4.3.1 User shall operate the EVM within TI's recommended specifications and environmental considerations stated in the user guide, other available documentation provided by TI, and any other applicable requirements and employ reasonable and customary safeguards. Exceeding the specified performance ratings and specifications (including but not limited to input and output voltage, current, power, and environmental ranges) for the EVM may cause personal injury or death, or property damage. If there are questions concerning performance ratings and specifications, User should contact a TI field representative prior to connecting interface electronics including input power and intended loads. Any loads applied outside of the specified output range may also result in unintended and/or inaccurate operation and/or possible permanent damage to the EVM and/or interface electronics. Please consult the EVM user guide prior to connecting any load to the EVM output. If there is uncertainty as to the load specification, please contact a TI field representative. During normal operation, even with the inputs and outputs kept within the specified allowable ranges, some circuit components may have elevated case temperatures. These components include but are not limited to linear regulators, switching transistors, pass transistors, current sense resistors, and heat sinks, which can be identified using the information in the associated documentation. When working with the EVM, please be aware that the EVM may become very warm.
      - 4.3.2 EVMs are intended solely for use by technically qualified, professional electronics experts who are familiar with the dangers and application risks associated with handling electrical mechanical components, systems, and subsystems. User assumes all responsibility and liability for proper and safe handling and use of the EVM by User or its employees, affiliates, contractors or designees. User assumes all responsibility and liability to ensure that any interfaces (electronic and/or mechanical) between the EVM and any human body are designed with suitable isolation and means to safely limit accessible leakage currents to minimize the risk of electrical shock hazard. User assumes all responsibility and liability for any improper or unsafe handling or use of the EVM by User or its employees, affiliates, contractors or designees.
    - 4.4 User assumes all responsibility and liability to determine whether the EVM is subject to any applicable international, federal, state, or local laws and regulations related to User's handling and use of the EVM and, if applicable, User assumes all responsibility and liability for compliance in all respects with such laws and regulations. User assumes all responsibility and liability for proper disposal and recycling of the EVM consistent with all applicable international, federal, state, and local requirements.
  5. *Accuracy of Information:* To the extent TI provides information on the availability and function of EVMs, TI attempts to be as accurate as possible. However, TI does not warrant the accuracy of EVM descriptions, EVM availability or other information on its websites as accurate, complete, reliable, current, or error-free.
  6. *Disclaimers:*
    - 6.1 EXCEPT AS SET FORTH ABOVE, EVMS AND ANY MATERIALS PROVIDED WITH THE EVM (INCLUDING, BUT NOT LIMITED TO, REFERENCE DESIGNS AND THE DESIGN OF THE EVM ITSELF) ARE PROVIDED "AS IS" AND "WITH ALL FAULTS." TI DISCLAIMS ALL OTHER WARRANTIES, EXPRESS OR IMPLIED, REGARDING SUCH ITEMS, INCLUDING BUT NOT LIMITED TO ANY EPIDEMIC FAILURE WARRANTY OR IMPLIED WARRANTIES OF MERCHANTABILITY OR FITNESS FOR A PARTICULAR PURPOSE OR NON-INFRINGEMENT OF ANY THIRD PARTY PATENTS, COPYRIGHTS, TRADE SECRETS OR OTHER INTELLECTUAL PROPERTY RIGHTS.
    - 6.2 EXCEPT FOR THE LIMITED RIGHT TO USE THE EVM SET FORTH HEREIN, NOTHING IN THESE TERMS SHALL BE CONSTRUED AS GRANTING OR CONFERRING ANY RIGHTS BY LICENSE, PATENT, OR ANY OTHER INDUSTRIAL OR INTELLECTUAL PROPERTY RIGHT OF TI, ITS SUPPLIERS/LICENSORS OR ANY OTHER THIRD PARTY, TO USE THE EVM IN ANY FINISHED END-USER OR READY-TO-USE FINAL PRODUCT, OR FOR ANY INVENTION, DISCOVERY OR IMPROVEMENT, REGARDLESS OF WHEN MADE, CONCEIVED OR ACQUIRED.
  7. *USER'S INDEMNITY OBLIGATIONS AND REPRESENTATIONS.* USER WILL DEFEND, INDEMNIFY AND HOLD TI, ITS LICENSORS AND THEIR REPRESENTATIVES HARMLESS FROM AND AGAINST ANY AND ALL CLAIMS, DAMAGES, LOSSES, EXPENSES, COSTS AND LIABILITIES (COLLECTIVELY, "CLAIMS") ARISING OUT OF OR IN CONNECTION WITH ANY HANDLING OR USE OF THE EVM THAT IS NOT IN ACCORDANCE WITH THESE TERMS. THIS OBLIGATION SHALL APPLY WHETHER CLAIMS ARISE UNDER STATUTE, REGULATION, OR THE LAW OF TORT, CONTRACT OR ANY OTHER LEGAL THEORY, AND EVEN IF THE EVM FAILS TO PERFORM AS DESCRIBED OR EXPECTED.

8. *Limitations on Damages and Liability:*

8.1 *General Limitations.* IN NO EVENT SHALL TI BE LIABLE FOR ANY SPECIAL, COLLATERAL, INDIRECT, PUNITIVE, INCIDENTAL, CONSEQUENTIAL, OR EXEMPLARY DAMAGES IN CONNECTION WITH OR ARISING OUT OF THESE TERMS OR THE USE OF THE EVMS , REGARDLESS OF WHETHER TI HAS BEEN ADVISED OF THE POSSIBILITY OF SUCH DAMAGES. EXCLUDED DAMAGES INCLUDE, BUT ARE NOT LIMITED TO, COST OF REMOVAL OR REINSTALLATION, ANCILLARY COSTS TO THE PROCUREMENT OF SUBSTITUTE GOODS OR SERVICES, RETESTING, OUTSIDE COMPUTER TIME, LABOR COSTS, LOSS OF GOODWILL, LOSS OF PROFITS, LOSS OF SAVINGS, LOSS OF USE, LOSS OF DATA, OR BUSINESS INTERRUPTION. NO CLAIM, SUIT OR ACTION SHALL BE BROUGHT AGAINST TI MORE THAN TWELVE (12) MONTHS AFTER THE EVENT THAT GAVE RISE TO THE CAUSE OF ACTION HAS OCCURRED.

8.2 *Specific Limitations.* IN NO EVENT SHALL TI'S AGGREGATE LIABILITY FROM ANY USE OF AN EVM PROVIDED HEREUNDER, INCLUDING FROM ANY WARRANTY, INDEMNITY OR OTHER OBLIGATION ARISING OUT OF OR IN CONNECTION WITH THESE TERMS, , EXCEED THE TOTAL AMOUNT PAID TO TI BY USER FOR THE PARTICULAR EVM(S) AT ISSUE DURING THE PRIOR TWELVE (12) MONTHS WITH RESPECT TO WHICH LOSSES OR DAMAGES ARE CLAIMED. THE EXISTENCE OF MORE THAN ONE CLAIM SHALL NOT ENLARGE OR EXTEND THIS LIMIT.

9. *Return Policy.* Except as otherwise provided, TI does not offer any refunds, returns, or exchanges. Furthermore, no return of EVM(s) will be accepted if the package has been opened and no return of the EVM(s) will be accepted if they are damaged or otherwise not in a resalable condition. If User feels it has been incorrectly charged for the EVM(s) it ordered or that delivery violates the applicable order, User should contact TI. All refunds will be made in full within thirty (30) working days from the return of the components(s), excluding any postage or packaging costs.

10. *Governing Law:* These terms and conditions shall be governed by and interpreted in accordance with the laws of the State of Texas, without reference to conflict-of-laws principles. User agrees that non-exclusive jurisdiction for any dispute arising out of or relating to these terms and conditions lies within courts located in the State of Texas and consents to venue in Dallas County, Texas. Notwithstanding the foregoing, any judgment may be enforced in any United States or foreign court, and TI may seek injunctive relief in any United States or foreign court.

Mailing Address: Texas Instruments, Post Office Box 655303, Dallas, Texas 75265  
Copyright © 2019, Texas Instruments Incorporated

## IMPORTANT NOTICE AND DISCLAIMER

TI PROVIDES TECHNICAL AND RELIABILITY DATA (INCLUDING DATA SHEETS), DESIGN RESOURCES (INCLUDING REFERENCE DESIGNS), APPLICATION OR OTHER DESIGN ADVICE, WEB TOOLS, SAFETY INFORMATION, AND OTHER RESOURCES "AS IS" AND WITH ALL FAULTS, AND DISCLAIMS ALL WARRANTIES, EXPRESS AND IMPLIED, INCLUDING WITHOUT LIMITATION ANY IMPLIED WARRANTIES OF MERCHANTABILITY, FITNESS FOR A PARTICULAR PURPOSE OR NON-INFRINGEMENT OF THIRD PARTY INTELLECTUAL PROPERTY RIGHTS.

These resources are intended for skilled developers designing with TI products. You are solely responsible for (1) selecting the appropriate TI products for your application, (2) designing, validating and testing your application, and (3) ensuring your application meets applicable standards, and any other safety, security, regulatory or other requirements.

These resources are subject to change without notice. TI grants you permission to use these resources only for development of an application that uses the TI products described in the resource. Other reproduction and display of these resources is prohibited. No license is granted to any other TI intellectual property right or to any third party intellectual property right. TI disclaims responsibility for, and you will fully indemnify TI and its representatives against, any claims, damages, costs, losses, and liabilities arising out of your use of these resources.

TI's products are provided subject to [TI's Terms of Sale](#) or other applicable terms available either on [ti.com](http://ti.com) or provided in conjunction with such TI products. TI's provision of these resources does not expand or otherwise alter TI's applicable warranties or warranty disclaimers for TI products.

TI objects to and rejects any additional or different terms you may have proposed.

Mailing Address: Texas Instruments, Post Office Box 655303, Dallas, Texas 75265  
Copyright © 2022, Texas Instruments Incorporated