

ORCY-60U12x

Isolated DC-DC Converter

The ORCY-60U12x is part of the isolated DC/DC converters that operate from a wide input range (18 VDC - 75 VDC) and can cover both 24 Vin and 48 Vin input range.

These units will provide up to 84 W of output power. They are designed to be highly efficient and low cost. Features include remote on/off, over current protection, over voltage shut down, over temperature protection and under-voltage lockout.

These converters are provided in an industry standard 1/8 brick package.



Key Features & Benefits

- 18-75 VDC Input / 12 VDC @ 7 A Output
- 1/8th Brick Converter
- Isolated
- Fixed Frequency (258 kHz)
- High Efficiency
- High Power Density
- Input Under Voltage Lockout
- OCP/SCP
- Input Over-Voltage Lockout
- Over Temperature Protection
- Remote On/Off
- Output Over-Voltage Shutdown
- Positive/Negative Remote Sense
- Output Voltage Trim
- Basic Insulation
- Ultra Wide Input Range: 18 VDC - 75 VDC
- Low Cost
- Approved to UL/CSA 60950-1, 2nd +A2 version
- Class 2, Category 2, Isolated DC/DC Converter (refer to IPC-9592B)

Applications

- Networking
- Computers and Peripherals
- Telecommunications

1. I/O ASSIGNMENT SUMMARY

MODEL NUMBER	OUTPUT VOLTAGE	INPUT VOLTAGE	MAX. OUTPUT CURRENT	MAX. OUTPUT POWER	TYPICAL EFFICIENCY
ORCY-60U12L	12VDC	18 VDC – 75 VDC	7 A	84 W	92%
ORCY-60U120	12VDC	18 VDC – 75 VDC	7 A	84 W	92%
ORCY-60U12B	12VDC	18 VDC – 75 VDC	7 A	84 W	92%
ORCY-60U12W	12VDC	18 VDC – 75 VDC	7 A	84 W	92%

NOTE: Add “G” suffix at the end of the model number to indicate Tray Packaging.

PART NUMBER EXPLANATION

0	R	CY	-	60	U	12	x	G
Mounting Type	RoHS Status	Series Name		Output Power	Input Range	Output Voltage	Active Logic	Package Type
Through hole mount	RoHS	1/8 th Brick		84 W	18 – 75V	12 V	L-Active low, with baseplate B-Active low, open frame 0-Active high, with baseplate W-Active high, with baseplate	G – Tray package

2. ABSOLUTE MAXIMUM RATINGS

PARAMETER	DESCRIPTION	MIN	TYP	MAX	UNITS
Input Voltage (Continuous)		-0.3	-	80	V
Input Transient Voltage	100 ms maximum	-	-	100	V
Remote On/Off		-0.3	-	18	V
I/O Isolation Voltage		-	-	1500	V
Ambient Temperature		-40	-	85	°C
Altitude		-	-	2000	m
Storage Temperature		-55	-	125	°C

NOTE: Ratings used beyond the maximum ratings may cause a reliability degradation of the converter or may permanently damage the device.

3. INPUT SPECIFICATIONS

PARAMETER	DESCRIPTION	MIN	TYP	MAX	UNIT
Operating Input Voltage		18	24/48	75	V
Input Current (full load)	V _{in} =18 V	-	6.7	-	A
	V _{in} =75 V	-	1.6	-	A
Input Current (no load)		-	100	180	mA
Remote Off Input Current		-	20	30	mA
Input Reflected Ripple Current (rms)	Tested with simulated source impedance of 10 μH, 5 Hz to 20 MHz; use a 1 μF/100 V ceramic cap and a 100 μF/100 V electrolytic cap with ESR = 1 ohm max. at 200 kHz at 25 °C	-	7	10	mA
Input Reflected Ripple Current (pk-pk)		-	15	30	mA
I ² t Inrush Current Transient		-	0.05	0.1	A ² s
Turn-on Voltage Threshold		16	17	17.5	V
Turn-off Voltage Threshold		15	16	16.5	V
Input Over Voltage Lockout		76	78	80	V

CAUTION: This converter is not internally fused. An input line fuse must be used in application.

Recommend a fast-acting fuse with maximum rating of 8 A on system board. Refer to the fuse manufacture’s datasheet for further information.

NOTES: 1. This converter has internal C-L-C (2.2uH-2*0.47uF+2.2uF) filter.

2. All specifications are typical at 25 °C unless otherwise stated.

4. OUTPUT SPECIFICATIONS

PARAMETER	DESCRIPTION	MIN	TYP	MAX	UNIT
Output Voltage Set Point	V _{in} =48V, I _o =50% load.	11.76	12.0	12.24	V
Load Regulation		-	±6	±12	mV
Line Regulation		-	±10	±20	mV
Regulation Over Temperature (-40°C~ +85 °C)		-	±30	±50	mV
Ripple and Noise (pk-pk)	V _{in} =54V, I _o =100%load, 0-20MHz BW, with 3 * 22 μF ceramic capacitor at output	-	25	50	mV
Ripple and Noise (rms)		-	100	150	mV
Output Ripple and Noise (pk-pk) under worst case	0-20 MHz BW, with a 0.1 μF ceramic cap and a 10 μF tantalum cap at the output	-	-	150	mV
Output Current Range		0	-	7	A
Output DC Current Limit	V _{in} =48 V, in Hiccup Mode	7.7	-	11	A
Short Circuit Surge Transient		-	3	5	A ² s
Rise time		5	10	15	ms
Turn on Time	T _{on} (Enable from V _{in})	-	20	25	ms
	T _{on} (Enable from ON/OFF)	-	20	25	ms
Overshoot at Turn on		-	0	3	%
Output Capacitance		0	-	1000	μF
Transient Response					
ΔV 75%~50% of Max Load		-	300	400	mV
Settling Time	di/dt=0.1 A/μs, V _{in} =24 VDC, T _a =25 °C, with a 0.1 μF ceramic cap and a 10 μF tantalum cap at output	-	400	600	μs
ΔV 50%~75% of Max Load		-	300	400	mV
Settling Time		-	400	600	μs

NOTE: All specifications are typical at nominal input, full load at 25°C unless otherwise stated.



Asia-Pacific
+86 755 298 85888

Europe, Middle East
+353 61 225 977

North America
+1 408 785 5200

5. GENERAL SPECIFICATIONS

PARAMETER	DESCRIPTION	MIN	TYP	MAX	UNIT
Efficiency	Vin=24 V	90	91.5	-	%
	Vin=48 V	90.5	92	-	%
Switching Frequency		240	258	280	kHz
Isolation Capacitance		-	1500	-	pF
Remote Sense Compensation	The total voltage increased by trim and remote sense should not exceed 15%Vo	-	-	10	%
Output Voltage Trim Range		80	-	110	%
Over Temperature Protection		-	125	-	°C
Output Over Voltage Protection	Vin=48 V, full load, in Hiccup mode.	-	-	13.8	V
Weight		-	31.2	-	g
MTBF	Calculated Per Bell Core SR-332 (Vo=12V, Io=80%load, Ta = 25 °C)	-	1,867,232	-	Mhrs
Dimensions (L x W x H)	ORCY-60U120 & ORCY-60U12L&	2.30 x 0.896 x 0.49			inch
	ORCY-60U12W	58.42 x 22.76 x 12.47			mm
Dimensions (L x W x H)	ORCY-60U12B	2.30 x 0.900 x 0.45			inch
		58.42 x 22.86 x 11.5			mm

6. EFFICIENCY DATA

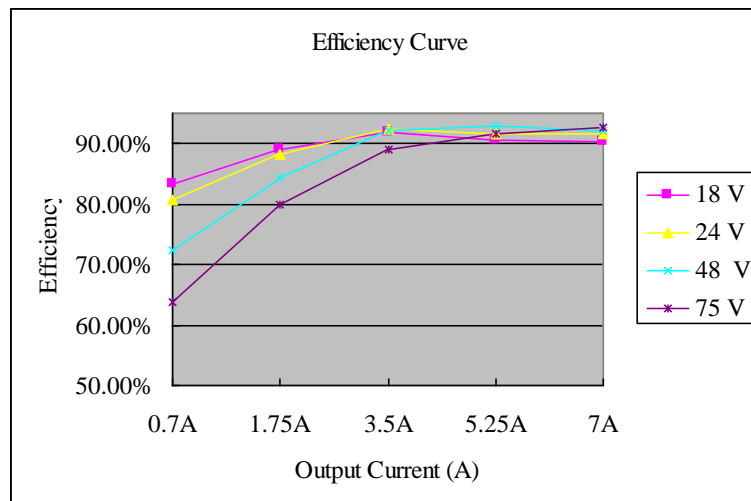

7. REMOTE ON/OFF

PARAMETER		DESCRIPTION	MIN	TYP	MAX	UNIT
Signal Low (Unit On)	Active Low	0RCY-60U12L & 0RCY-60U12B The remote on/off pin open, Unit off	-0.3	-	0.8	V
Signal High (Unit Off)			2.4	-	18	V
Signal Low (Unit On)	Active High	0RCY-60U120 & 0RCY-60U12W The remote on/off pin open, Unit on	-0.3	-	0.8	V
Signal High (Unit Off)			2.4	-	18	V
Current Sink			0	-	0.75	mA

Recommended remote on/off circuit for active low

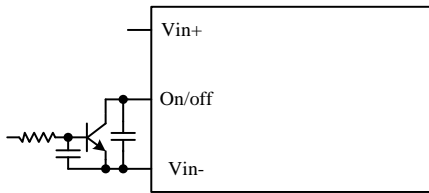

Control with open collector/drain circuit

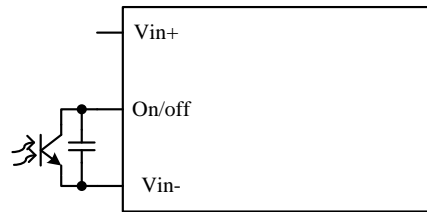

Control with photocoupler circuit

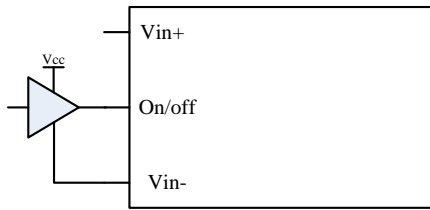

Control with logic circuit

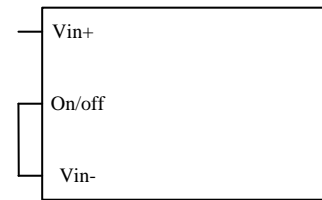

Permanently on

Recommended remote on/off circuit for active high

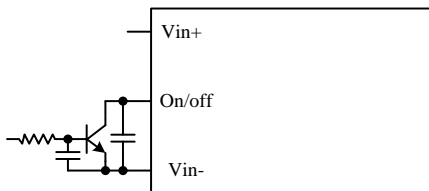

Control with open collector/drain circuit

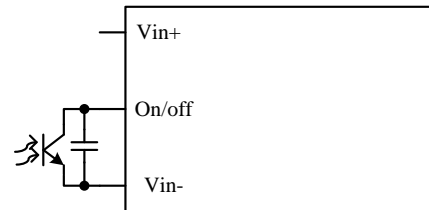

Control with photocoupler circuit

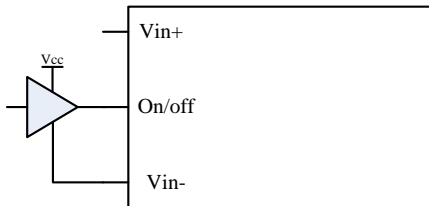

Control with logic circuit

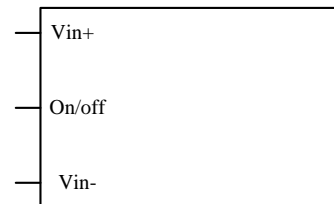

Permanently on

8. OUTPUT TRIM EQUATIONS

Equations for calculating the trim resistor are shown below. The Trim Down resistor should be connected between the Trim pin and GND pin. The Trim Up resistor should be connected between the Trim pin and the Vout pin. Only one of the resistors should be used for any given application.

$$R_{trimdown} = \frac{511}{|\delta|} - 10.22 [k\Omega]$$

$$R_{trimup} = \frac{(100 + \delta) \cdot V_o \cdot 5.11 - 626}{1.225 \cdot \delta} - 10.22 [k\Omega]$$

NOTE:

$$\delta = \frac{(V_o - req - V_o)}{V_o} \times 100 [\%]$$

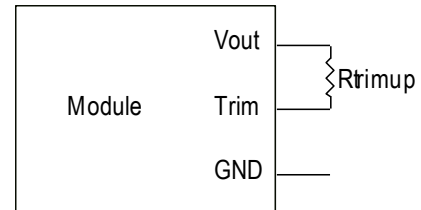
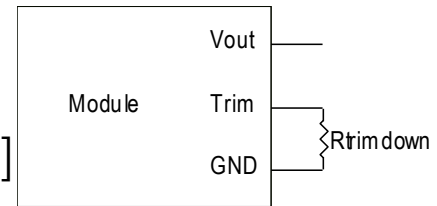

9. RIPPLE AND NOISE WAVEFORM

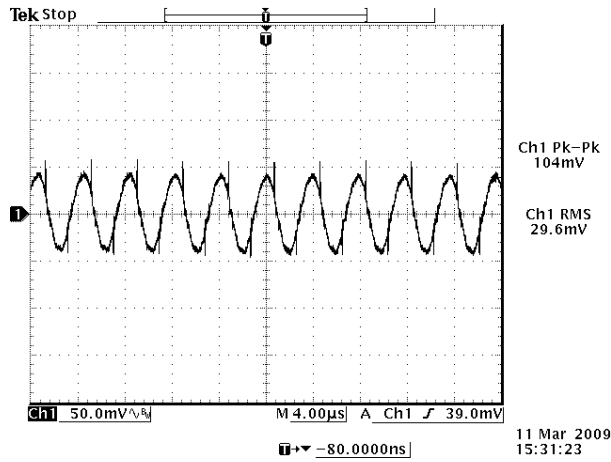

24 VDC input, 12 VDC/7 A output

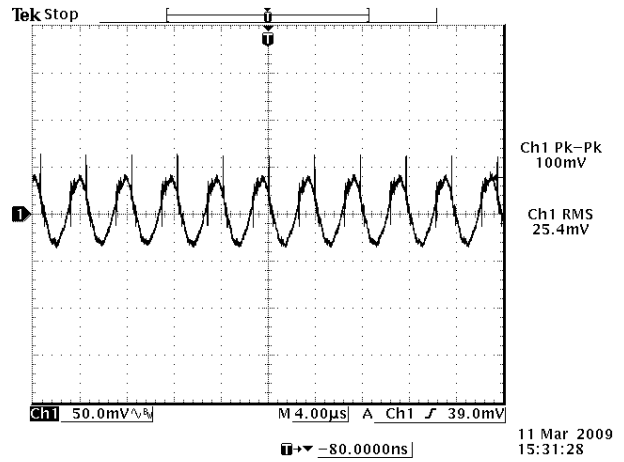

48 VDC input, 12 VDC/7 A output

Note: Ripple and noise at full load, 0-20 MHz BW, with a 0.1 µF ceramic cap and a 10 µF tantalum cap at the output, and Ta=25 °C.

10. NSIENT RESPONSE WAVEFORMS

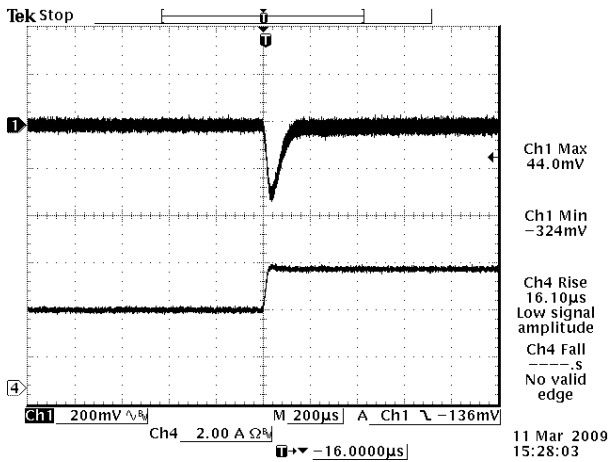

50%-75% Load Transients at $V_{in}=24$ V

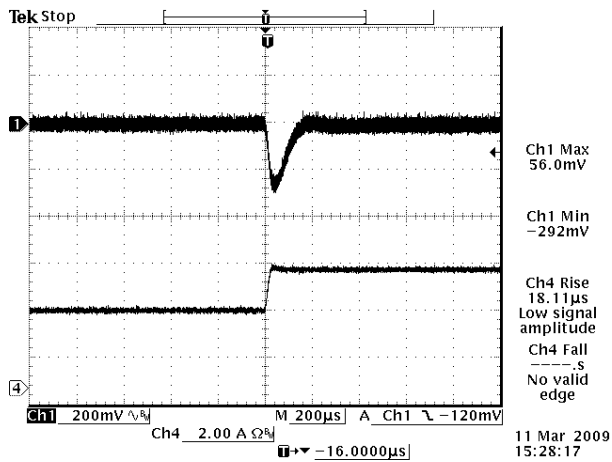

50%-75% Load Transients at $V_{in}=24$ V

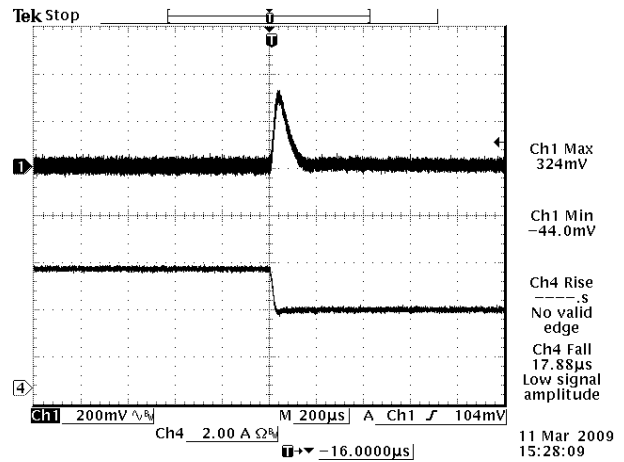

75%-50% Load Transients at $V_{in}=48$ V

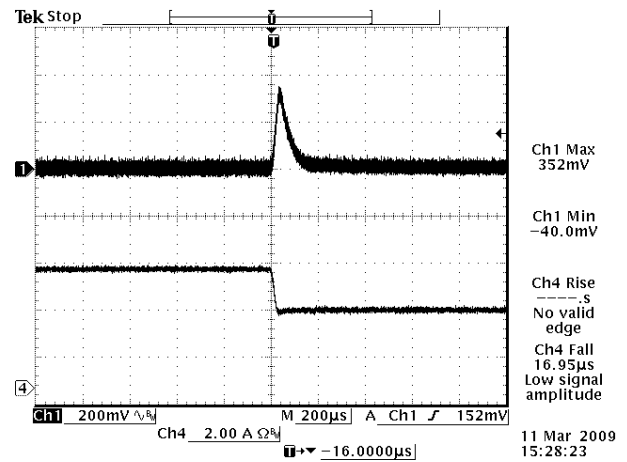

75%-50% Load Transients at $V_{in}=48$ V

NOTE: Transients Response at $V_o=12$ V, $di/dt=0.1$ A/ μ s, with a 0.1 μ F ceramic cap and a 10 μ F tantalum cap at output, and $T_a=25$ °C.

11. THERMAL DERATING CURVE

Maximum FET junction temperature derated to 120° C

ORCY-60U120 & ORCY-60U12L & ORCY-60U12

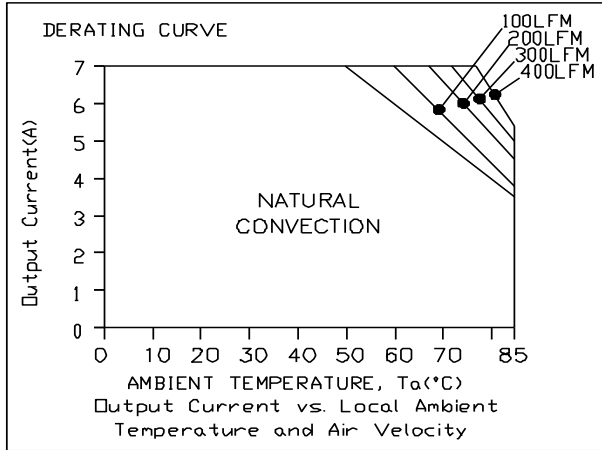

Vin=24 V, Vo=12 V

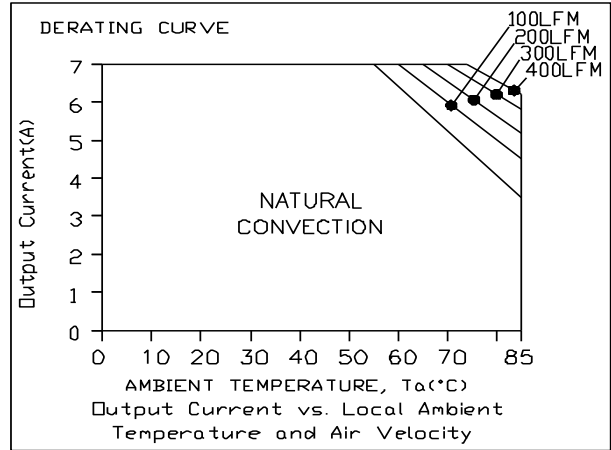

Vin=48 V, Vo=12 V

ORCY-60U12B

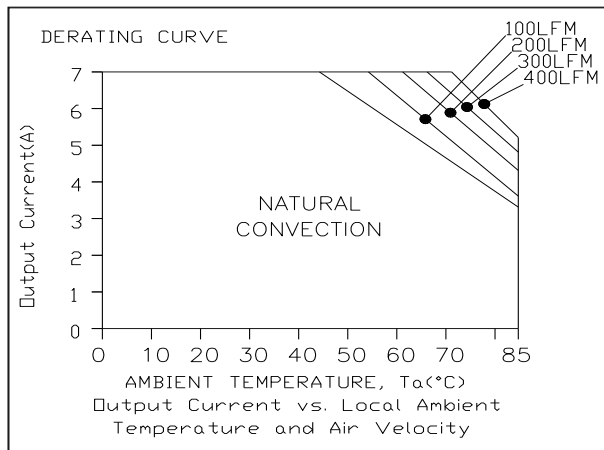

Vin=24 V, Vo=12 V

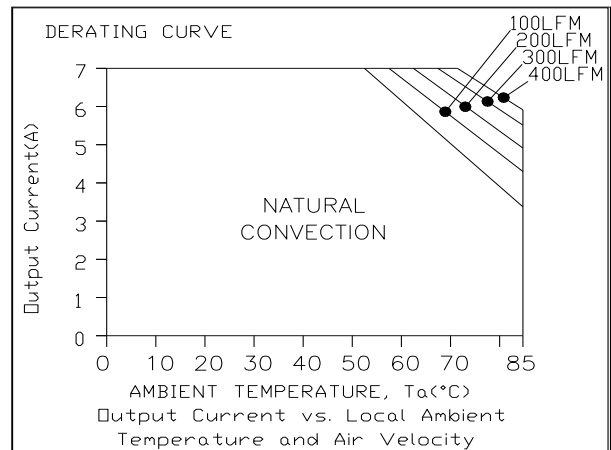

Vin=48 V, Vo=12 V

Note: Output power vs. ambient temperature and air velocity @Vin=56V (Longitudinal Orientation, airflow from Vout to Vin).

12. MECHANICAL DIMENSIONS

OUTLINE

ORCY-60U120 & ORCY-60U12L

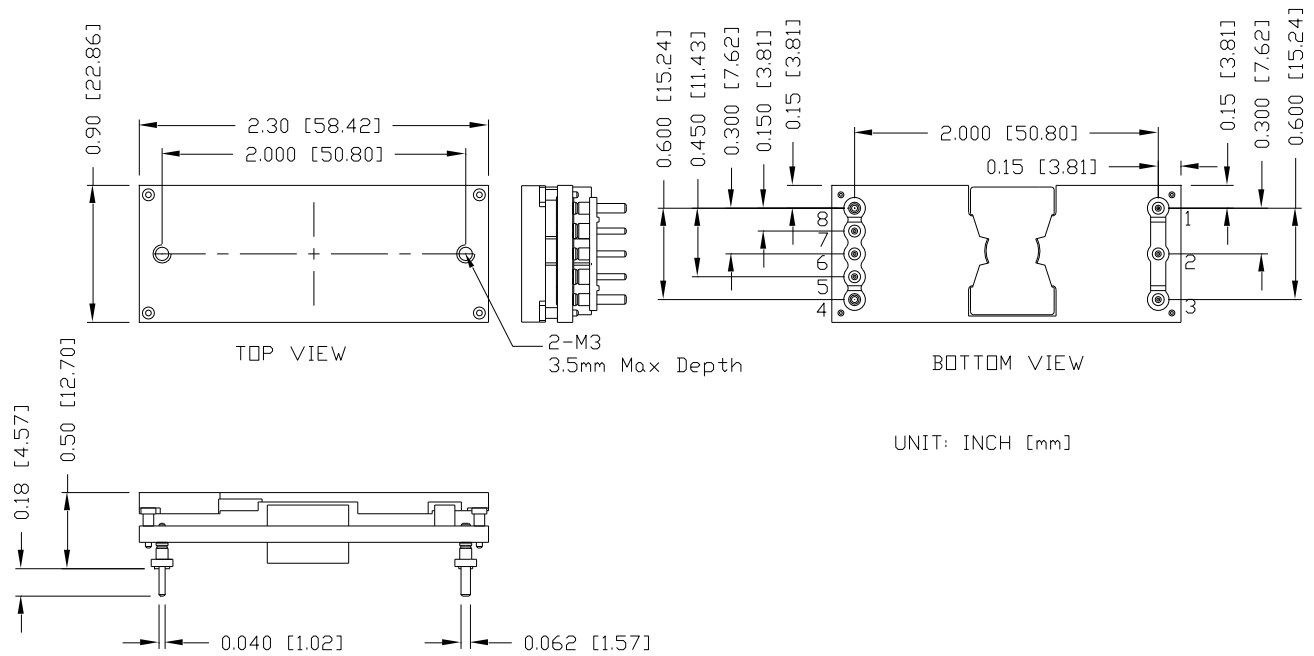

- NOTES:**
1. Pin 5 must be connected to Vout-.
 2. Leave Pin 6 open for nominal voltage.
 3. Pin 7 must be connected to Vout+.

MECHANICAL DIMENSIONS(CONTINUED)

PIN DEFINITIONS

ORCY-60U120 & ORCY-60U12L

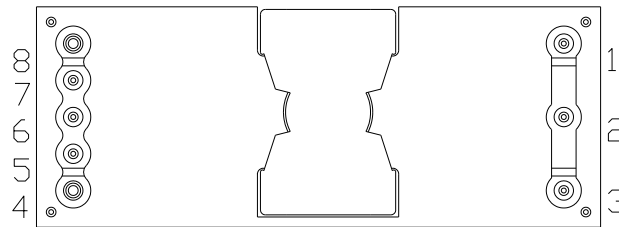

BOTTOM VIEW

PIN	FUNCTION	PIN SIZE
1	Vin (+)	0.04"
2	ON/OFF	0.04"
3	Vin (-)	0.04"
4	Vout(-)	0.062"
5	Sense(-)	0.04"
6	Trim	0.04"
7	Sense(+)	0.04"
8	Vout(+)	0.062"

RECOMMENDED PAD LAYOUT

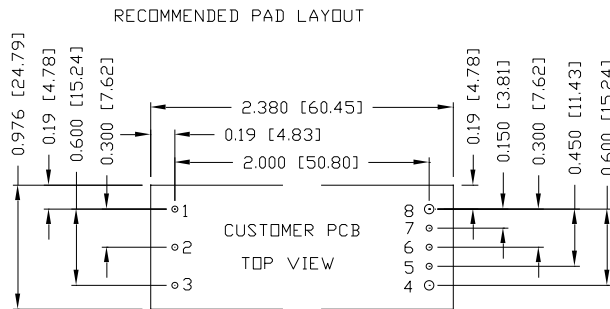

1,2,3,5,6,7 \varnothing 0.047 HOLE SIZE, \varnothing 0.08 min PAD SIZE
 4,8 \varnothing 0.07 HOLE SIZE, \varnothing 0.10 min PAD SIZE

MECHANICAL DIMENSIONS(CONTINUED)

OUTLINE

ORCY-60U12B

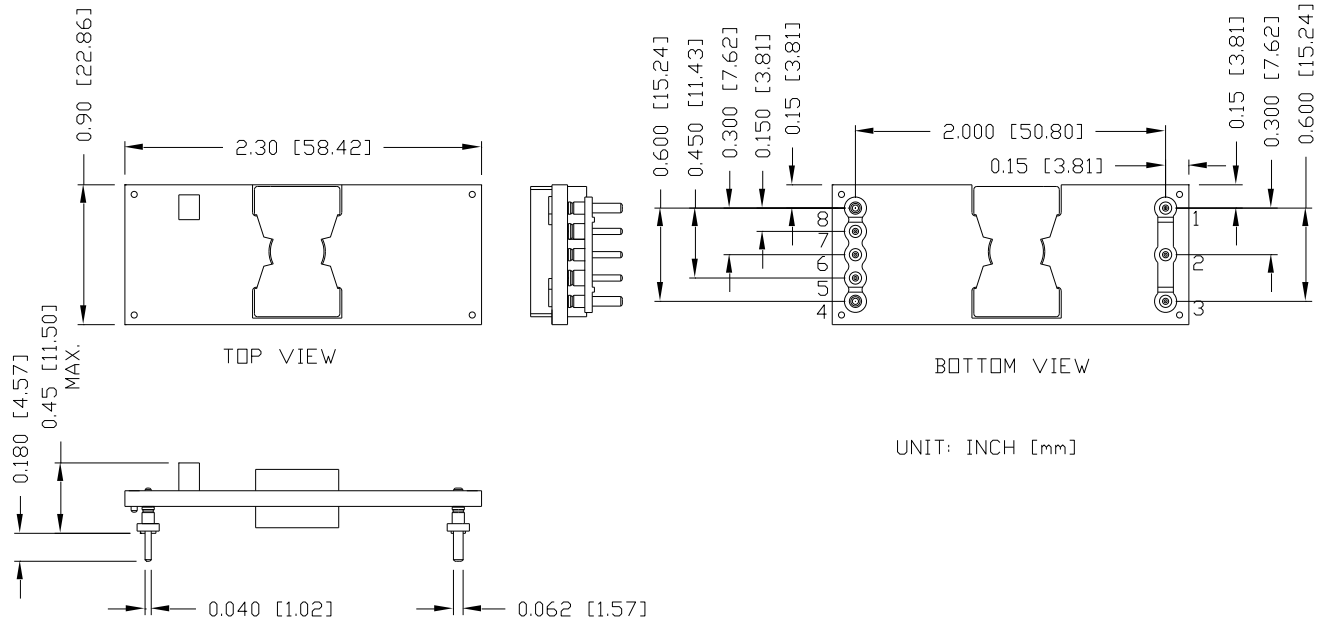

- Notes:**
1. Pin 5 must be connected to Vout-.
 2. Leave Pin 6 open for nominal voltage.
 3. Pin 7 must be connected to Vout+.

MECHANICAL DIMENSIONS(CONTINUED)

PIN DEFINITIONS

ORCY-60U12B

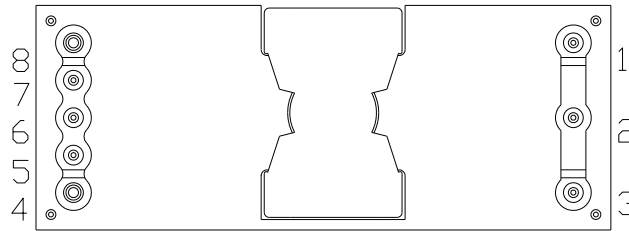

BOTTOM VIEW

PIN	FUNCTION	PIN SIZE
1	Vin (+)	0.04"
2	ON/OFF	0.04"
3	Vin (-)	0.04"
4	Vout(-)	0.062"
5	Sense(-)	0.04"
6	Trim	0.04"
7	Sense(+)	0.04"
8	Vout(+)	0.062"

RECOMMENDED PAD LAYOUT

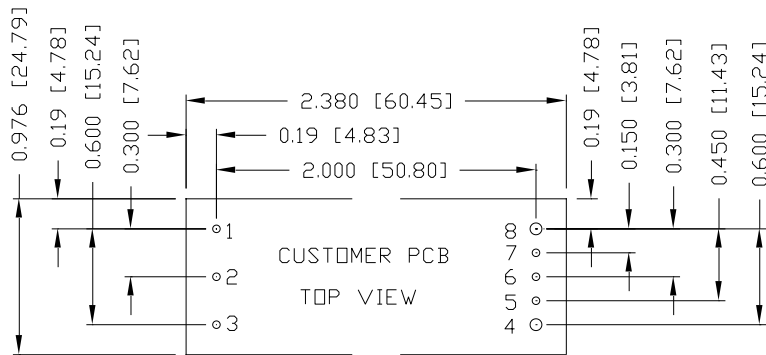

1,2,3,5,6,7 \varnothing 0.047 HOLE SIZE, \varnothing 0.08 min PAD SIZE
 4,8 \varnothing 0.07 HOLE SIZE, \varnothing 0.10 min PAD SIZE

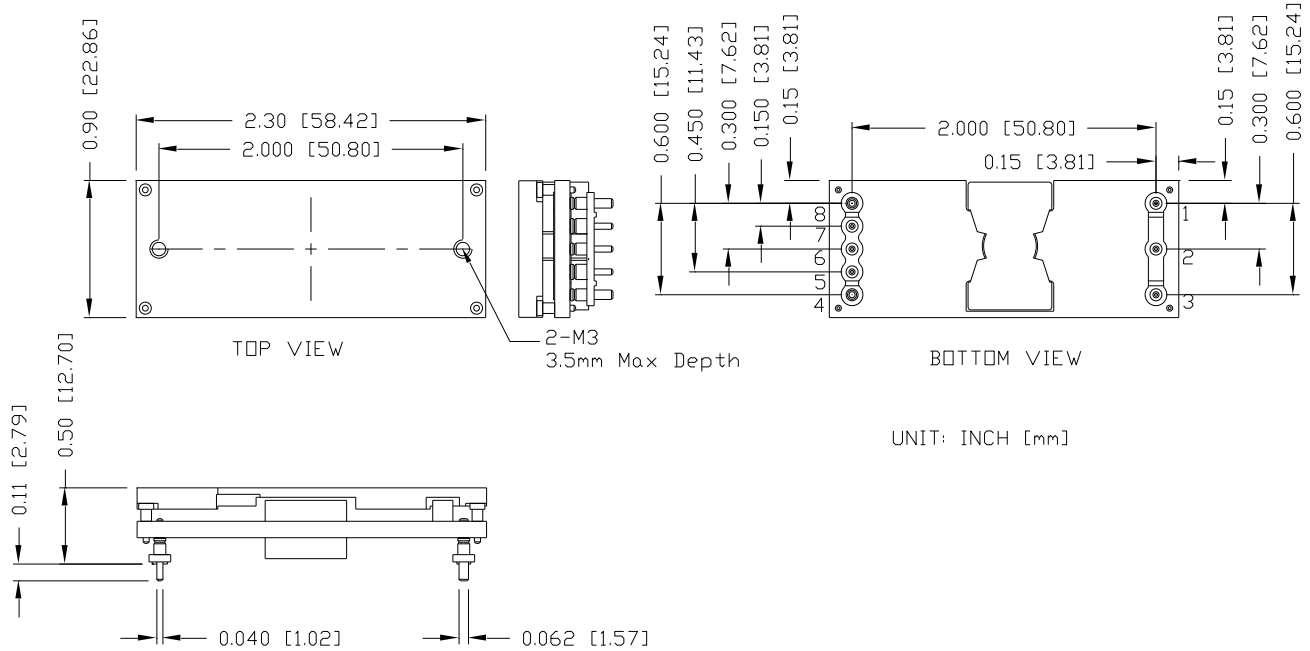
MECHANICAL DIMENSIONS(CONTINUED)**OUTLINE****ORCY-60U12W**

- NOTES:**
1. Pin 5 must be connected to Vout-.
 2. Leave Pin 6 open for nominal voltage.
 3. Pin 7 must be connected to Vout+.

NOTE: This module is recommended and compatible with Pb-Free Wave Soldering and must be soldered using a peak solder temperature of no more than 260 °C for less than 5 seconds.

NOTES:

- 1) All Pins: Material - Copper Alloy;
Finish - Tin plated.
- 2) Undimensioned components are shown for visual reference only.
- 3) All dimensions in inches; Tolerances: x.xx +/-0.02 in [0.51 mm]. x.xxx +/-0.010 in [0.25 mm].

MECHANICAL DIMENSIONS(CONTINUED)

PIN DEFINITIONS

ORCY-60U12W

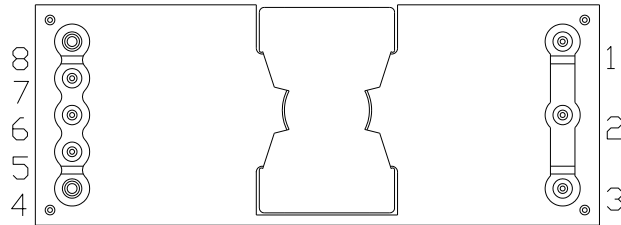

BOTTOM VIEW

PIN	FUNCTION	PIN SIZE
1	Vin (+)	0.04"
2	ON/OFF	0.04"
3	Vin (-)	0.04"
4	Vout(-)	0.062"
5	Sense(-)	0.04"
6	Trim	0.04"
7	Sense(+)	0.04"
8	Vout(+)	0.062"

RECOMMENDED PAD LAYOUT

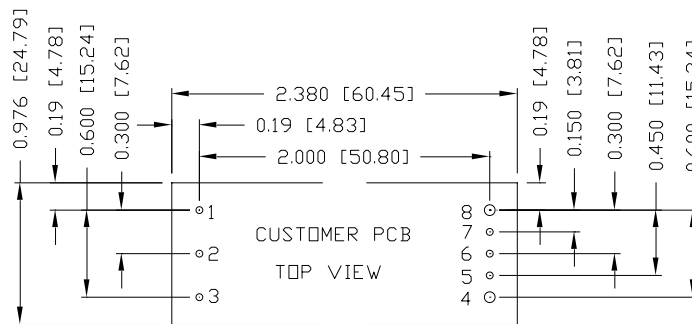

1,2,3,5,6,7 \varnothing 0.047 HOLE SIZE, \varnothing 0.08 min PAD SIZE
 4,8 \varnothing 0.07 HOLE SIZE, \varnothing 0.10 min PAD SIZE

13. REVISION HISTORY

DATE	REVISION	CHANGES DETAIL	APPROVAL
2017-02-09	AA	First release	Jessica Yan
2017-05-24	AC	Update the version, add the new P/N ORCY-6012W	XF Jiang
2018-05-28	AD	Update PN. Explanation	XF Jiang

For more information on these products consult: tech.support@psbel.com

NUCLEAR AND MEDICAL APPLICATIONS - Products are not designed or intended for use as critical components in life support systems, equipment used in hazardous environments, or nuclear control systems.

TECHNICAL REVISIONS - The appearance of products, including safety agency certifications pictured on labels, may change depending on the date manufactured. Specifications are subject to change without notice.