

CATIA V5

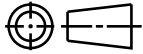

Revision Level			Revision Record	Changed	Date	Approved	Date
Drawing	State	Part					
00.0	Design Release	-	SEE ECN# 014970	JMC	03/22/19	EJH	03/22/19

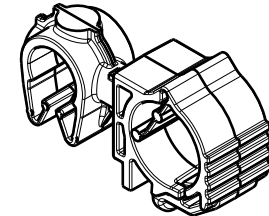
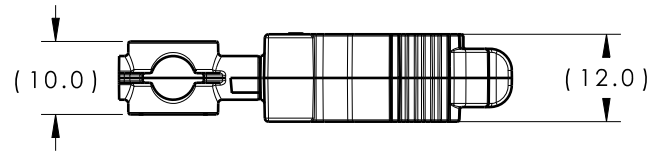

ISOMETRIC VIEW
CLOSED

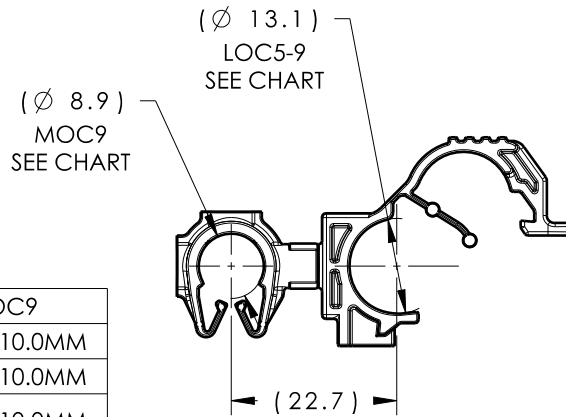

CLIPS ROTATE
360 DEGREES

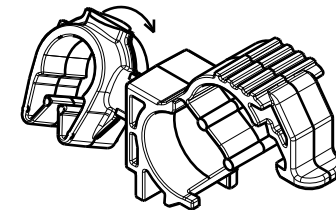

ISOMETRIC VIEW
OPEN

TYPE	MOC9
HARNESS	8.5MM-10.0MM
HOSE	8.0MM-10.0MM
HARD PIPE/TUBE	9.0MM-10.0MM

*RECOMMENDED SIZES MAY DIFFER DEPENDING ON THE APPLICATION, PRODUCT, REQUIRMENTS AND MATERIALS USED

**PATENT PENDING 29/582,271

GLOBAL PART DESCRIPTION	MOC9**			LOC5-9		
	DRAWING	MATERIAL	COLOR	DRAWING	MATERIAL	COLOR
MOC9FLOC5-9-PA66HIRHSUV-BK	16-0317-001-CSU	PA66HIRHSUV	BLACK	12-0430-031-CSU	PA66HIRHSUV	BLACK

Material SEE CHART COLOR: SEE CHART	Units millimeters	The copyright of this drawing is reserved by HellermannTyton. It is issued on condition that it is not reproduced, copied or disclosed to a third party, either wholly or in part, without the consent of HellermannTyton.	Drawn	JMC	03/22/19	Article/Type-No	MOC9FLOC5-9	Scale	1:1	
	Tolerance defined on each dimension		Approved	EJH	03/22/19	Title	9MM MOC COUPLED TO 5-9MM LOC		Project Number	16-0327
			<p>North America Email: corp@htamericas.com Web: www.hellermann.tyton.com</p>			Drawing-No	PRODUCTION : Phase		Format	AH
						16-0327-091-CSU			Sheet	1/1