

F461KJ104J250L

Not for New Design

F461, Film, Metallized Polypropylene, General Purpose, 0.1uF, 5%, 250 VDC, 85°C, Lead Spacing = 7.5mm

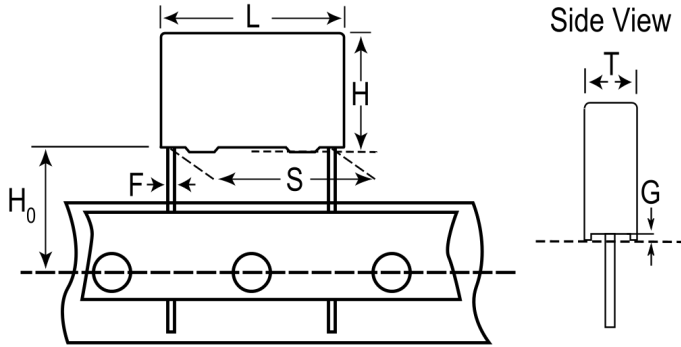

Click [here](#) for the 3D model.

Dimensions

L	10mm -0.5mm
H	10.5mm -0.5mm
T	5mm -0.5mm
S	7.5mm +0.6/-0.1mm
H0	18.5mm +/-0.5mm
F	0.6mm +/-0.05mm
G	0.5mm NOM

Packaging Specifications

Packaging	T&R
Packaging Quantity	1200

General Information

Series	F461
Dielectric	Metallized Polypropylene
Style	Radial
Features	MKP, Pulse
RoHS	Yes
Lead	Wire Leads
AEC-Q200	No
Component Weight	1.09 g
Miscellaneous	The Rated Voltage Decreases 2%/C Between +85C And +105C (1.25%/C For AC). ClimCat: 55/105/56.
Notes	Series Replaced by R75.

Specifications

Capacitance	0.1 uF
Capacitance Tolerance	5%
Voltage AC	160 VAC
Voltage DC	250 VDC, 150 VDC (105C)
Temperature Range	-55/+105°C
Rated Temperature	85°C
Dissipation Factor	0.04% 1kHz, 0.06% 10kHz, 0.25% 100kHz
Insulation Resistance	100 GOhms
Max dV/dt	650 V/us
Inductance	6 nH

Statements of suitability for certain applications are based on our knowledge of typical operating conditions for such applications, but are not intended to constitute - and we specifically disclaim - any warranty concerning suitability for a specific customer application or use. This information is intended for use only by customers who have the requisite experience and capability to determine the correct products for their application. Any technical advice inferred from this information or otherwise provided by us with reference to the use of our products is given gratis, and we assume no obligation or liability for the advice given or results obtained.