

## High Performance Schottky Rectifier, 18 A

**TO-220AC**

### FEATURES

- 175 °C  $T_J$  operation
- Low forward voltage drop
- High frequency operation
- High purity, high temperature epoxy encapsulation for enhanced mechanical strength and moisture resistance
- Guard ring for enhanced ruggedness and long term reliability
- AEC-Q101 qualified meets JESD 201 class 2 whisker test
- Material categorization: for definitions of compliance please see [www.vishay.com/doc?99912](http://www.vishay.com/doc?99912)

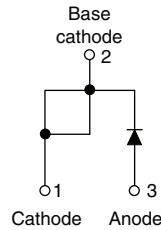

PRIMARY CHARACTERISTICS	
$I_{F(AV)}$	18 A
$V_R$	35 V, 40 V, 45 V
$V_F$ at $I_F$	0.53 V
$I_{RM}$ max.	25 mA at 125 °C
$T_J$ max.	175 °C
$E_{AS}$	24 mJ
Package	TO-220AC
Circuit configuration	Single

### DESCRIPTION

The VS-18TQ... Schottky rectifier series has been optimized for low reverse leakage at high temperature. The proprietary barrier technology allows for reliable operation up to 175 °C junction temperature. Typical applications are in switching power supplies, converters, freewheeling diodes, and reverse battery protection.

MAJOR RATINGS AND CHARACTERISTICS			
SYMBOL	CHARACTERISTICS	VALUES	UNITS
$I_{F(AV)}$	Rectangular waveform	18	A
$V_{RRM}$	Range	35 to 45	V
$I_{FSM}$	$t_p = 5 \mu s$ sine	1800	A
$V_F$	18 A <sub>pk</sub> , $T_J = 125$ °C	0.53	V
$T_J$	Range	-55 to +175	°C

VOLTAGE RATINGS					
PARAMETER	SYMBOL	VS-18TQ035HN3	VS-18TQ040HN3	VS-18TQ045HN3	UNITS
Maximum DC reverse voltage	$V_R$	35	40	45	V
Maximum working peak reverse voltage	$V_{RWM}$				

ABSOLUTE MAXIMUM RATINGS					
PARAMETER	SYMBOL	TEST CONDITIONS		VALUES	UNITS
Maximum average forward current See fig. 5	$I_{F(AV)}$	50 % duty cycle at $T_C = 149$ °C, rectangular waveform		18	A
Maximum peak one cycle non-repetitive surge current See fig. 7	$I_{FSM}$	5 $\mu s$ sine or 3 $\mu s$ rect. pulse	Following any rated load condition and with rated $V_{RRM}$ applied	1800	
		10 ms sine or 6 ms rect. pulse			390
Non-repetitive avalanche energy	$E_{AS}$	$T_J = 25$ °C, $I_{AS} = 3.6$ A, $L = 3.7$ mH		24	mJ
Repetitive avalanche current	$I_{AR}$	Current decaying linearly to zero in 1 $\mu s$ Frequency limited by $T_J$ maximum $V_A = 1.5 \times V_R$ typical		3.6	A



ELECTRICAL SPECIFICATIONS					
PARAMETER	SYMBOL	TEST CONDITIONS		VALUES	UNITS
Maximum forward voltage drop See fig. 1	$V_{FM}^{(1)}$	18 A	$T_J = 25\text{ }^\circ\text{C}$	0.60	V
		36 A		0.72	
		18 A	$T_J = 125\text{ }^\circ\text{C}$	0.53	
		36 A		0.67	
Maximum reverse leakage current See fig. 2	$I_{RM}^{(1)}$	$T_J = 25\text{ }^\circ\text{C}$	$V_R = \text{Rated } V_R$	2.5	mA
		$T_J = 125\text{ }^\circ\text{C}$		25	
Maximum junction capacitance	$C_T$	$V_R = 5\text{ }V_{DC}$ (test signal range 100 kHz to 1 MHz) 25 °C		1400	pF
Typical series inductance	$L_S$	Measured lead to lead 5 mm from package body		8	nH
Maximum voltage rate of change	dV/dt	Rated $V_R$		10 000	V/ $\mu$ s

**Note**(1) Pulse width < 300  $\mu$ s, duty cycle < 2 %

THERMAL - MECHANICAL SPECIFICATIONS					
PARAMETER	SYMBOL	TEST CONDITIONS		VALUES	UNITS
Maximum junction and storage temperature range	$T_J, T_{Stg}$			-55 to 175	$^\circ\text{C}$
Maximum thermal resistance, junction to case	$R_{thJC}$	DC operation See fig. 4		1.50	$^\circ\text{C}/\text{W}$
Typical thermal resistance, case to heatsink	$R_{thCS}$	Mounting surface, smooth and greased		0.50	
Approximate weight				2	g
				0.07	oz.
Mounting torque	minimum maximum			6 (5)	kgf · cm (lbf · in)
				12 (10)	
Marking device		Case style TO-220AC		18TQ035H	
				18TQ040H	
				18TQ045H	

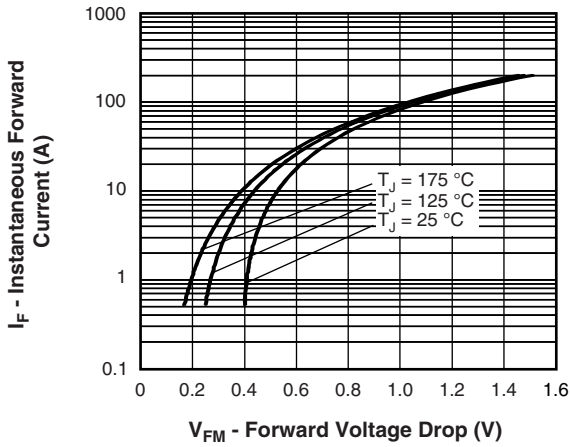

Fig. 1 - Maximum Forward Voltage Drop Characteristics

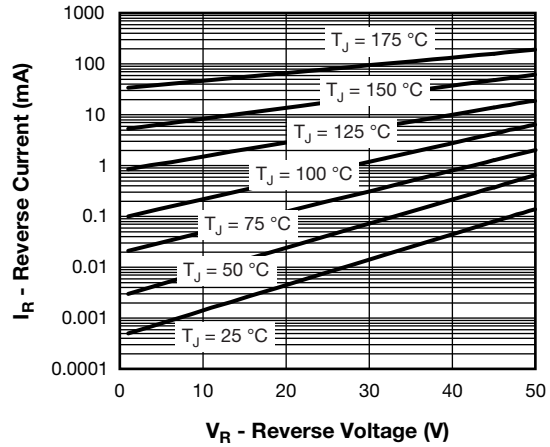

Fig. 2 - Typical Values of Reverse Current vs. Reverse Voltage

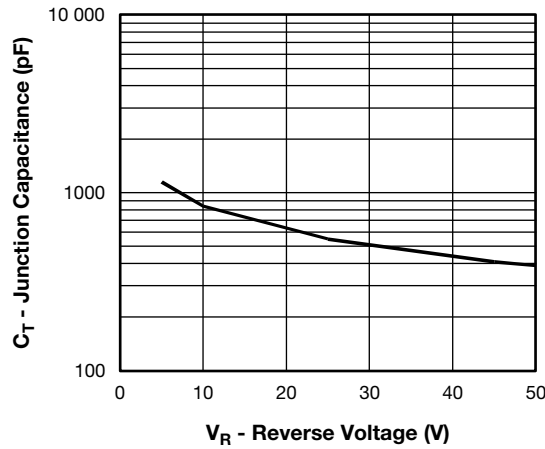

Fig. 3 - Typical Junction Capacitance vs. Reverse Voltage

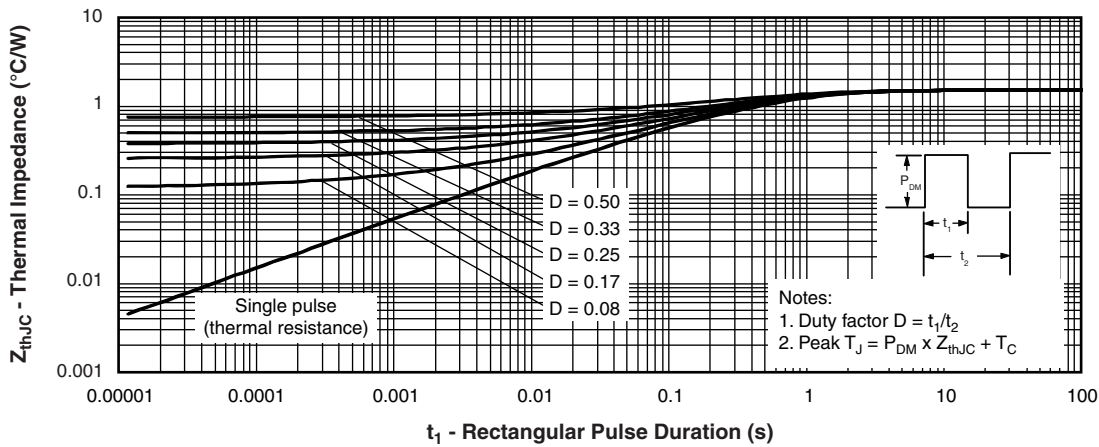

Fig. 4 - Maximum Thermal Impedance  $Z_{thJC}$  Characteristics

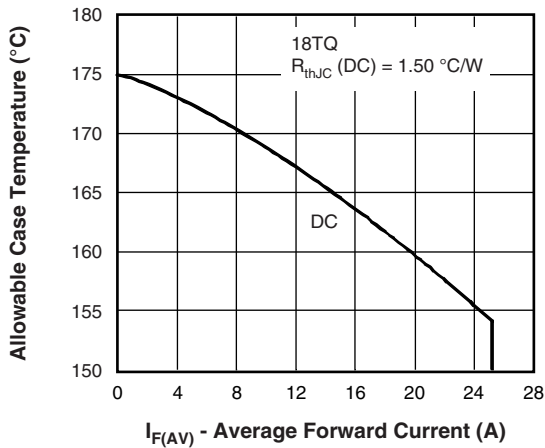

Fig. 5 - Maximum Allowable Case Temperature vs. Average Forward Current

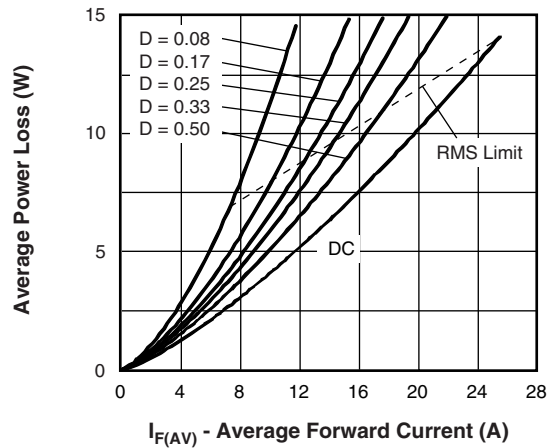

Fig. 6 - Forward Power Loss Characteristics

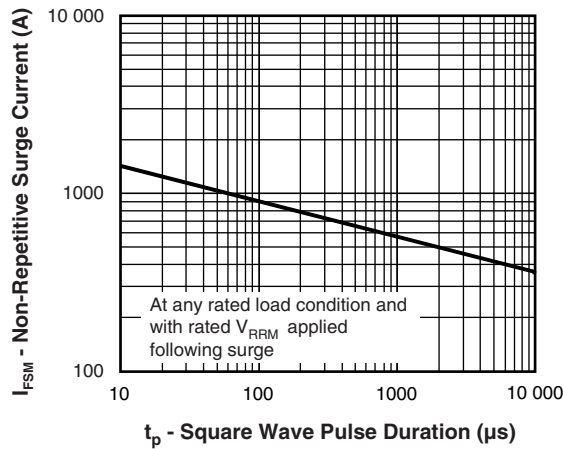

Fig. 7 - Maximum Non-Repetitive Surge Current

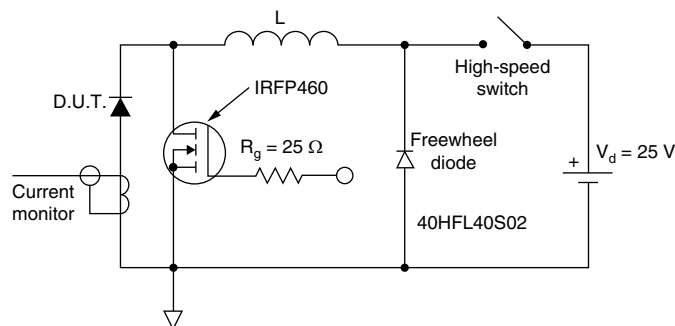
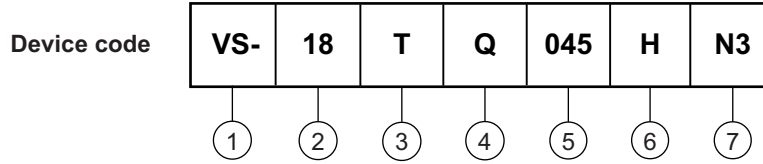

Fig. 8 - Unclamped Inductive Test Circuit



ORDERING INFORMATION TABLE



- 1** - Vishay Semiconductors product
  - 2** - Current rating (18 = 18 A)
  - 3** - Package:  
T = TO-220
  - 4** - Schottky "Q" series
  - 5** - Voltage ratings
  - 6** - H = AEC-Q101 qualified
  - 7** - Environmental digit
    - N3 = Halogen-free, RoHS-compliant, and totally lead (Pb)-free
- |            |
|------------|
| 035 = 35 V |
| 040 = 40 V |
| 045 = 45 V |

ORDERING INFORMATION (Example)			
PREFERRED P/N	QUANTITY PER T/R	MINIMUM ORDER QUANTITY	PACKAGING DESCRIPTION
VS-18TQ035HN3	50	1000	Antistatic plastic tube
VS-18TQ040HN3	50	1000	Antistatic plastic tube
VS-18TQ045HN3	50	1000	Antistatic plastic tube

LINKS TO RELATED DOCUMENTS	
Dimensions	<a href="http://www.vishay.com/doc?95221">www.vishay.com/doc?95221</a>
Part marking information TO-220AC-N3	<a href="http://www.vishay.com/doc?95068">www.vishay.com/doc?95068</a>
SPICE model	<a href="http://www.vishay.com/doc?96209">www.vishay.com/doc?96209</a>

### TO-220AC

**DIMENSIONS** in millimeters and inches

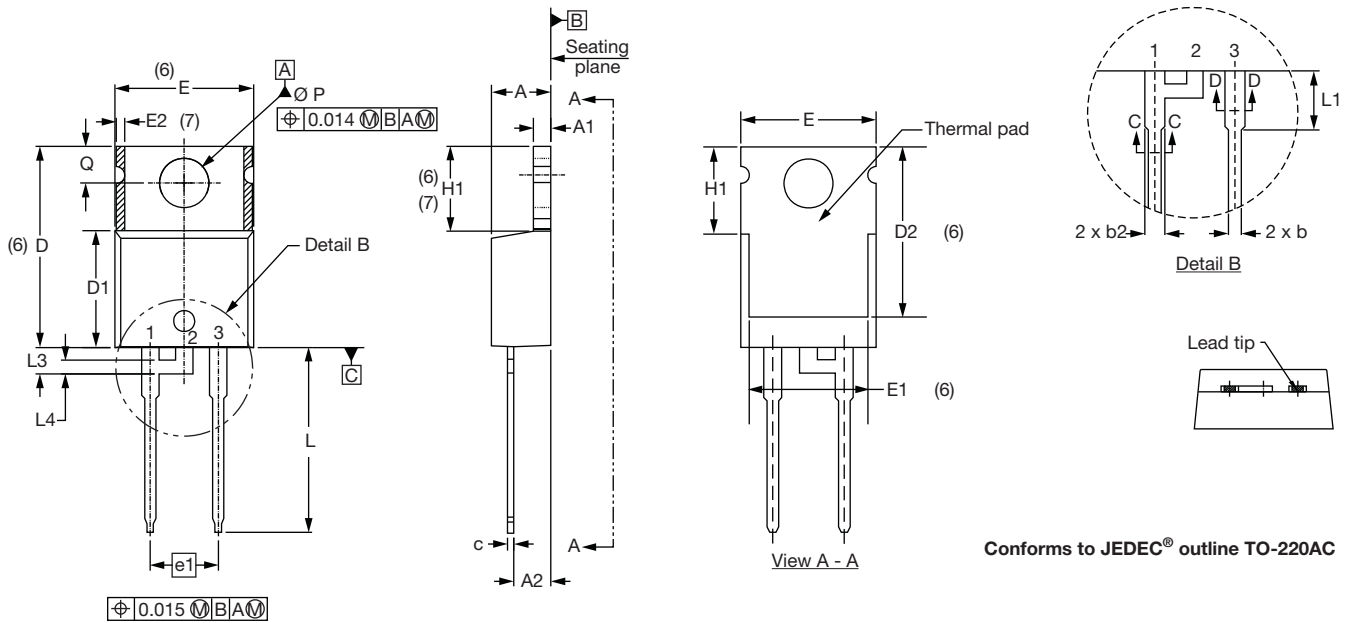

SYMBOL	MILLIMETERS		INCHES		NOTES
	MIN.	MAX.	MIN.	MAX.	
A	4.25	4.65	0.167	0.183	
A1	1.14	1.40	0.045	0.055	
A2	2.56	2.92	0.101	0.115	
b	0.69	1.01	0.027	0.040	
b1	0.38	0.97	0.015	0.038	4
b2	1.20	1.73	0.047	0.068	
b3	1.14	1.73	0.045	0.068	4
c	0.36	0.61	0.014	0.024	
c1	0.36	0.56	0.014	0.022	4
D	14.85	15.25	0.585	0.600	3
D1	8.38	9.02	0.330	0.355	
D2	11.68	12.88	0.460	0.507	6
E	10.11	10.51	0.398	0.414	3, 6
E1	6.86	8.89	0.270	0.350	6
E2	-	0.76	-	0.030	7
e1	4.88	5.28	0.192	0.208	
H1	5.84	6.86	0.230	0.270	6, 7
L	13.52	14.02	0.532	0.552	
L1	3.32	3.82	0.131	0.150	2
L3	1.78	2.13	0.070	0.084	
L4	0.76	1.27	0.030	0.050	2
Ø P	3.54	3.73	0.139	0.147	
Q	2.60	3.00	0.102	0.118	

**Notes**

- (1) Dimensioning and tolerancing as per ASME Y14.5M-1994
- (2) Lead dimension and finish uncontrolled in L1
- (3) Dimension D, D1 and E do not include mold flash. Mold flash shall not exceed 0.127 mm (0.005") per side. These dimensions are measured at the outermost extremes of the plastic body
- (4) Dimension b1, b3 and c1 apply to base metal only
- (5) Controlling dimension: inches
- (6) Thermal pad contour optional within dimensions E, H1, D2 and E1
- (7) Dimension E2 x H1 define a zone where stamping and singulation irregularities are allowed
- (8) Outline conforms to JEDEC TO-220, D2 (minimum) where dimensions are derived from the actual package outline



## Disclaimer

ALL PRODUCT, PRODUCT SPECIFICATIONS AND DATA ARE SUBJECT TO CHANGE WITHOUT NOTICE TO IMPROVE RELIABILITY, FUNCTION OR DESIGN OR OTHERWISE.

Vishay Intertechnology, Inc., its affiliates, agents, and employees, and all persons acting on its or their behalf (collectively, "Vishay"), disclaim any and all liability for any errors, inaccuracies or incompleteness contained in any datasheet or in any other disclosure relating to any product.

Vishay makes no warranty, representation or guarantee regarding the suitability of the products for any particular purpose or the continuing production of any product. To the maximum extent permitted by applicable law, Vishay disclaims (i) any and all liability arising out of the application or use of any product, (ii) any and all liability, including without limitation special, consequential or incidental damages, and (iii) any and all implied warranties, including warranties of fitness for particular purpose, non-infringement and merchantability.

Statements regarding the suitability of products for certain types of applications are based on Vishay's knowledge of typical requirements that are often placed on Vishay products in generic applications. Such statements are not binding statements about the suitability of products for a particular application. It is the customer's responsibility to validate that a particular product with the properties described in the product specification is suitable for use in a particular application. Parameters provided in datasheets and / or specifications may vary in different applications and performance may vary over time. All operating parameters, including typical parameters, must be validated for each customer application by the customer's technical experts. Product specifications do not expand or otherwise modify Vishay's terms and conditions of purchase, including but not limited to the warranty expressed therein.

Hyperlinks included in this datasheet may direct users to third-party websites. These links are provided as a convenience and for informational purposes only. Inclusion of these hyperlinks does not constitute an endorsement or an approval by Vishay of any of the products, services or opinions of the corporation, organization or individual associated with the third-party website. Vishay disclaims any and all liability and bears no responsibility for the accuracy, legality or content of the third-party website or for that of subsequent links.

Except as expressly indicated in writing, Vishay products are not designed for use in medical, life-saving, or life-sustaining applications or for any other application in which the failure of the Vishay product could result in personal injury or death. Customers using or selling Vishay products not expressly indicated for use in such applications do so at their own risk. Please contact authorized Vishay personnel to obtain written terms and conditions regarding products designed for such applications.

No license, express or implied, by estoppel or otherwise, to any intellectual property rights is granted by this document or by any conduct of Vishay. Product names and markings noted herein may be trademarks of their respective owners.