

ZMW Series Mini Size Snap-acting Switches

NEW



Features/Benefits

- Long & adequate stroke setting for high reliability & insulation
- Silent actuation for reduced audible click
- Compact size – ideal when space is limited
- Twin contacts design – sliding contacts prevent pollution of foreign materials
- IP67 for standalone switch except the metal terminal part; Full IP67 protection when potted with wire version
- RoHS compatible & compliant

Typical Applications

- Industrial
- Home appliances
- Automotive: door latch, seat position detection, EV charging

Specifications

CONTACT RATING: 100mA 30VDC @ 300,000 cycles min.
50mA 16VDC @ 500,000 cycles min.
1mA 5VDC @ 500,000 cycles min.

MECHANICAL LIFE: 500,000 cycles min.

INSULATION RESISTANCE: 100 M ohm min.

DIELECTRIC STRENGTH: Min. 600VAC (50-60Hz)/minute
between Live Parts

OPERATING TEMPERATURE: -40°C to 85°C

OPERATING FORCE: 150 gf max.

Materials

CASE: Nylon

COVER: PBT

ACTUATOR BUTTON: POM

MOVABLE CONTACTS: Silver alloy or gold plated

STATIONARY CONTACTS: Silver alloy or gold plated

TERMINALS: Brass, silver plated.

NOTE: Specifications and materials listed above are for switches with standard options. For information on specific and custom switches, consult Customer Service Center.

⚠ Sealing cap could possibly be damaged in case of contacts with oils or greases. Please try to avoid direct contact. If more support is needed, consult Customer Service Centre.

Build-A-Switch

Our easy build-a-switch concept allows you to mix and match options to create the switch you need. To order, select desired option from each category and place it in the appropriate box.

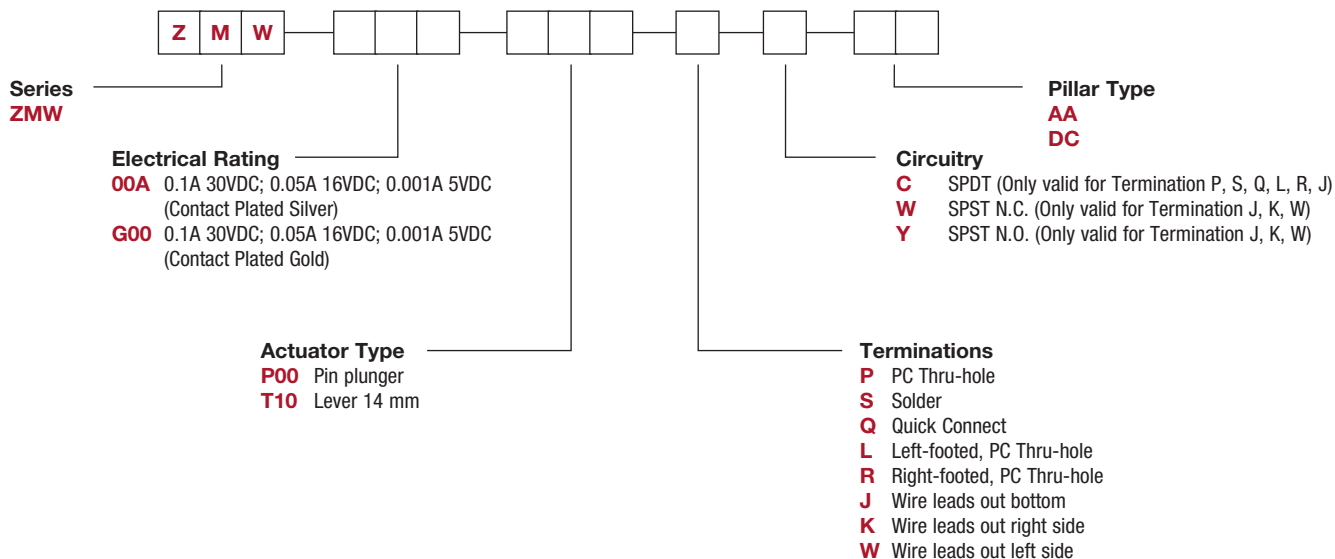

NEW

ZMW Series Mini Size Snap-acting Switches

SERIES

ZMW MINI SIZE SNAP-ACTING SWITCHES

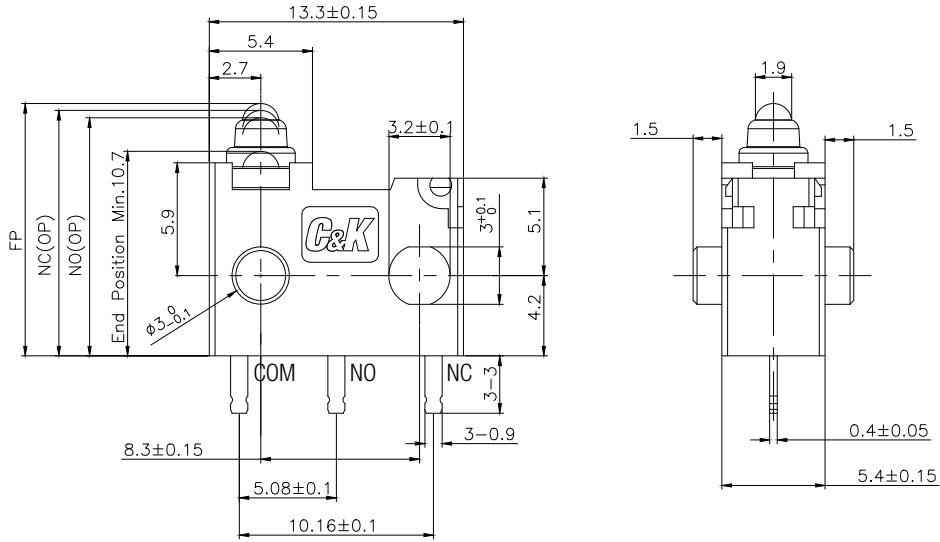

MOUNTING HOLES

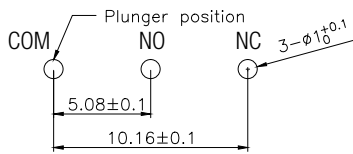

ACTUATOR TYPE

P00 PIN PLUNGER

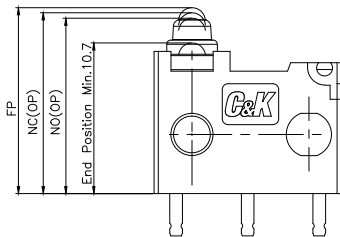

T10 LEVER
14 MM

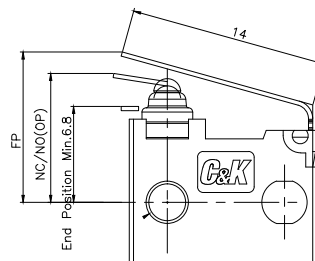

Snap-acting

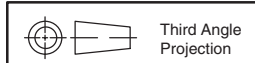

ZMW Series Mini Size Snap-acting Switches

NEW

TERMINATIONS

P PC THRU-HOLE

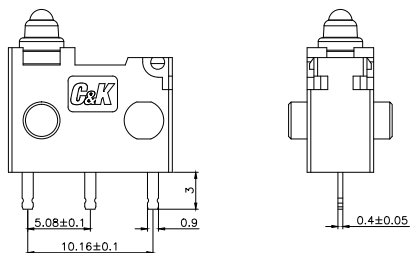

S SOLDER

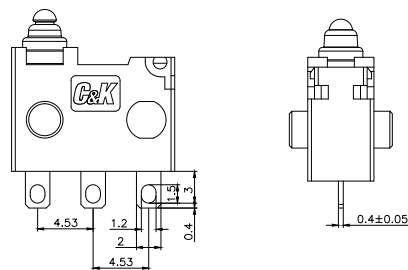

Q QUICK CONNECT

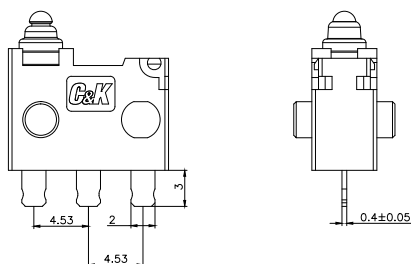

L LEFT-FOOTED,
PC THRU-HOLE

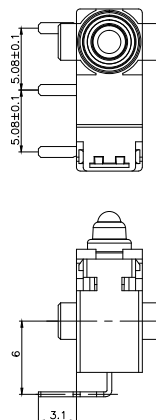

R RIGHT-FOOTED,
PC THRU-HOLE

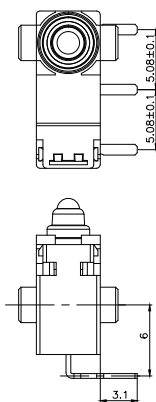

J WIRE LEADS OUT BOTTOM

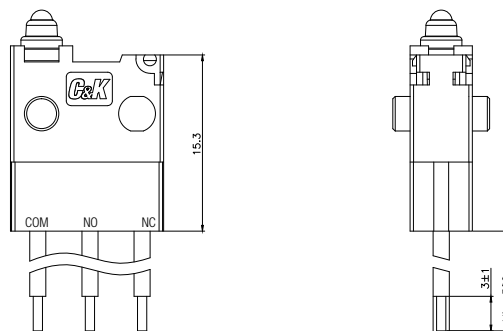

K WIRE LEADS OUT RIGHT SIDE

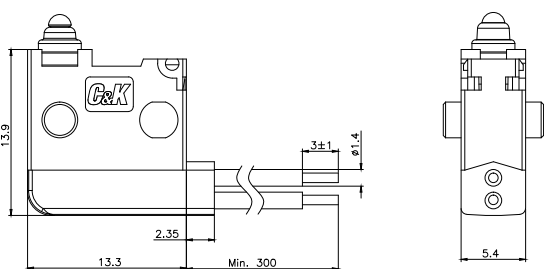

W WIRE LEADS OUT LEFT SIDE

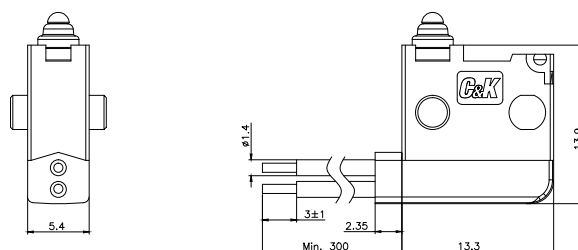

COM: AVSS 0.3 MM² BLACK OR EQUIVALENT
NO: AVSS 0.3 MM² BLUE OR EQUIVALENT
NC: AVSS 0.3 MM² GRAY OR EQUIVALENT

Dimensions are shown: mm
Specifications and dimensions subject to change

C&K

27 Aug 20

J-74

www.ckswitches.com

Snap-acting

NEW

ZMW Series Mini Size Snap-acting Switches

SWITCH CHARACTERISTICS

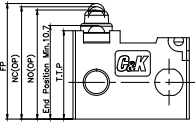
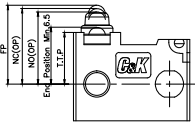
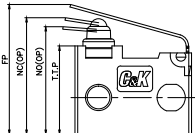
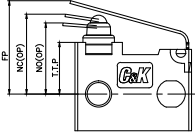
SWITCH TYPE	PART SUFFIX	OF Max (gf)	FP Max (mm)	NC-OP (mm)	NO-OP (mm)	NC-OT Min.(mm)	NO-OT Min. (mm)	
ZMWXXXP00XXXX	 Datum from Bottom	S	153	13.4	12.9±0.3	12.6±0.3	2.5	2.2
	 Datum from Centre			9.2	8.7±0.3	8.4±0.3		
ZMWXXXT10XXXX	 Datum from Bottom	S	185	15.7	14.0±0.6	13.45±0.6	3.0	2.45
	 Datum from Centre			11.5	9.8±0.6	9.25±0.6		

PILLAR TYPE

DC

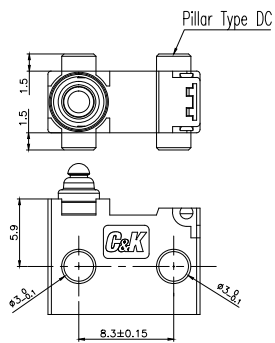

AA

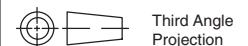
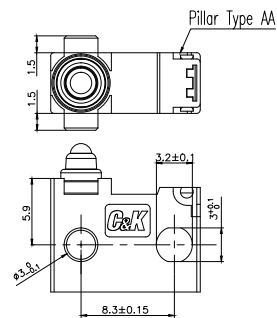

Dimensions are shown: mm
Specifications and dimensions subject to change



Snap-acting