

SiC SBD P3D06008T2 650V SiC Schottky Diode

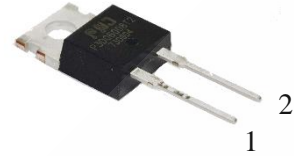

Features

- Qualified to AEC-Q101
- Ultra-Fast Switching
- Zero Reverse Recovery Current
- High-Frequency Operation
- Positive Temperature Coefficient on V_F
- High Surge Current
- 100% UIS tested

TO-220-2

Cathode	1
Anode	2



Standards Benefits

- Improve System Efficiency
- Reduction of Heat Sink Requirement
- Essentially No Switching Losses
- Parallel Devices Without Thermal Runaway



Applications

- Consumer SMPS
- Boost Diodes in PFC or DC/DC Stages
- AC/DC Converters



Order Information

Part Number	Package	Marking
P3D06008T2	TO-220-2	P3D06008T2



Contents

Features.....	1
Standards Benefits	1
Applications.....	1
Order Information	1
Contents.....	2
1. Maximum Ratings.....	3
2. Thermal Characteristics.....	3
3. Electrical Characteristics	4
4. Typical Performance	5
5. Package Outlines.....	7

PN Junction Semiconductor

1. Maximum Ratings

At $T_J = 25^\circ\text{C}$, unless specified otherwise

Parameter	Symbol	Value	Unit	Test condition
Repetitive Peak Reverse Voltage	V_{RRM}	650	V	$T_C = 25^\circ\text{C}$
Surge Peak Reverse Voltage	V_{RSM}	650	V	$T_C = 25^\circ\text{C}$
DC Blocking Voltage	V_R	650	V	$T_C = 25^\circ\text{C}$
Forward Current	I_F	26	A	$T_C = 25^\circ\text{C}$
		13		$T_C = 125^\circ\text{C}$
		8		$T_C = 153^\circ\text{C}$
Repetitive Peak Forward Surge Current	I_{FRM}	45	A	$T_C = 25^\circ\text{C}, t_p = 10\text{ms}$
		22		$T_C = 125^\circ\text{C}, t_p = 10\text{ms}$
Non-Repetitive Forward Surge Current	I_{FSM}	60	A	$T_C = 25^\circ\text{C}, t_p = 10\text{ms}$
		52		$T_C = 125^\circ\text{C}, t_p = 10\text{ms}$
Non-Repetitive Forward Surge Current	$I_{F, MAX}$	727	A	$T_C = 25^\circ\text{C}, t_p = 10\mu\text{s}$
		697		$T_C = 125^\circ\text{C}, t_p = 10\mu\text{s}$
Power Dissipation	P_{tot}	109	W	$T_C = 25^\circ\text{C}$
Operating Junction and Storage Temperature	T_J, T_{STG}	-55 to +175	$^\circ\text{C}$	
TO-220 Mounting Torque M3 Screw	T_{orq}	1	Nm lbf-in	
		8.8		

2. Thermal Characteristics

Parameter	Symbol	Values	Unit
Thermal Resistance from Junction to Case	$R_{\theta JC}$	1.38	$^\circ\text{C}/\text{W}$

3. Electrical Characteristics

At $T_J = 25^\circ\text{C}$, unless specified otherwise

Parameter	Symbol	Values			Unit	Test condition
		Min.	Typ.	Max.		
Forward Voltage	V_F	/	1.39	1.6	V	$I_F = 8\text{A}, T_J = 25^\circ\text{C}$
			1.65	/		$I_F = 8\text{A}, T_J = 175^\circ\text{C}$
Reverse Current	I_R	/	10.2	36	μA	$V_R = 650\text{V}, T_J = 25^\circ\text{C}$
			301	/		$V_R = 650\text{V}, T_J = 175^\circ\text{C}$
Total Capacitance	C	/	346	/	pF	$V_R = 0\text{V}, T_J = 25^\circ\text{C}$ $f = 1\text{MHz}$
			39			$V_R = 200\text{V}, T_J = 25^\circ\text{C}$ $f = 1\text{MHz}$
			30			$V_R = 400\text{V}, T_J = 25^\circ\text{C}$ $f = 1\text{MHz}$
Total Capacitive Charge	Q_C	/	19.6	/	nC	$V_R = 400\text{V}, I_F = 8\text{A}$ $T_J = 25^\circ\text{C}$
Capacitance Stored Energy	E_C	/	2.42	/	μJ	$V_R = 400\text{V}$

4. Typical Performance

At $T_J = 25^\circ\text{C}$, unless specified otherwise

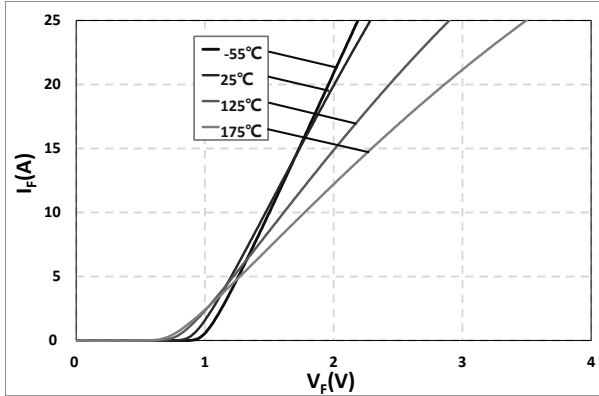

Fig. 1 Typical Forward Characteristics
 $I_F = f(V_F)$; $T_J = -55^\circ\text{C}, 25^\circ\text{C}, 125^\circ\text{C}, 175^\circ\text{C}$

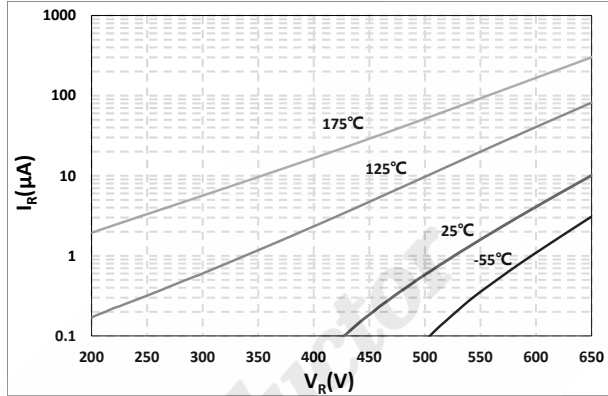

Fig. 2 Reverse Characteristics
 $I_R = f(V_R)$; $T_J = -55^\circ\text{C}, 25^\circ\text{C}, 125^\circ\text{C}, 175^\circ\text{C}$

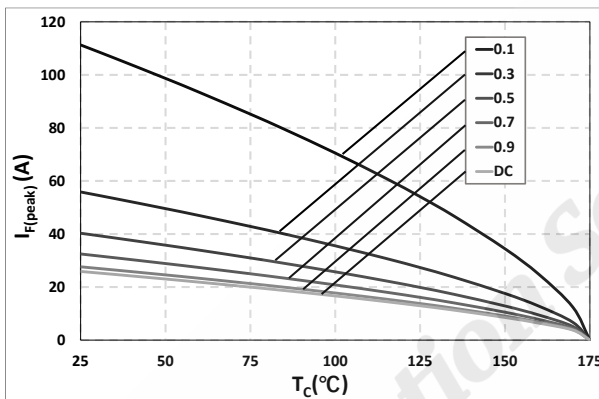

Fig. 3 Current Derating

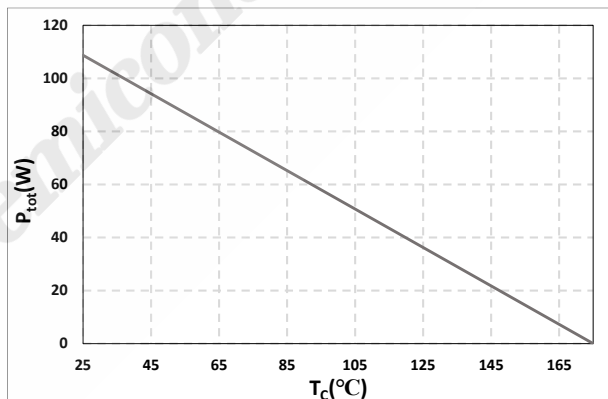

Fig. 4 Typical Power Derating
 $P_{tot} = f(T_C)$

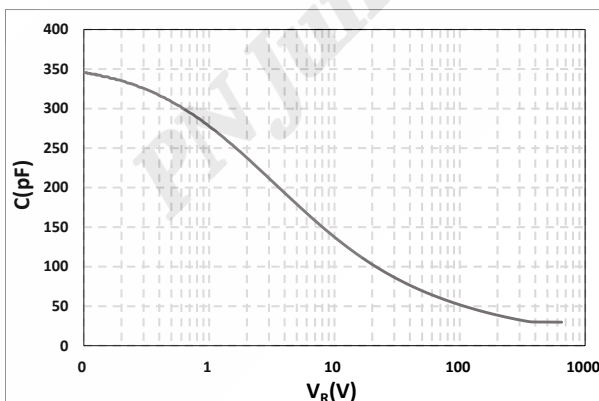

Fig. 5 Typical Total Capacitance
 $C = f(V_R)$

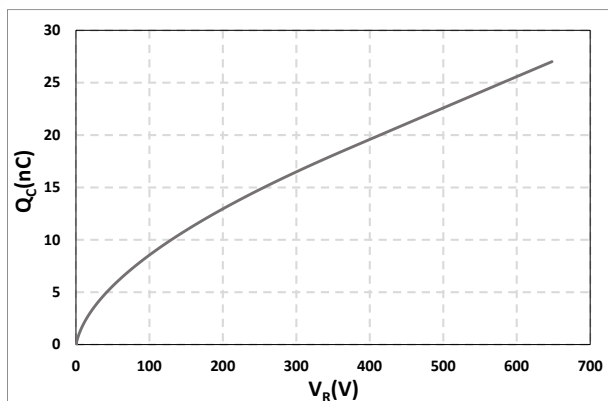

Fig. 6 Typical Total Capacitive Charge
 $Q_C = f(V_R)$

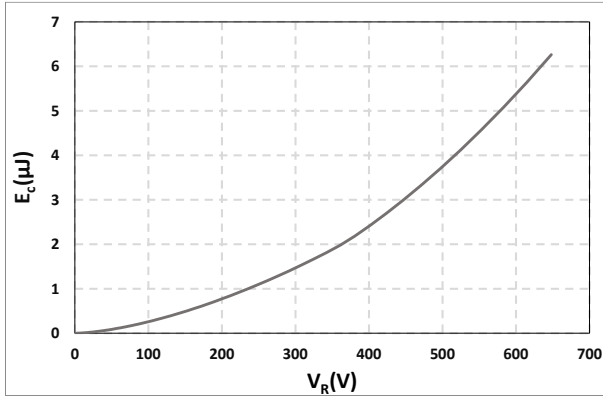

Figure 7. Capacitance Stored Energy
 $E_C = f(V_R)$

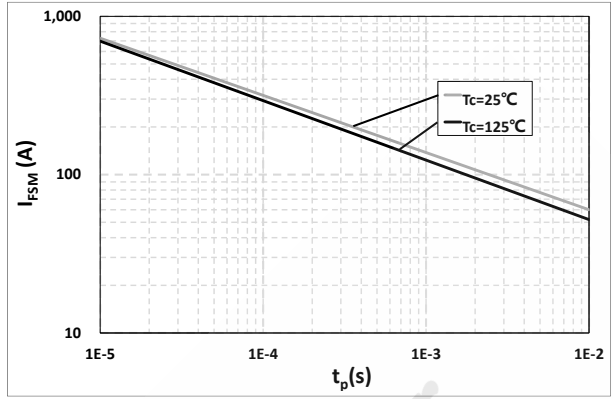

Figure 8. Non-repetitive peak forward surge current versus pulse duration (sinusoidal waveform)

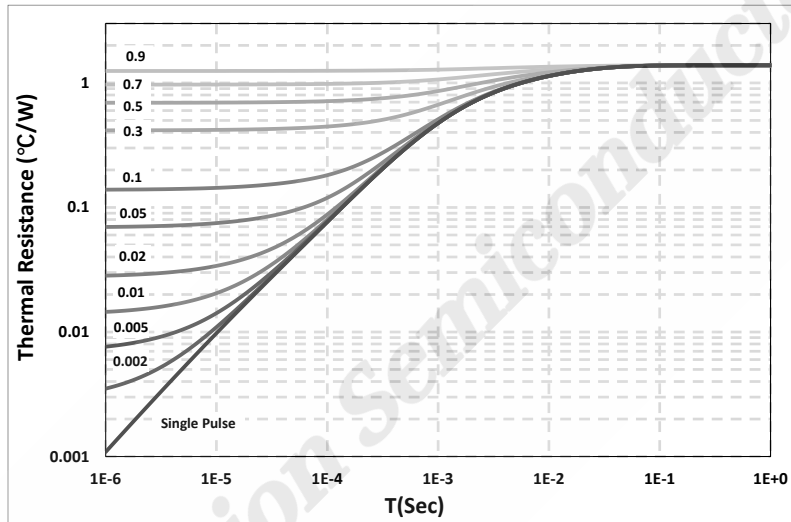
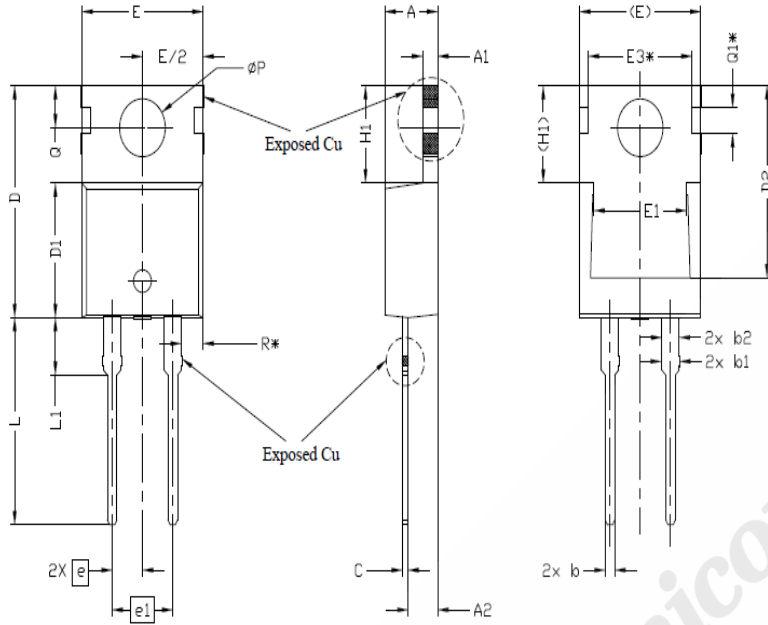

Figure 9. Transient Thermal Impedance

5. Package Outlines



SYMBOL	DIMENSIONS			NOTES
	MIN.	NOM.	MAX.	
A	4.24	4.44	4.64	
A1	1.15	1.27	1.40	
A2	2.30	2.48	2.70	
b	0.70	0.80	0.90	
b1	1.20	1.55	1.75	
b2	1.20	1.45	1.70	
c	0.40	0.50	0.60	
D	14.70	15.37	16.00	4
D1	8.82	8.92	9.02	
D2	12.63	12.73	12.83	5
E	9.96	10.16	10.36	4,5
E1	6.86	7.77	8.89	5
E3*	8.70REF.			
e	2.54BSC			
e1	5.08BSC			
H1	6.30	6.45	6.60	5,6
L	13.47	13.72	13.97	
L1	3.60	3.80	4.00	
$\varnothing P$	3.75	3.84	3.93	
Q	2.60	2.80	3.00	
Q1*	1.73REF.			
R*	1.82REF.			

Drawing and Dimensions

PN Junction Semicore