

LTM4660 High Density Hybrid Step-Down Synchronous Converter

DESCRIPTION

Demonstration circuit 2879A is a high efficiency, high power density hybrid converter. It can deliver 12V/25A with an input voltage from 36V to 60V (up to 65V during transients). This demo board features the **LTM4660**, which uses an architecture that merges soft-switching switched capacitor topology with a traditional step-down converter to provide superior efficiency compared to the traditional switching architectures. It offers a high efficiency/high density and cost effective solution for nonisolated intermediate bus applications in power distribution, datacom and telecom.

Due to its current mode control architecture, multiple LTM4660s can be operated in a parallel, multiphase configuration with excellent current sharing and low output voltage ripple to enable much higher power applications. Other benefits include low EMI emissions due to a soft-switched front end and reduced MOSFET stress.

The LTM4660 design eliminates the inrush current typically associated with switched capacitor circuits by pre-balancing the capacitors on start-up. The LTM4660 also monitors system voltage, current and temperature for faults. It stops switching and pulls the $\overline{\text{FAULT}}$ pin low when a fault condition occurs. An onboard timer can be set for appropriate restart/retry times.

Additional features include $\pm 1.5\%$ output voltage accuracy over temperature, a clock output for multiphase operation, a power good output signal, short-circuit protection, monotonic output voltage start-up, optional external reference, undervoltage lockout and internal charge balance circuitry.

The LTM4660 data sheet must be used in conjunction with this demo board manual.

[Design files for this circuit board are available.](#)

All registered trademarks and trademarks are the property of their respective owners.

BOARD PHOTO

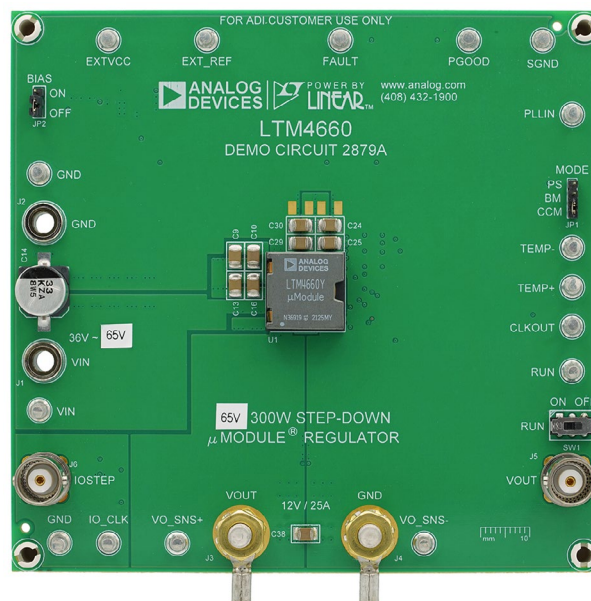

Figure 1. LTM4660/DC2879A Demo Circuit

PERFORMANCE SUMMARY Specifications are at $T_A = 25^\circ\text{C}$

PARAMETER	CONDITION	MIN	TYP	MAX	VALUE
Input Voltage Range		36		60	V
Output Voltage, V_{OUT}	$V_{IN} = 36\text{V to } 60\text{V}$, $I_{OUT} = 0\text{A to } 25\text{A}$			12	V
Maximum Output Current, I_{OUT}	$V_{IN} = 36\text{V to } 60\text{V}$, $V_{OUT} = 12\text{V}$			25	A
Typical Efficiency	$V_{IN} = 48\text{V}$, $V_{OUT} = 12\text{V}$, $I_{OUT} = 25\text{A}$		96.6		%
Peak Efficiency	$V_{IN} = 48\text{V}$, $V_{OUT} = 12\text{V}$		97.0		%
Default Switching Frequency (at Start-Up)			430		kHz

QUICK START PROCEDURE

Demonstration circuit 2879A is easy to set up to evaluate the performance of the LTM4660. Refer to Figure 2 for the proper measurement equipment setup and follow the procedure below.

1. With power off, connect the input power supply to V_{IN} (36V to 60V) and GND (input return).
2. Connect the output load between V_{OUT} and GND (Initial load: no load). Refer to Figure 2.
3. Connect the DVMs to the input and output.
4. Check the default jumper/switch position: SW1 (RUN): OFF.
5. Turn on the input power supply and adjust voltage to 48V.
 NOTE: Make sure that the input voltage does not exceed 60V.
6. Turn on the switches: SW1: ON.
7. Check for the proper output voltages from VO_SNS^+ to VO_SNS^- .
8. Once the proper output voltage is established, adjust the load within the operating range and measure the efficiency, output ripple voltage and other parameters.
9. After completing all tests, adjust the load to 0A, power off the input power supply.

Notes

1. When measuring the output or input voltage ripple, do not use the long ground lead on the oscilloscope probe. See Figure 3 for the proper scope probe technique. Short, stiff leads need to be soldered to the (+) and (-) terminals of an output capacitor. The probe's ground ring needs to touch the (-) lead and the probe tip needs to touch the (+) lead.
2. When doing the load step test with the onboard dynamic load circuit, please make sure the load step-up pulse duty cycle does not exceed 2% and the pulse duration is less than 500 μs so that the temperature of the MOSFETs Q11, Q12 in the dynamic load circuit stay in the safe region. Instead of using the onboard dynamic load circuit, an electric load can also be used for the load step test, which does not have the 2% max duty cycle limit for the load step.
3. The $EXTV_{CC}$ pin is connected by default to V_{OUT} , through a jumper R3. Remove R3 before applying external voltage to $EXTV_{CC}$ pin.
4. Due to the feature of the controller inside LTM4660, it is normal to see increased switching frequency after long-time running, as higher temperature leads to higher switching frequency.

QUICK START PROCEDURE

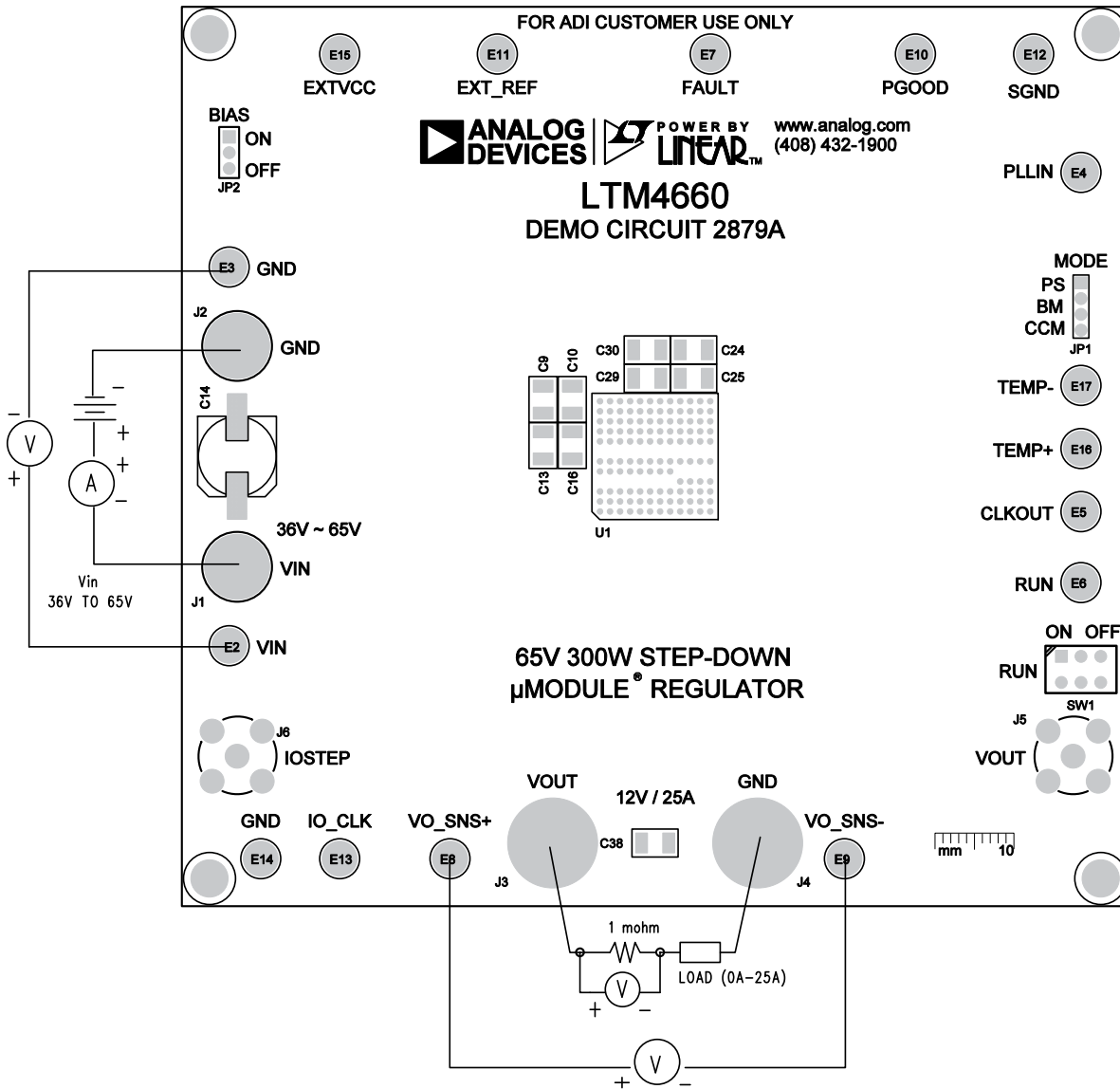

Figure 2. Proper Measurement Equipment Setup

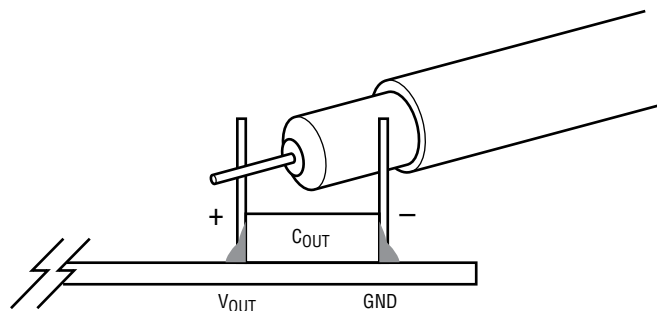

Figure 3. Measuring Output Voltage Ripple

QUICK START PROCEDURE

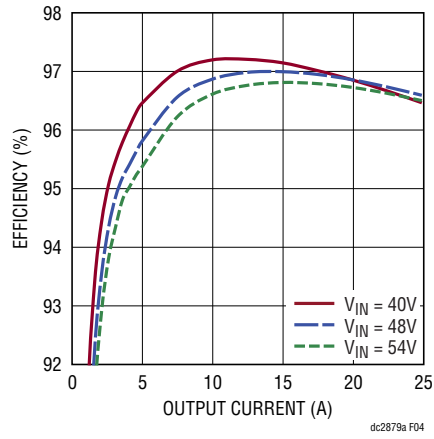

Figure 4. Efficiency vs Load Current at $V_{OUT} = 12V$, $f_{SW} = 430kHz$

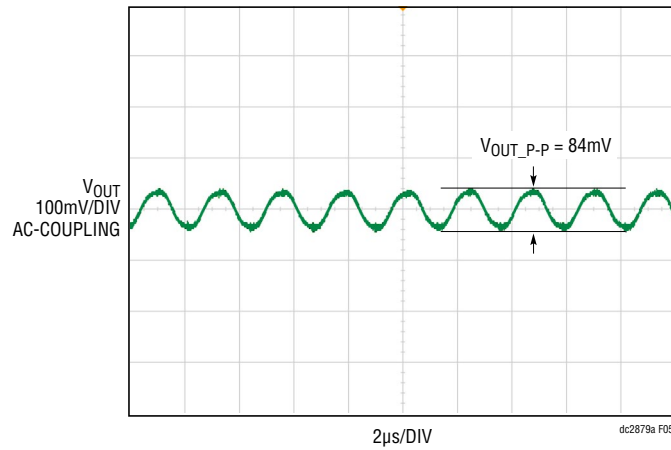

Figure 5. Output Voltage Ripple at $V_{IN} = 48V$, $V_{OUT} = 12V$, $I_{OUT} = 25A$, $f_{SW} = 430kHz$

QUICK START PROCEDURE

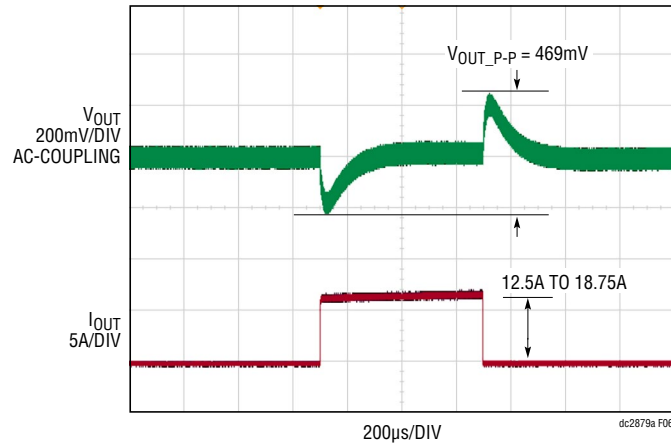

Figure 6. Load Step at $V_{IN} = 48V$, $V_{OUT} = 12V$, $f_{SW} = 430kHz$

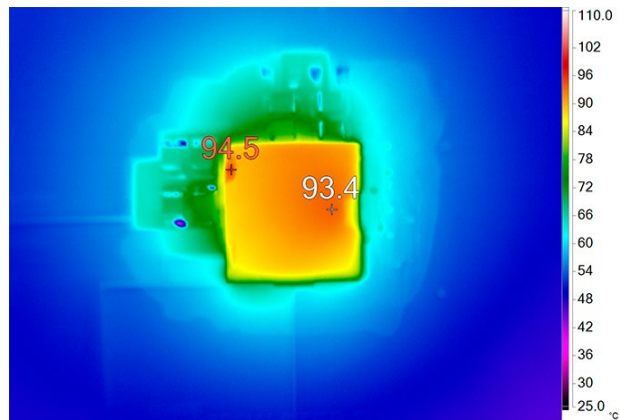

Figure 7. Thermal Performance $V_{IN} = 48V$, $V_{OUT} = 12V$, $I_{OUT} = 25A$, $f_{SW} = 480kHz$, $T_A = 23^{\circ}C$, No Heatsink, No Airflow

DEMO MANUAL

DC2879A

PARTS LIST

ITEM	QTY	REFERENCE	PART DESCRIPTION	MANUFACTURER/PART NUMBER
Required Circuit Components				
1	8	C1, C2, C3, C4, C5, C15, C46, C47	CAP, 2.2 μ F, X7R, 100V, 10%, 1210	AVX 12101C225KAT2A TDK C3225X7R2A225K230AB MURATA GRM32DR72A225KA12K MURATA GRM32DR72A225KA12L
2	23	C7, C8, C9, C10, C11, C12, C13, C16, C19, C20, C24, C25, C26, C27, C28, C29, C30, C32, C33, C34, C38, C39, C40	CAP, 10 μ F, X7S, 100V, 10%, 1210, NO SUBS. ALLOWED	MURATA GRM32EC72A106KE05L
3	1	C14	CAP, 33 μ F, ALUM. ELECT., 80V, 20%, 10x10.2mm SMD, RADIAL, AEC-Q200	PANASONIC EEHZA1K330P
4	1	C21	CAP, 2.2 μ F, X7S, 25V, 10%, 0603	MURATA GRM188C71E225KE11D
5	1	C36	CAP, 0.1 μ F, X7S, 100V, 10%, 0603	TAIYO YUDEN HMK107C7104KA-T TDK C1608X7S2A104K080AB
6	2	C41, C42	CAP, 150 μ F, ALUM./OS-CON, 16V, 20%, 8x6.9mm SMD, RADIAL	PANASONIC 16SVPC150M
7	2	C49, C50	CAP, 22 μ F, X5R, 25V, 10%, 1210	KEMET C1210C226K3PACTU MURATA GRM32ER61E226KE15K MURATA GRM32ER61E226KE15L SAMSUNG CL32A226KAJNNNE TAIYO YUDEN TMK325BJ226KM-P AVX 12103D226KAT2A TAIYO YUDEN TMK325BJ226KM-T
8	1	C51	CAP, 0.047 μ F, X7R, 25V, 10%, 0603	NIC NMC0603X7R473K25TRPF AVX 06033C473KAT2A
9	1	C52	CAP, 220pF, C0G, 50V, 5%, 0603	AVX 06035A221JAT2A MURATA GRM1885C1H221JA01D WURTH ELEKTRONIK 885012006059
10	1	C53	CAP, 1 μ F, X7R, 25V, 10%, 0603, AEC-Q200	MURATA GCM188R71E105KA64D TAIYO YUDEN TMK107AB7105KAHT TDK CGA3E1X7R1E105K080AC
11	1	L3	IND., 68 μ H, PWR, SHIELDED, 20%, 0.62A, 0.42 Ω , 6mm x 6mm SMD	COILCRAFT LPS6225-683MRB COILCRAFT LPS6225-683MRC
12	2	Q11, Q12	XSTR., MOSFET, N-CH, 40V, TO-252 (DPAK)	VISHAY SUD50N04-8M8P-4GE3
13	6	R1, R3, R9, R12, R16, R18	RES., AEC-Q200, 0 Ω , 1/10W, 0603	VISHAY CRCW06030000Z0EA VISHAY CRCW06030000Z0EB NIC NRC06ZOTRF
14	2	R2, R22	RES., AEC-Q200, 20k, 5%, 1/10W, 0603	NIC NRC06J203TRF VISHAY CRCW060320K0JNEA PANASONIC ERJ3GEYJ203V
15	1	R4	RES., AEC-Q200, 1M, 1%, 1/10W, 0603	NIC NRC06F1004TRF PANASONIC ERJ3EKF1004V VISHAY CRCW06031M00FKEA
16	1	R5	RES., 46.4k, 1%, 1/10W, 0603	NIC NRC06F4642TRF VISHAY CRCW060346K4FKEA YAGEO RC0603FR-0746K4L
17	3	R6, R13, R24	RES., AEC-Q200, 10k, 1%, 1/10W, 0603	VISHAY CRCW060310K0FKEA KOA SPEER RK73H1JTDD1002F PANASONIC ERJ3EKF1002V
18	1	R7	RES., 100k, 1%, 1/10W, 0603	VISHAY CRCW0603100KFEA NIC NRC06F1003TRF PANASONIC ERJ3EKF1003V

PARTS LIST

ITEM	QTY	REFERENCE	PART DESCRIPTION	MANUFACTURER/PART NUMBER
19	1	R10	RES., 56.2k, 1%, 1/10W, 0603, AEC-Q200	NIC NRC06F5622TRF PANASONIC ERJ3EKF5622V VISHAY CRCW060356K2FKEA
20	1	R19	RES., AEC-Q200, 4.32k, 1%, 1/10W, 0603	VISHAY CRCW06034K32FKEA NIC NRC06F4321TRF PANASONIC ERJ3EKF4321V
21	1	R21	RES., AEC-Q200, 182k, 1%, 1/10W, 0603	PANASONIC ERJ3EKF1823V VISHAY CRCW0603182KFKEA
22	1	R23	RES., 80.6k, 1%, 1/10W, 0603	VISHAY CRCW060380K6FKEA NIC NRC06F8062TRF YAGEO RC0603FR-0780K6L
23	1	R25	RES., 0.1Ω, 1%, 1W, 2010	VISHAY WSL2010R1000FEA18
24	1	U1	IC, HYBRID STEP-DOWN NON-ISOLATED μModule® BUS CONVERTER	ANALOG DEVICES LTM4660IY#PBF
25	1	U2	IC, SYNCHRONOUS STEP-DOWN CONVERTER	ANALOG DEVICES LTC3630AEMSE#PBF ANALOG DEVICESLTC3630AEMSE#TRPBF

Additional Demo Board Circuit Components

1	0	C17, C18, C23, C31	CAP, OPTION, 1210	
2	0	C35, C37, C43, C44, C45, C48, C54	CAP, OPTION, 0603	
3	0	R8, R14, R15, R17, R20	RES., OPTION, 0603	
4	0	RN1	THERMISTOR, OPTION, 0603	

Hardware: For Demo Board Only

1	16	E2, E3, E4, E5, E6, E7, E8, E9, E10, E11, E12, E13, E14, E15, E16, E17	TEST POINT, TURRET, 0.094", MTG. HOLE	MILL-MAX 2501-2-00-80-00-00-07-0
2	2	J1, J2	CONN., BANANA JACK, FEMALE, THT, NON-INSULATED, SWAGE	KEYSTONE 575-4
3	2	J3, J4	STUD, FASTENER, #10-32	PENN ENGINEERING KFH-032-10ET
4	2	J5, J6	CONN., RF, BNC, RCPT JACK, 5-PIN, STR, THT, 50Ω	AMPHENOL RF 112404
5	2	JLRE1, JLRE2	RING, LUG, CRIMP, #10, NON-INSULATED, SOLDERLESS TERMINALS	KEYSTONE 8205
6	4	JNE1, JNE2, JNE3, JNE4	NUT, HEX, #10-32, BRASS	PENCOM NU1132
7	1	JP1	CONN., HDR, MALE, 1×4, 2mm, STR, THT	WURTH ELEKTRONIK 62000411121
8	1	JP2	CONN., HDR, MALE, 1×3, 2mm, THT, STR, NO SUBS. ALLOWED	WURTH ELEKTRONIK 62000311121
9	2	JWE1, JWE2	WASHER, #10, LOCK, EXT, TIN FINISH	PENCOM WA4526
10	1	LB1	LABEL SPEC, DEMO BOARD SERIAL NUMBER	BRADY THT-96-717-10
11	4	MH1, MH2, MH3, MH4	STANDOFF, NYLON, SNAP-ON, 0.625"	KEYSTONE 8834
12	1	PCB1	PCB, DC2879A	PHASE 3600-DC2879A
13	1	STNCL1	TOOL, STENCIL, DC2879A	ANALOG DEVICES 830-DC2879A
14	1	SW1	SWITCH, SLIDE, DPDT, 0.3A, 6VDC, PTH	C&K JS202011CQN
15	2	XJP1, XJP2	CONN., SHUNT, FEMALE, 2-POS, 2mm	WURTH ELEKTRONIK 60800213421

DEMO MANUAL DC2879A

SCHEMATIC DIAGRAM

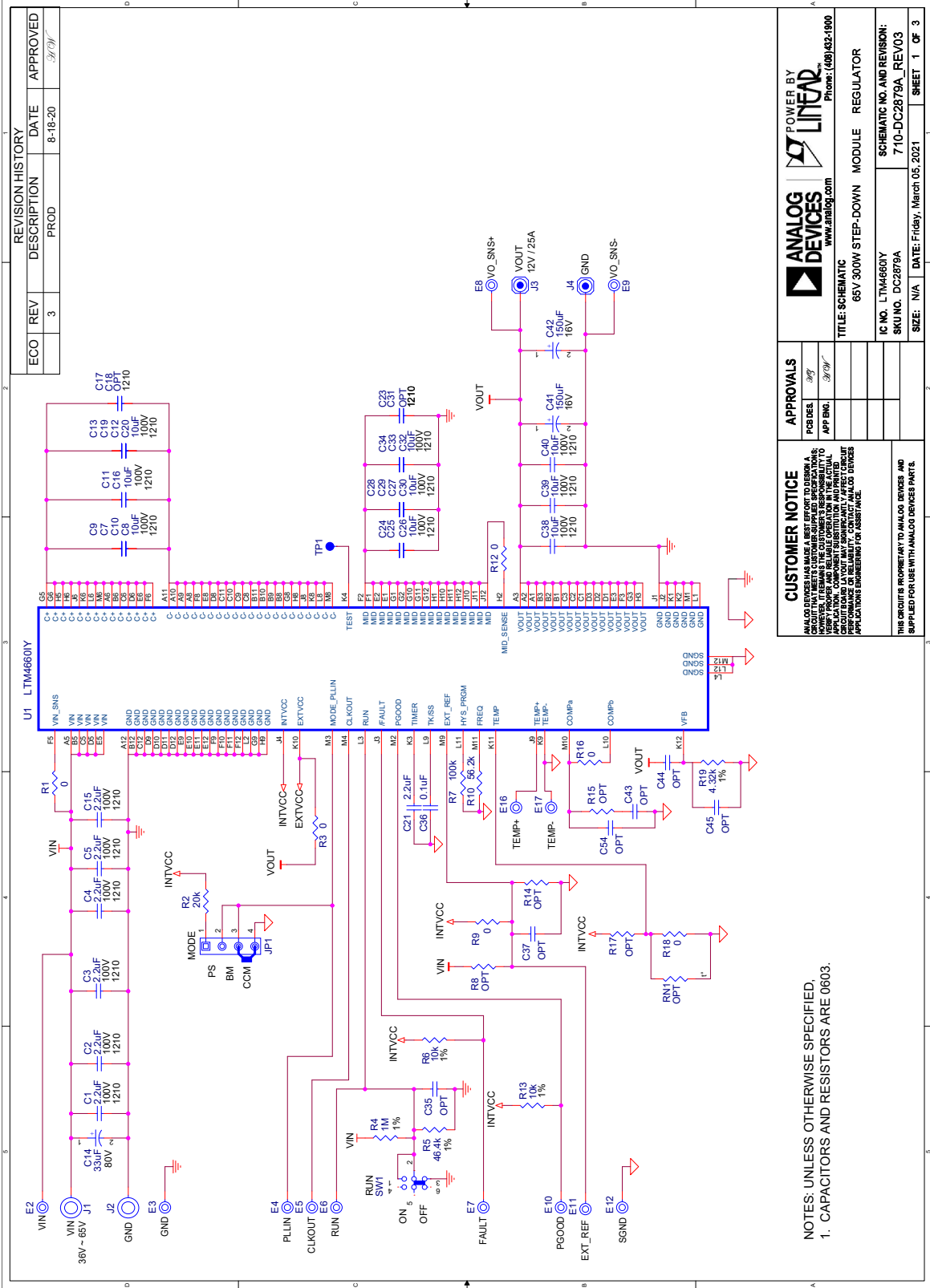

REVISION HISTORY				
ECO	REV	DESCRIPTION	DATE	APPROVED
	3	PROD	8-18-20	BYD



POWER BY
LINEAR
www.linear.com
Phone: (608) 432-1900

REGULATOR

SCHEMATIC NO. AND REVISION:
7-10-DC2879A_REV03

CUSTOMER NOTICE

ANALOG DEVICES AND LINEAR TECHNOLOGY INC. (LTC) PROVIDE THIS SCHEMATIC AS A SERVICE TO OUR CUSTOMERS. THIS SCHEMATIC IS PROVIDED AS-IS AND WITHOUT WARRANTY OF ANY KIND. CUSTOMERS ARE RESPONSIBLE FOR VERIFYING THE ACCURACY OF THIS SCHEMATIC AND FOR OBTAINING NECESSARY PERMITS AND APPROVALS FOR USE IN THEIR APPLICATIONS. COMPONENT SUBSTITUTION AND PRINTED CIRCUIT BOARD MANUFACTURING VARIATIONS MAY AFFECT PERFORMANCE OR RELIABILITY. CONTACT ANALOG DEVICES APPLICATION ENGINEERING FOR ASSISTANCE.

APPROVALS

FOR DESG	BYD
APP ENG	BYD

TITLE: SCHEMATIC
65V 300W STEP-DOWN MODULE REGULATOR

IC NO. LTM4600Y
SKU NO. DC2879A
DATE: Friday, March 05, 2021

THIS CIRCUIT IS PROPRIETARY TO ANALOG DEVICES AND IS SUPPLIED FOR USE WITH ANALOG DEVICES PARTS.

SIZE: N/A
SHEET 1 OF 3

NOTES: UNLESS OTHERWISE SPECIFIED,
1. CAPACITORS AND RESISTORS ARE 0603.

SCHEMATIC DIAGRAM

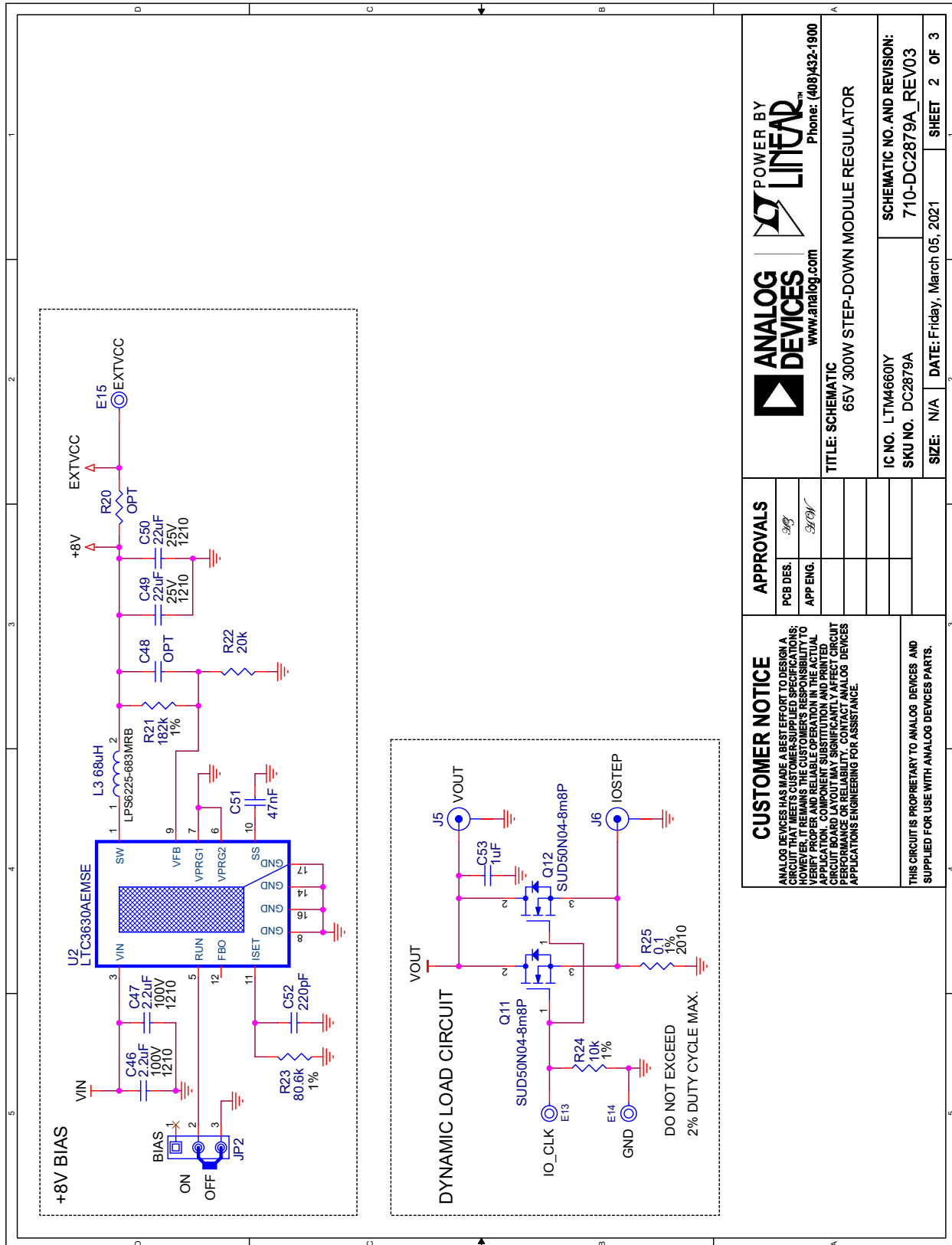

				Phone: (408)432-1900	
				www.analog.com	
APPROVALS				TITLE: SCHEMATIC 65V 300W STEP-DOWN MODULE REGULATOR	
PCB DES.	9/07	IC NO.	LTM4660Y	SCHEMATIC NO. AND REVISION:	
APP ENG.	3/07	SKU NO.	DC2879A	710-DC2879A_REV03	
		SIZE:	N/A	DATE:	Friday, March 05, 2021
				SHEET	2 OF 3
CUSTOMER NOTICE ANALOG DEVICES HAS MADE A BEST EFFORT TO DESIGN A CIRCUIT THAT MEETS CUSTOMER-SUPPLIED SPECIFICATIONS; HOWEVER, IT REMAINS THE CUSTOMER'S RESPONSIBILITY TO VERIFY THAT THE CIRCUIT MEETS ALL REQUIREMENTS FOR THE INTENDED APPLICATION. COMPONENT SUBSTITUTION AND PRINTED CIRCUIT BOARD LAYOUT MAY SIGNIFICANTLY AFFECT CIRCUIT PERFORMANCE OR RELIABILITY. CONTACT ANALOG DEVICES APPLICATIONS ENGINEERING FOR ASSISTANCE.				THIS CIRCUIT IS PROPRIETARY TO ANALOG DEVICES AND SUPPLIED FOR USE WITH ANALOG DEVICES PARTS.	





ESD Caution

ESD (electrostatic discharge) sensitive device. Charged devices and circuit boards can discharge without detection. Although this product features patented or proprietary protection circuitry, damage may occur on devices subjected to high energy ESD. Therefore, proper ESD precautions should be taken to avoid performance degradation or loss of functionality.

Legal Terms and Conditions

By using the evaluation board discussed herein (together with any tools, components documentation or support materials, the "Evaluation Board"), you are agreeing to be bound by the terms and conditions set forth below ("Agreement") unless you have purchased the Evaluation Board, in which case the Analog Devices Standard Terms and Conditions of Sale shall govern. Do not use the Evaluation Board until you have read and agreed to the Agreement. Your use of the Evaluation Board shall signify your acceptance of the Agreement. This Agreement is made by and between you ("Customer") and Analog Devices, Inc. ("ADI"), with its principal place of business at One Technology Way, Norwood, MA 02062, USA. Subject to the terms and conditions of the Agreement, ADI hereby grants to Customer a free, limited, personal, temporary, non-exclusive, non-sublicensable, non-transferable license to use the Evaluation Board FOR EVALUATION PURPOSES ONLY. Customer understands and agrees that the Evaluation Board is provided for the sole and exclusive purpose referenced above, and agrees not to use the Evaluation Board for any other purpose. Furthermore, the license granted is expressly made subject to the following additional limitations: Customer shall not (i) rent, lease, display, sell, transfer, assign, sublicense, or distribute the Evaluation Board; and (ii) permit any Third Party to access the Evaluation Board. As used herein, the term "Third Party" includes any entity other than ADI, Customer, their employees, affiliates and in-house consultants. The Evaluation Board is NOT sold to Customer; all rights not expressly granted herein, including ownership of the Evaluation Board, are reserved by ADI. CONFIDENTIALITY. This Agreement and the Evaluation Board shall all be considered the confidential and proprietary information of ADI. Customer may not disclose or transfer any portion of the Evaluation Board to any other party for any reason. Upon discontinuation of use of the Evaluation Board or termination of this Agreement, Customer agrees to promptly return the Evaluation Board to ADI. ADDITIONAL RESTRICTIONS. Customer may not disassemble, decompile or reverse engineer chips on the Evaluation Board. Customer shall inform ADI of any occurred damages or any modifications or alterations it makes to the Evaluation Board, including but not limited to soldering or any other activity that affects the material content of the Evaluation Board. Modifications to the Evaluation Board must comply with applicable law, including but not limited to the RoHS Directive. TERMINATION. ADI may terminate this Agreement at any time upon giving written notice to Customer. Customer agrees to return to ADI the Evaluation Board at that time. LIMITATION OF LIABILITY. THE EVALUATION BOARD PROVIDED HEREUNDER IS PROVIDED "AS IS" AND ADI MAKES NO WARRANTIES OR REPRESENTATIONS OF ANY KIND WITH RESPECT TO IT. ADI SPECIFICALLY DISCLAIMS ANY REPRESENTATIONS, ENDORSEMENTS, GUARANTEES, OR WARRANTIES, EXPRESS OR IMPLIED, RELATED TO THE EVALUATION BOARD INCLUDING, BUT NOT LIMITED TO, THE IMPLIED WARRANTY OF MERCHANTABILITY, TITLE, FITNESS FOR A PARTICULAR PURPOSE OR NON-INFRINGEMENT OF INTELLECTUAL PROPERTY RIGHTS. IN NO EVENT WILL ADI AND ITS LICENSORS BE LIABLE FOR ANY INCIDENTAL, SPECIAL, INDIRECT, OR CONSEQUENTIAL DAMAGES RESULTING FROM CUSTOMER'S POSSESSION OR USE OF THE EVALUATION BOARD, INCLUDING BUT NOT LIMITED TO LOST PROFITS, DELAY COSTS, LABOR COSTS OR LOSS OF GOODWILL. ADI'S TOTAL LIABILITY FROM ANY AND ALL CAUSES SHALL BE LIMITED TO THE AMOUNT OF ONE HUNDRED US DOLLARS (\$100.00). EXPORT. Customer agrees that it will not directly or indirectly export the Evaluation Board to another country, and that it will comply with all applicable United States federal laws and regulations relating to exports. GOVERNING LAW. This Agreement shall be governed by and construed in accordance with the substantive laws of the Commonwealth of Massachusetts (excluding conflict of law rules). Any legal action regarding this Agreement will be heard in the state or federal courts having jurisdiction in Suffolk County, Massachusetts, and Customer hereby submits to the personal jurisdiction and venue of such courts. The United Nations Convention on Contracts for the International Sale of Goods shall not apply to this Agreement and is expressly disclaimed.