

Connector Type

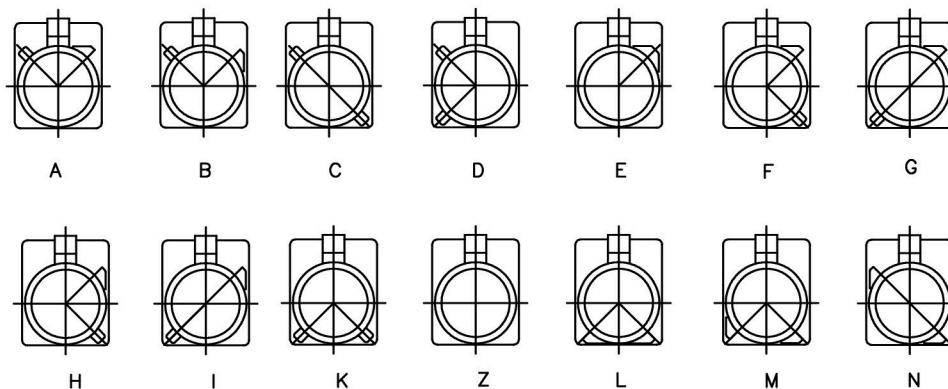

Type	Color	Serial No.
A	BLACK (黑色)	10-53-1-0123
B	WHITE (白色)	10-53-1-0122
C	BLUE (蓝色)	10-53-1-0077
D	BORDEAUX VIOLET (紫红色)	10-53-1-0078
E	GREEN (军绿色)	10-53-1-0079
F	BROWN (棕褐色)	
G	GREY (灰色)	
H	VIOLET (粉红色)	
I	BEIGE (米黄色)	
K	CURRY (土黄色)	
Z	WATER BLUE (水蓝色)	10-53-1-0308
L	CARMINE RED (桔红色)	
M	PASTEL ORANGE (橙色)	
N	PASTEL GREEN (浅绿色)	

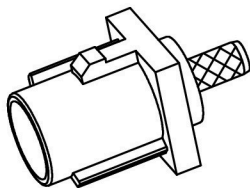
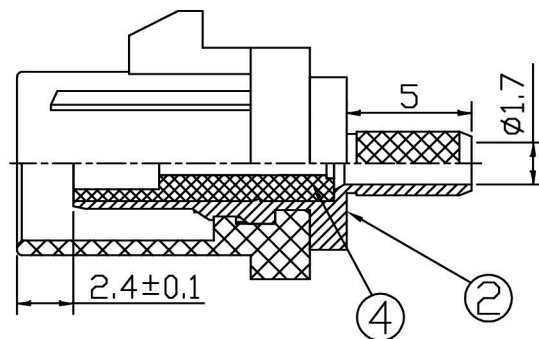

Scale: 1:2

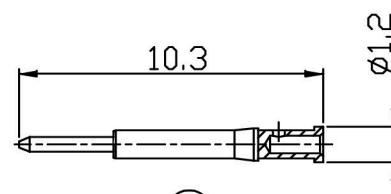

③

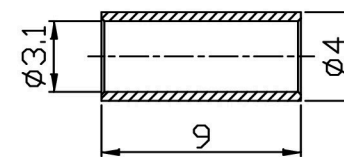

⑤

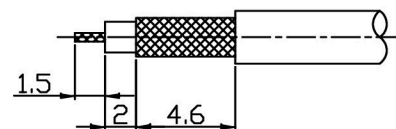

Suggested cable stripping

No.	Name	Material	Remarks	Qty
8				
7				
6				
5	Copper pipe	CU	Nickel plating	1
4	Insulator	PTFE		1
3	Center pin	Brass	Gold plating	1
2	Metal shell	Brass	Nickel plating	1
1	Plastic Shell	PA66+30%GF		1

Tolerance		
0-6mm	±0.1	χ° ±1°
6-18mm	±0.15	χ.X° ±0.1°
18-30mm	±0.2	χ.XX° ±0.05°
30-50mm	±0.25	
50-80mm	±0.35	
80-120mm	±0.50	
120-180mm	±0.65	
180-250mm	±0.90	



Zhejiang JC Antenna Co.,Ltd

FAKRA Male Straight

Drawing No. LJQ281

Rev. C

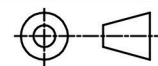

重量: 比例:

For Cable RG174/RG316

ROHS

姓名 日期

制图 俞超 2016/02/26

审核 傅胜明 2016/02/26

批准 陈小忠 2016/02/26