

Sensor/actuator cable - SAC-3P- 5,0-542/M8 FS SH BK - 1406062

Please be informed that the data shown in this PDF Document is generated from our Online Catalog. Please find the complete data in the user's documentation. Our General Terms of Use for Downloads are valid (<http://phoenixcontact.com/download>)



Sensor/actuator cable, 3-position, PVC, yellow, shielded, free cable end, on Socket straight M8, cable length: 5 m



Key Commercial Data

| | |
|------------------------|---|
| Packing unit | 1 pc |
| Minimum order quantity | 50 pc |
| GTIN |  4 046356 799850 |
| GTIN | 4046356799850 |

Technical data

Dimensions

| | |
|-----------------|-----|
| Length of cable | 5 m |
|-----------------|-----|

Ambient conditions

| | |
|---------------------------------|----------------------------------|
| Ambient temperature (operation) | -25 °C ... 90 °C (Plug / socket) |
| Degree of protection | IP65/IP67 |

General

| | |
|------------------------------|------------------------------|
| Rated current at 40°C | 4 A |
| Rated voltage | 48 V AC 60 V DC |
| Number of positions | 3 |
| Color handle area | black |
| Insulation resistance | ≥ 100 MΩ |
| Coding | A - standard |
| Standards/regulations | M8 connector IEC 61076-2-104 |
| Status display | No |
| Protective circuit/component | unwired |
| Overvoltage category | II |

Sensor/actuator cable - SAC-3P- 5,0-542/M8 FS SH BK - 1406062

Technical data

General

| | |
|-----------------------------|------------------------|
| Degree of pollution | 3 |
| Insertion/withdrawal cycles | ≥ 100 |
| Torque | 0.2 Nm (M8 connectors) |

Material

| | |
|--|---|
| Flammability rating according to UL 94 | HB |
| Contact material | CuSn |
| Contact surface material | Ni/Au |
| Contact carrier material | TPU GF |
| Material of grip body | TPU, hardly inflammable, self-extinguishing |
| Material, knurls | Zinc die-cast, nickel-plated |
| Sealing material | NBR |

Standards and Regulations

| | |
|--|-----------------|
| Standard designation | M8 connector |
| Standards/regulations | IEC 61076-2-104 |
| Flammability rating according to UL 94 | HB |

Cable

| | |
|---|---|
| Cable type | PVC yellow 105 °C |
| Cable type (abbreviation) | 542 |
| UL AWM style | 2517 (105 °C / 300 V) |
| AWG signal line | 24 |
| Conductor structure signal line | 32x 1.10 mm |
| Core diameter including insulation | 1.12 mm ±0.03 mm |
| Wire colors | brown, blue, black |
| Overall twist | 3 wires, twisted |
| Shielding | Tinned copper braided shield |
| Optical shield covering | 85 % |
| External sheath, color | yellow |
| External cable diameter D | 4.7 mm ±0.2 mm |
| Minimum bending radius, flexible installation | 12 x D |
| Cable weight | 33 kg/km |
| Outer sheath, material | PVC |
| Material conductor insulation | PVC |
| Conductor material | Tin-plated Cu litz wires |
| Insulation resistance | ≥ (550 M Ohms/m @ 500V) |
| Conductor resistance | max. 79.7 Ω/km (20 °C) |
| Nominal voltage, cable | 300 V |
| Flame resistance | FT4 |
| Other resistance | UV resistant |
| Ambient temperature (operation) | -30 °C ... 105 °C (cable, fixed installation) |

Sensor/actuator cable - SAC-3P- 5,0-542/M8 FS SH BK - 1406062

Technical data

Cable

| | |
|--|---|
| | -5 °C ... 105 °C (cable, flexible installation) |
|--|---|

Environmental Product Compliance

| | |
|------------|---|
| REACH SVHC | Lead 7439-92-1 |
| China RoHS | Environmentally Friendly Use Period = 50 |
| | For details about hazardous substances go to tab "Downloads", Category "Manufacturer's declaration" |

Drawings

Dimensional drawing

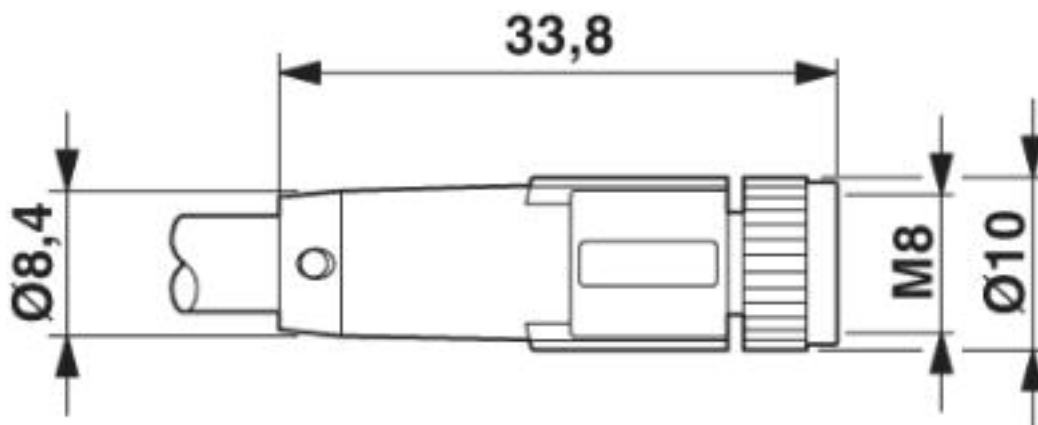

Socket M8 x 1, straight, shielded

Circuit diagram

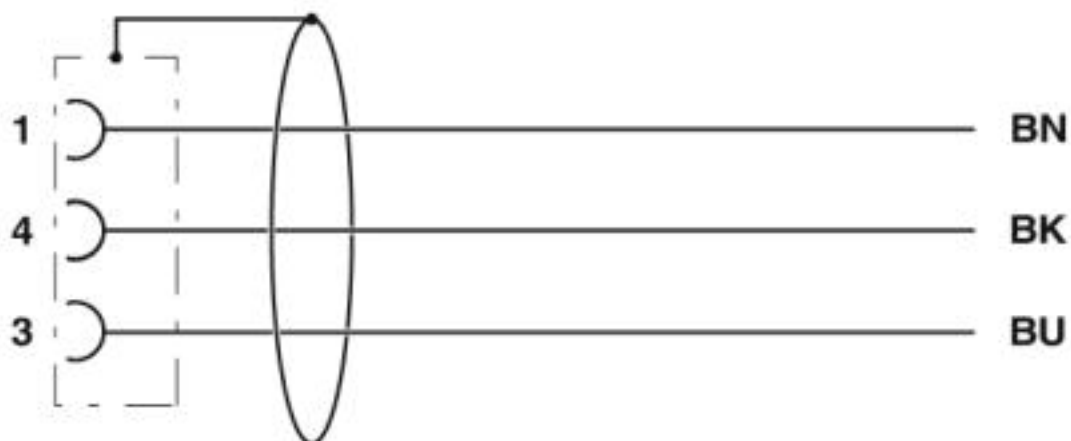

Contact assignment of M8 socket

Sensor/actuator cable - SAC-3P- 5,0-542/M8 FS SH BK - 1406062

Schematic diagram

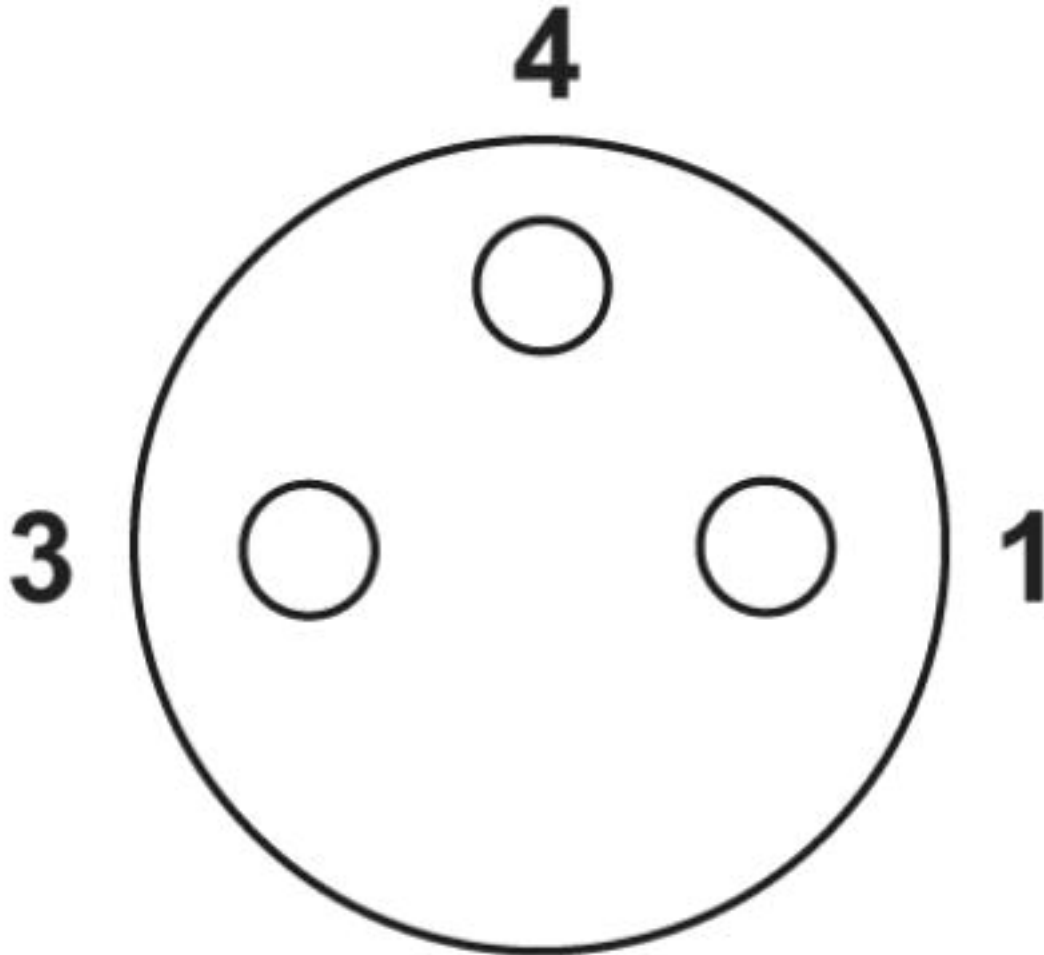

Pin assignment M8 socket, 3-pos., view female side

Sensor/actuator cable - SAC-3P- 5,0-542/M8 FS SH BK - 1406062

Cable cross section

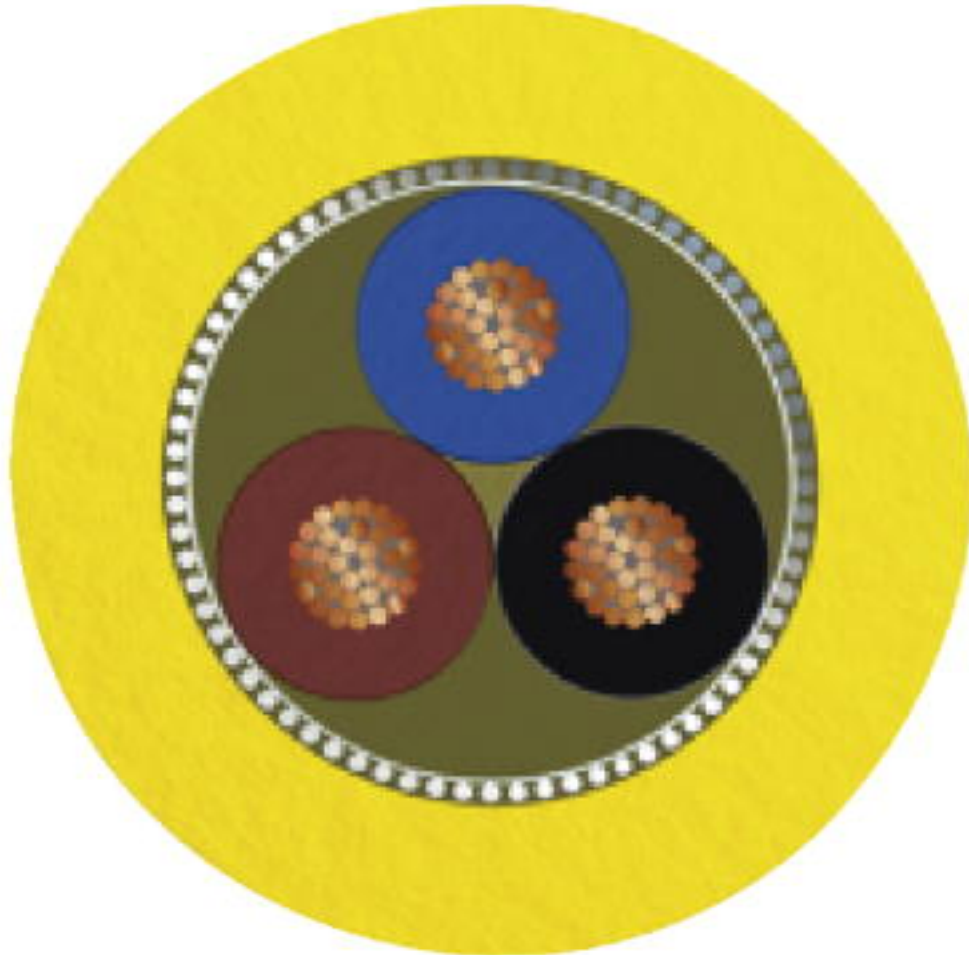

PVC yellow 105 °C [542]

Approvals

Approvals

Approvals

UL Listed / cUL Listed / EAC / cULus Listed

Ex Approvals

Approval details

Sensor/actuator cable - SAC-3P- 5,0-542/M8 FS SH BK - 1406062

Approvals

| | | | |
|--------------------|---|---|---------------|
| UL Listed |  | http://database.ul.com/cgi-bin/XYV/template/LISEXT/1FRAME/index.htm | FILE E 221474 |
| Nominal voltage UN | | 125 V | |
| Nominal current IN | | 4 A | |

| | | | |
|--------------------|---|---|---------------|
| cUL Listed |  | http://database.ul.com/cgi-bin/XYV/template/LISEXT/1FRAME/index.htm | FILE E 221474 |
| Nominal voltage UN | | 125 V | |
| Nominal current IN | | 4 A | |

| | | |
|-----|--|--------------------------|
| EAC |  | RU C- DE.BL08.B.00286 |
|-----|--|--------------------------|

| | |
|--------------|---|
| cULus Listed |  |
|--------------|---|

Phoenix Contact 2019 © - all rights reserved
<http://www.phoenixcontact.com>

PHOENIX CONTACT GmbH & Co. KG
 Flachsmarktstr. 8
 32825 Blomberg
 Germany
 Tel. +49 5235 300
 Fax +49 5235 3 41200
<http://www.phoenixcontact.com>