

THIS IS A C.A.D. GENERATED DRAWING
DO NOT MAKE MANUAL REVISIONS TO MASTER.

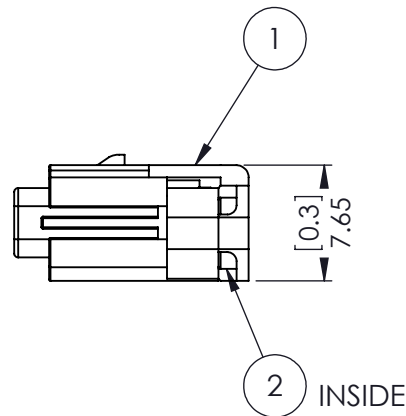

ISSUE NUMBER

ORIGINAL ①

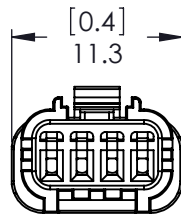
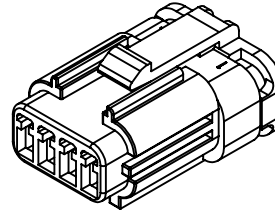
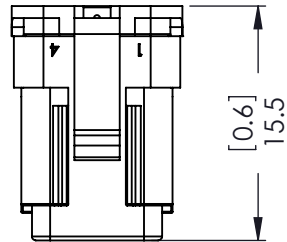

MATERIALS:

1. HOUSING: PBT, UL94V-0
2. WIRE-HOUSING SEAL: SILICON RUBBER

SPECIFICATIONS:

1. PITCH: 2.0MM
2. RATED VOLTAGE: 250V
3. RATED CURRENT: 2A MAX
4. WITHSTAND VOLTAGE: AC 1000V R.M.S.
5. CONTACT RESISTANCE: 10 mOHMS MAX
6. INSULATION RESISTANCE:
1000 MOHMS MIN/DC 500V
7. TEMPERATURE RANGE: -40°C ~ +105°C
8. WATERPROOF GRADE: TESTED AND
CERTIFIED TO IP67

ITEM NO.	DESCRIPTION	QTY.
1	566-004-000-810_Housing	1
2	566-004-000-810_Rubber	1

566 SERIES 4 SOCKET WATERPROOF CONNECTOR

ACAD REFERENCE NO. 566 ASSEMBLY

DRAWN:R.STA.MONICA DATE: NOV.02/10

CHECKED: DATE:

SCALE: NOT TO SCALE SHEET 1 OF 1

DRAWING NUMBER ISSUE

566-004-000-810

1



EDAC INC
TORONTO, ONTARIO
CANADA

YOUR CONNECTION TO QUALITY & SERVICE

THESE DRAWINGS AND SPECIFICATIONS
ARE THE PROPERTY OF EDAC INC. AND
SHALL NOT BE REPRODUCED, OR COPIED
OR USED AS THE BASIS FOR THE
MANUFACTURE OR SALE OF APPARATUS
WITHOUT WRITTEN PERMISSION.



THIS SERIES FULLY CONFORMS TO THE
EUROPEAN UNION DIRECTIVES 2002/95/EC
AND 2002/96/EC FOR RoHS COMPLIANCY