



AMB-50
5000V Insulation Resistance
Tester

Users Manual

- Mode d'emploi
- Bedienungshandbuch
- Manual d'Uso
- Manual de uso



AMB-50

5000V Insulation Resistance Tester

Users Manual

English

Limited Warranty and Limitation of Liability

Your Amprobe product will be free from defects in material and workmanship for 1 year from the date of purchase. This warranty does not cover fuses, disposable batteries or damage from accident, neglect, misuse, alteration, contamination, or abnormal conditions of operation or handling. Resellers are not authorized to extend any other warranty on Amprobe's behalf. To obtain service during the warranty period, return the product with proof of purchase to an authorized Amprobe Test Tools Service Center or to an Amprobe dealer or distributor. See Repair Section for details. THIS WARRANTY IS YOUR ONLY REMEDY. ALL OTHER WARRANTIES - WHETHER EXPRESS, IMPLIED OR STATUTORY - INCLUDING IMPLIED WARRANTIES OF FITNESS FOR A PARTICULAR PURPOSE OR MERCHANTABILITY, ARE HEREBY DISCLAIMED. MANUFACTURER SHALL NOT BE LIABLE FOR ANY SPECIAL, INDIRECT, INCIDENTAL OR CONSEQUENTIAL DAMAGES OR LOSSES, ARISING FROM ANY CAUSE OR THEORY. Since some states or countries do not allow the exclusion or limitation of an implied warranty or of incidental or consequential damages, this limitation of liability may not apply to you.

Repair

All test tools returned for warranty or non-warranty repair or for calibration should be accompanied by the following: your name, company's name, address, telephone number, and proof of purchase. Additionally, please include a brief description of the problem or the service requested and include the test leads with the meter. Non-warranty repair or replacement charges should be remitted in the form of a check, a money order, credit card with expiration date, or a purchase order made payable to Amprobe® Test Tools.

In-Warranty Repairs and Replacement – All Countries

Please read the warranty statement and check your battery before requesting repair. During the warranty period any defective test tool can be returned to your Amprobe® Test Tools distributor for an exchange for the same or like product. Please check the "Where to Buy" section on www.amprobe.com for a list of distributors near you. Additionally, in the United States and Canada In-Warranty repair and replacement units can also be sent to a Amprobe® Test Tools Service Center (see address below).

Non-Warranty Repairs and Replacement – US and Canada

Non-warranty repairs in the United States and Canada should be sent to a Amprobe® Test Tools Service Center. Call Amprobe® Test Tools or inquire at your point of purchase for current repair and replacement rates.

In USA

Amprobe Test Tools

Everett, WA 98203

Tel: 877-AMPROBE (267-7623)

In Canada

Amprobe Test Tools

Mississauga, ON L4Z 1X9

Tel: 905-890-7600

Non-Warranty Repairs and Replacement – Europe

European non-warranty units can be replaced by your Amprobe® Test Tools distributor for a nominal charge. Please check the "Where to Buy" section on www.amprobe.com for a list of distributors near you.

European Correspondence Address*

Amprobe® Test Tools Europe

In den Engematten 14

79286 Glottertal, Germany

Tel.: +49 (0) 7684 8009 - 0

*(Correspondence only – no repair or replacement available from this address. European customers please contact your distributor.)

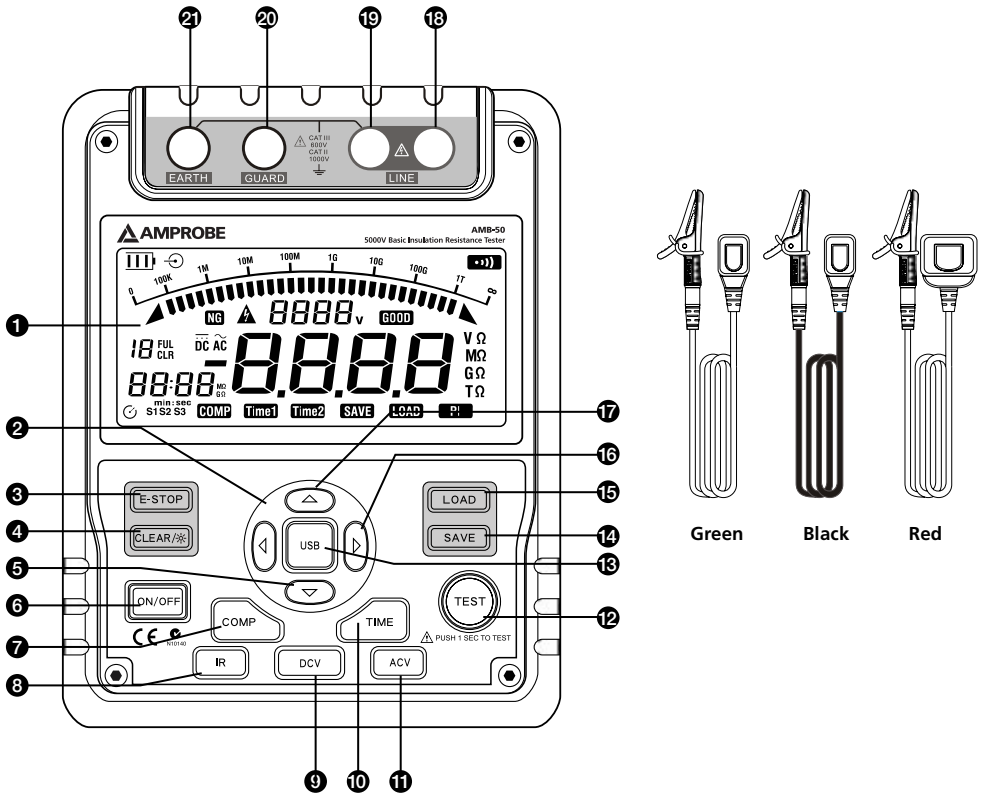

- ❶ LCD
- ❷ ◀ Scroll Button
- ❸ Emergency Stop
- ❹ Data Clear the Display Backlight Button
- ❺ ▼ Down Button
- ❻ On/Off Button
- ❼ Compare Button
- ❽ Insulation Resistance Button
- ❾ DC Voltages measurement Button
- ❿ Timer Button.
- ⓫ AC Voltages measurement Button
- ⓬ Test Button
- ⓭ USB Button
- ⓮ Data Store Button.
- ⓯ Data Recall Button
- ⓰ ▶ Scroll Button

- ⓱ ▲Up Button
- ⓲ LINE: High Voltage output input terminal
(two plugs red test lead to one alligator clip)
- ⓳ High voltage line shielding input terminal
(two plugs red test lead to one alligator clip)
- ⓴ GUARD: Grounding protection input terminal
(one plug black test lead to one alligator clip)
- ⓵ EARTH: High resistance measurement input terminal
(one plug green test lead to one alligator clip)
- ⓶ Testing leads:
Two plugs red test lead to one alligator clip.
One plug black test lead to one alligator clip.
One plug green test lead to one alligator clip.

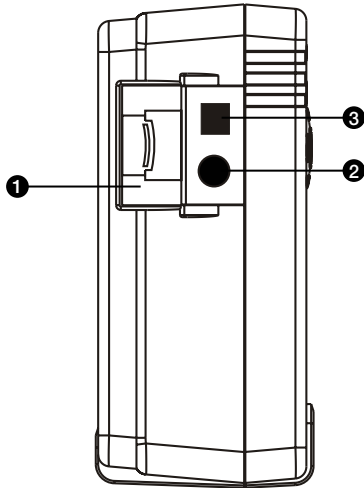

- ① Safety Shutter
- ② Power adaptor Input Terminal
- ③ USB Port

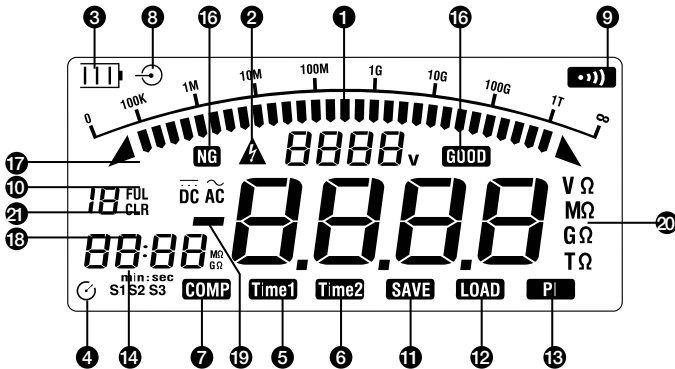

- ① Indicator for DC voltage
- ② Indicator for data store full
- ③ Indicator for clearing
- ④ Indicator for AC voltage
- ⑤ Indicator for timer
- ⑥ Step symbol
- ⑦ Indicates selected pass/fail compare value
- ⑧ Indicates for negative reading
- ⑨ Timer 1 symbol
- ⑩ Timer 2 symbol
- ⑪ Data store is on
- ⑫ Data recall is on
- ⑬ Indicator for polarization index
- ⑭ Unit symbols
- ⑮ The continuity buzzer is on
- ⑯ Compare feature pass
- ⑰ Analogue bar graph
- ⑱ Risk of electric shock
- ⑲ Compare feature fail
- ⑳ Indicator for power adaptor
- ㉑ Battery life indicator

CONTENTS

SYMBOLS AND WARNINGS2
 Symbols2

UNPACKING AND INSPECTION2

INTRODUCTION2

SAFETY INFORMATION3

OPERATION4
 Key Functions4

MEASUREMENT OPERATION5
 A.Measuring Voltages5
 B.Measuring Insulation Resistance6
 Information.....7
 The Use of Power Adaptor.....8
 USB Interface8
 Battery Saver (Sleep Mode).....9
 Battery Indication9













SPECIFICATIONS.....9

PHYSICAL SPECIFICATIONS9
 General Specifications9
 Feature Summary.....10
 Detailed Accuracy Specifications10

MAINTENANCE AND REPAIR11
 Replacing the Battery.....12

SYMBOLS AND WARNINGS

SYMBOLS

	Battery		Refer to the manual
	Double Insulated		Dangerous Voltage
	Alternating Current		Earth Ground
	Direct Current		Symbol
	Application around and removal from hazardous live conductors is permitted		Complies with EU directives
	Do not dispose of this product as unsorted municipal waste		Conform to relevant Australian standards

UNPACKING AND INSPECTION

Your shipping carton should include:

- 1 AMB-50 Insulation Resistance Tester
- 1 Test Leads (1 set)
- 1 Test Probe (1 set)
- 1 Plug type test Lead with Alligator clip (Green)
- 1 Plug type test Lead with Alligator clip (Black)
- 1 Two Plugs type test lead with Alligator clip (Red)
- 8 Batteries (1.5V, LR14)
- 1 Users Manual
- 1 Tool Box
- 1 Software
- 1 USB Cable
- 1 Power adaptor

If any of the items are damaged or missing, return the complete package to the place of purchase for an exchange.

INTRODUCTION

AMPROBE, AMB-50 insulation resistance tester is a handheld instrument designed primarily to make resistance/ insulation resistance measurement.

SAFETY INFORMATION

This Meter complies with the standards IEC61010 safety measurement requirement: in pollution degree 2, overvoltage category (CAT. III 600V) and double insulation.

CAT II: Local level, appliance, PORTABLE EQUIPMENT etc., with smaller transient voltage overvoltages than CAT. III

Use the Meter only as specified in this operating manual, otherwise the protection provided by the Meter may be impaired.

⚠ DANGER! - identifies conditions and actions that pose hazard(s) to the user

⚠ WARNING! - identifies avoiding electric shock.

⚠ CAUTION! - identifies conditions and actions that may damage the Meter and carrying out accurate measurement.

⚠ DANGER!

Use of instrument in a manual not specified by the manufacturer may impair safety features/ protection provided by the equipment. Read the following safety information carefully before using or servicing the instrument.

- Do not apply more than 600V.
- Do not use the Meter around explosive gas, vapor or dust.
- Do not use the Meter in a wet environment.
- When using the test leads, keep your fingers away from the lead contacts. Keep your fingers behind the finger guards on the leads.
- Do not use the Meter with any parts or cover removed.
- When carrying out insulation measurement, do not contact the circuit under test.

⚠ WARNING!

- Do not use the Meter if it is damaged or metal part is exposed. Look for cracks or missing plastic.
- Be careful when working above 33V rms, 46.7V ac rms or 70V DC. Such voltages pose a shock hazard.
- Discharge all loading of circuit under test after measuring high voltage.
- Do not change battery when the Meter is in wet environment.
- Place test leads in proper input terminals. Make sure all the test leads are firmly connected to the Meter's input terminals.
- Make sure the Meter is turned off when opening the battery compartment.

⚠ CAUTION!

- When performing resistance tests, remove all power from the circuit to be measured and discharge all the power.
- When servicing the Meter, use only the same model number or identical electrical specifications of test leads and power adaptor.
- Do not use the Meter if the battery indicator () shows a battery empty condition. Take the battery out from the Meter if it is not used for a long time.
- Do not use or store the Meter in an environment of high temperature, humidity, explosive, inflammable and strong magnetic field. The performance of the Meter may deteriorate after dampened.
- Soft cloth and mild detergent should be used to clean the surface of the Meter when servicing. No abrasive and solvent should be used to prevent the surface of the Meter from corrosion, damage and accident.
- Dry the Meter before storing if it is wet

OPERATION

Key Functions

ON/OFF	Turn on or off the Meter. Press and hold the button for 1 second to turn the Meter on. Press again to turn off the Meter. The Meter default range is 500V insulation resistance continuous measurement when turning on.
E-STOP	Emergency stop button. Press this button when the Meter is hang and cannot turn off the power.
CLEAR / *	Press to turn on or off the display backlight Press and hold to clear the stored data
SAVE	Press to store the current measurement value. The maximum number of stored reading is 18. When the stored readings memory is full, the Meter shows FULL and stop storing. Press and hold CLEAR / * to clear the stored value in order to store the next measurement

	value.
LOAD	<ul style="list-style-type: none"> Press once to recall the first stored value. Press again to exit Load feature. Load feature can only be used when there is no high voltage output.
▲	<ul style="list-style-type: none"> When the insulation resistance measurement has no testing voltage output, press to select one voltage range up. Under load mode: press to recall the previous stored value.
▼	<ul style="list-style-type: none"> When the insulation resistance measurement has no testing voltage output, press to select one voltage range down. Under load mode: press to recall the next stored value.
◀	<ul style="list-style-type: none"> When set the timer duration for the measurement of insulation resistance or polarization index, press to decrement the time. The maximum length of time is 15 minutes and 30 seconds, the Meter will automatically carry out measurement. When compare feature measuring insulation resistance, press to decrement a resistance comparing value. After polarization index measurement, press to display polarization index, TIME 2 insulation resistance value and TIME 1 insulation resistance value in sequence.
▶	<ul style="list-style-type: none"> When set the timer duration for the measurement of insulation resistance or polarization index, press to increment the time. The maximum length of time is 30 minutes and 30 seconds, the Meter will automatically carry out measurement. When use the compare feature measuring insulation resistance, press to increment a resistance comparing value. After polarization index measurement, press to display polarization index, TIME 2 insulation resistance value and TIME 1 insulation resistance value in sequence.
USB	<ul style="list-style-type: none"> Press once to start the data transferring to the computer via USB, USB symbol shows on the display. Press again to stop the data transferring to the computer via USB, USB symbol disappears.
COMP	Set a pass / fail limit for insulation tests. The default value is 10M
TIME	Pres to step through continuous measurement, timed measurement and polarization index measurement in sequence.
TEST	Press to stop or start an insulation resistance test
IR	Press to initiate insulation resistance measurement
DCV	Press to initiate DC voltage measurement
ACV	Pres to initiate AC voltage measurement

MEASUREMENT OPERATION

Below section explains how to make measurements.

Press and hold ON/OFF to turn on the Meter, press again to turn off the Meter. The Meter default range is 500V insulation resistance continuous measurement when turning on.

A. Measuring Voltages

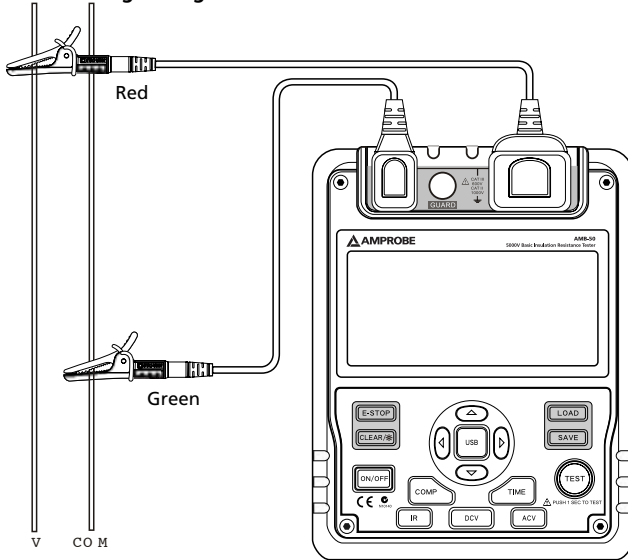

⚠ OPERATING CAUTION!

- To avoid harms to you or damages to the Meter, please do not attempt to measure voltages higher than 600V or 600V rms, although readings may be obtained.
- Special care should be taken when measuring high voltage.

To measure voltages, set up the Meter as Figure 4 and do the following:

1. Press DCV or ACV button to select DC voltage or AC voltage measurement
2. Insert the red and green test lead into the tested circuit.
3. When measuring DC voltage, if the red test lead is negative voltage, i-i symbol will show on the display.

Note

- When voltage measurement has been completed, disconnect the connection between the testing leads and the circuit under test and remove testing leads away from the input terminals of the Meter.

B.Measuring Insulation Resistance

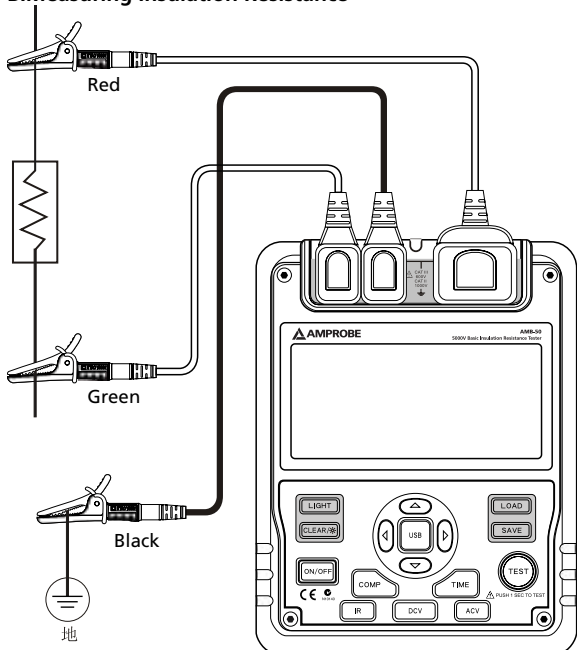

⚠ OPERATING CAUTION!

- When performing insulation resistance tests, remove all power from the circuit to be measured and discharge all the power.
- Operating the Meter must be very careful as it outputs dangerous voltage during measurement. Must make sure the tested object is firmly clipped, hands are away from the clips, then press TEST button to put high voltage.
- Do not short circuit the testing leads during high voltages output or test insulation resistance after high voltages output. This kind of incorrect operating may cause sparking and fire, which damages the Meter and harms to you.
- Do not measure over 10 seconds when:
500V measure resistance lower than $2M\Omega$
1000V measure resistance lower than $5M\Omega$
2500V measure resistance lower than $10M\Omega$
5000V measure resistance lower than $20M\Omega$

To measure insulation resistance, set up the Meter as Figure 5 and do the following:

1. Press IR button to select insulation resistance measurement.
2. When there is no testing voltage output, press ▲ and ▼ button to select voltages of 500V, 1000V, 2500V or 5000V.
3. When performing insulation resistance tests, remove all power from the circuit to be measured and discharged all the power.

4. Insert the red test lead into the LINE input terminal and the black test lead into GUARD input terminal.
5. Connect the red and black alligator clip to the circuit to be measured, negative voltage output from LINE terminal.
6. Choose below insulation resistance measurement mode.

a) Continuous Measurement

- Press TIME button to select continuous measurement mode, there is no timer icon on the LCD.
- Press ◀ and ▶ hold TEST button for 1 second to carry out continuous measurement. Output insulation resistance testing voltage, TEST button light up, Δ blinks on every 0.5 seconds.
- Press TEST button to close the insulation resistance measurement voltage when measurement is completed. TEST button lights off, Δ disappears. The LCD shows the current insulation resistance measurement value.

b) Timed Measurement

- Press TIME button to select timed measurement mode, the LCD displays TIME 1 and ⌚ symbols.
- Press ◀ and ▶ buttons to set the time (00:10~15:00). Within 1 minute, the time increment or decrement by every 5 seconds. Afterward, the time increment or decrement by every 30 seconds.
- Then press and hold TEST button for 2 second to carry out timed measurement. TIME 1 and are displayed and blinked on the LCD on every 0.5 seconds.
- When the set time is reached, the insulation resistance measurement voltage will be closed and the measurement will be automatically stopped. The LCD displays the insulation resistance reading.

c) Polarization Index (PI) Measurement

- Press TIME button to select timed measurement mode, the LCD displays TIME 1 and ⌚ symbols.
- Press ◀ and ▶ buttons to set the time (00:10~15:00). Within 1 minute, the time increment or decrement by every 5 seconds. Afterward, the time increment or decrement by every 30 seconds.
- Press TIME button again. TIME 2, PI and ⌚ symbols appear on the LCD.
- Press ◀ and ▶ buttons to set the time (00:15~15:30). Within 1 minute, the time increment or decrement by every 10 seconds. Afterward, the time increment or decrement by every 30 seconds.
- Then press and hold TEST button for 2 seconds to carry out timed measurement.
- TIME 1 and Δ are displayed and blinked on the LCD on every 0.5 seconds before TIME 1 set time is reached.
- TIME 2 and Δ are displayed and blinked on the LCD on every 0.5 seconds before TIME 2 set time is reached.
- When the two set time are reached, the insulation resistance measurement voltage will be closed and he measurement will be automatically stopped. The LCD displays the polarization index reading.
- Press ◀ , ▶ to set through the polarization index, TIME 2 insulation resistance reading and TIME 2 insulation resistance reading

Information

PI = 3 minutes ~ 10 minutes reading / 30 seconds ~ 1minute reading

PI	4 or more	4~2	2.0~1.0	1.0 or less
Standard	The best	Good	Warning	Bad

d) Compare Function

- Press COMP button to select compare feature. COMP symbol displays on the LCD..
- Press and buttons to set the compare value
- Below is the list in sequence of the compare value: 10M Ω , 20M Ω , 30M Ω , 40M Ω , 50M Ω , 60M Ω , 70M Ω , 80M Ω , 90M Ω , 100M Ω , 200M Ω , 300M Ω , 400M Ω , 500M Ω , 600M Ω , 700M Ω , 800M Ω , 900M Ω , 1G Ω , 2G Ω , 3G Ω , 4G Ω , 5G Ω , 6G Ω , 7G Ω , 8G Ω , 9G Ω , 10G Ω , 20G Ω , 330G Ω , 40G Ω , 50G Ω , 60G Ω , 70G Ω , 80G Ω , 90G Ω , 100G Ω , 200G Ω , 300G Ω , 400G Ω , 500G Ω , 600G Ω , 700G Ω , 800G Ω , 900G Ω
- Press and hold TEST button for 2 seconds to carry out the measurement.
- The NG symbol will display if the insulation resistance value is smaller than resistance value. Otherwise GOOD symbol will be displayed.

The Use of Power Adaptor

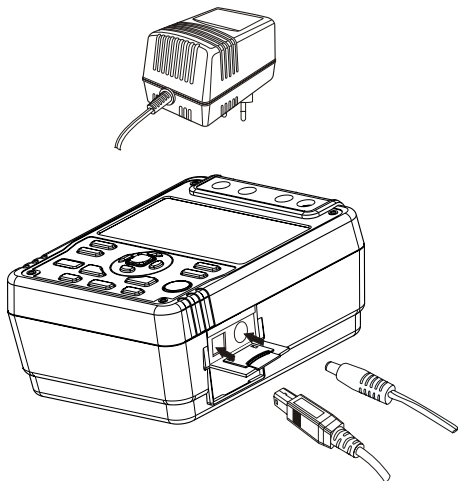

1. Open the side safety shutter, then you will see there is a power adaptor input terminal.
2. Make sure the Meter is power off and insert the UT513 power adaptor to the input terminal.
3. It is highly recommended to take out all the batteries when you are using the power adaptor.
4. Make sure the Meter is power off when you disconnect the UT513 power adaptor from the Meter.

USB Interface

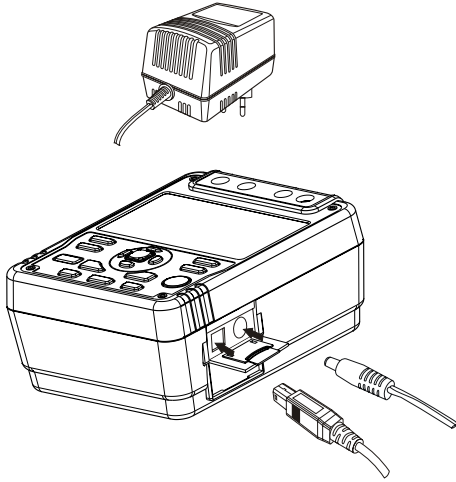





1. Install the included software, the installation guide can be seen from the CD.
2. Open the side safety shutter, then you will see there is a USB port.
3. Insert the included USB cable to the Meter's USB port and the other end to the computer.

Battery Saver (Sleep Mode)

The Meter enters the Sleep Mode and blanks the display if there is no button press for 15 minutes. This is done to conserve battery power. The Meter comes out of Sleep Mode when ON/OFF button is pressed and hold for 1 second.

Battery Indication

Battery Indicator	Battery Voltage
	10V or less. The battery is empty, don't use the Meter as it cannot guarantee accuracy.
	10V~10.5V. The battery is nearly empty, replacing battery is necessary. At this status, the Meter can still do 500V and 1000V output measurement, accuracy will not be affected.
	10.6V~11.5V :Good
	11.6V or more :Full

SPECIFICATIONS

Safety and Compliances

Certification	CE
Compliances	IEC 61010 CAT.III 600V overvoltage and double insulation standard

Physical Specifications

Display (LCD)	Digital: 1999 counts Analog bar graph.
Operating Temperature	0°C~40°C (32°F ~104°F)
Storage Temperature	-20°C ~60°C (-4 °F~152°F)
Relative Humidity	≤ 85% @ -10°C ~40°C below; ≤ 90% @ 0°C ~40°C :
Battery Type	8pcs X 1.5V (LR14) batteries or power adaptor (input voltage 230V, 50/60Hz, 75mA, input DC14V, 1.0A). Power adaptor is not included
Dimensions (H x W x L)	202 x 155 x 94 mm
Weight	Approx. 2kg (4.4 Lbs) (including battery)

General Specifications

Range	Auto
Overloading	Display OL on insulation resistance range
Battery Indicator	Display 
Icon Display	Equips with function and battery indicator icons.
Current Consumption	Maximum: around 1.0A Average: around 20mA

Feature Summary

Display Backlight	Bright backlight for clear readings in poorly lighted areas.
Computer connection	Via USB interface.
Data Logging and Recall	18
Autorange	The Meter automatically selects best range
Warning	⚠ and red light will on.
Voltage	Auto release voltage
COMP Measurement	Use the Compare function to set a pass/fail compare level for the insulation measurements.
PI Measurement	Polarization Index is the ratio of insulation resistance. You can pre-set two point of times and automatically carry out the measurement.
TIME	To carry out measurement by setting a specified time within 15 minutes.

Detailed Accuracy Specifications

Accuracy: \pm ([a% of reading] + [number of least significant digits]), guarantee for 1 year.

Operating temperature: 18°C ~28°C

Relative humidity: 45~75%RH

A. Voltage Measurement

	DC Voltage	AC Voltage
Measurement Range	$\pm 30 \sim \pm 600V$	30V~600V (50/60Hz)
Resolution	1V	
Accuracy	$\pm(2\%+5)$ Among them 30~100V(50/60Hz) $\pm(2\%+8)$	

B. Insulation Resistance Measurement

Output Voltage	500V	1000V	2500V	5000V
Display Range	0.5M Ω ~20G Ω	2M Ω ~40G Ω	5M Ω ~100G Ω	100M Ω ~1000G Ω
Open Circuit Voltage	DC 500V 0%~+ 20%	DC1000V 0%~+ 20%	DC 2500V 0%~+ 20%	DC5000V 0%~+ 20%
Test Current	1mA~1.2mA @ 500k Ω	1mA~1.2mA @ 1M Ω	1mA~1.2mA @ 2.5M Ω	1mA~1.2mA @ 5M Ω
Accuracy	0.50M ~99.9M : $\pm(3\%+5)$ 100M ~9.99G : $\pm(5\%+5)$ 10.0G ~20.0G : $\pm(10\%+5)$	2.0M ~99.9M : $\pm(3\%+5)$ 100M ~9.99G : $\pm(5\%+5)$ 10.0G ~40.0G : $\pm(10\%+5)$	5.0M ~99.9M : $\pm(3\%+5)$ 100M ~9.99G : $\pm(5\%+5)$ 10.0G ~100G : $\pm(10\%+5)$	10.0M ~29.9M : (For reference only) 30.0M ~99.9M : $\pm(3\%+5)$ 100M ~9.99G : $\pm(5\%+5)$ 10.0G ~99.9G : $\pm(10\%+5)$ Above 100G : [$\pm(20\%+5)$ Humidity:Below 50%]
Short Circuit	Less than 2.0mA			

⚠ OPERATING CAUTION

At any output voltage, when the tested resistance is less than 10M , the testing time cannot exceed 10 seconds continuously.

MAINTENANCE AND REPAIR

If there appears to be a malfunction during the operation of the meter, the following steps should be performed in order to isolate the cause of the problem.

1. Check the battery. Replace the battery immediately when the symbol " " appears on the LCD.
2. Review the operating instructions for possible mistakes in operating procedure.

Except for the replacement of the battery, repair of the meter should be performed only by a Factory Authorized Service Center or by other qualified instrument service personnel. The front panel and case can be cleaned with a mild solution of detergent and water. Apply sparingly with a soft cloth and allow to dry completely before using. Do not use aromatic hydrocarbons, Gasoline or chlorinated solvents for cleaning.

- Periodically wipe the case with a damp cloth and mild detergent. Do not use abrasives or solvents.
- To clean the terminals with cotton bar with detergent, as dirt or moisture in the terminals can affect readings.

- Turn the Meter to OFF when it is not in use.
- Take out the battery when it is not using for a long time.
- Do not use or store the Meter in a place of humidity, high temperature, explosive, inflammable and strong magnetic field.
- If the Meter is wet, dry it before use.

⚠ WARNING!

- ***Do not attempt to repair or service your Meter unless you are qualified to do***
- ***Bring this line up. This is one sentence and have the relevant calibration, performance test, and service information.***

Replacing the Battery

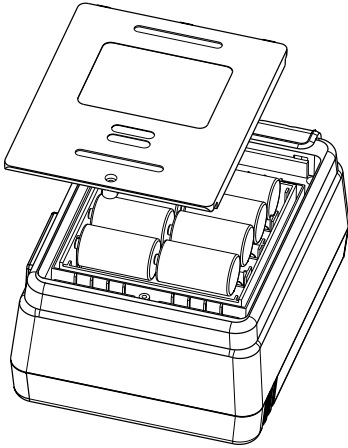

⚠ WARNING!

To Avoid Electric shock, remove all the test leads from the Meter replacing the batteries.

⚠ OPERATING CAUTION!

- ***Don't mix old and new batteries.***
- ***Make sure the polarity is correct when installing batteries.***
- ***Do not use the Meter if the battery indicator () shows a battery empty condition***
- ***Do not carry out measuring with the battery compartment is open.***

Follow the shown picture and proceed as follows to replace the battery:

- Turn the Meter to OFF and remove all connections from the terminals.
- Remove the screw from the battery compartment, and separate the battery compartment from the case bottom.
- Replace with 6pcs of new 1.5V (LR14) batteries.
- Rejoin the case bottom and battery compartment, and reinstall the screw.

Visit www.Amprobe.com for

- Catalog
- Application notes
- Product specifications
- User manuals



Please Recycle