



# TAOGLAS®



# Datasheet

## FXUB63.54.0150C

Patent Pending

### Description:

LTE Wide Band Flex Antenna 698MHz - 3000 MHz

### Features:

- Patent Pending
- Ground Plane Independent
- 698-3000 MHz
- >45% Efficiency on All covered bands
- 5dBi Peak Gain
- Connector: I-PEX MHF® 4L (HSC Compatible)
- Cable: 150mm 1.37 Coax
- Dimensions: 96\*21\*0.2 mm
- RoHS & Reach Compliant

1.	Introduction	3
2.	Specifications	4
3.	Antenna Characteristics	6
4.	3D Radiation Patterns	9
5.	Mechanical Drawing	21
6.	Packaging	22
<hr/>		
	Changelog	23

Taoglas makes no warranties based on the accuracy or completeness of the contents of this document and reserves the right to make changes to specifications and product descriptions at any time without notice. Taoglas reserves all rights to this document and the information contained herein.

Reproduction, use or disclosure to third parties without express permission is strictly prohibited.



# 1. Introduction

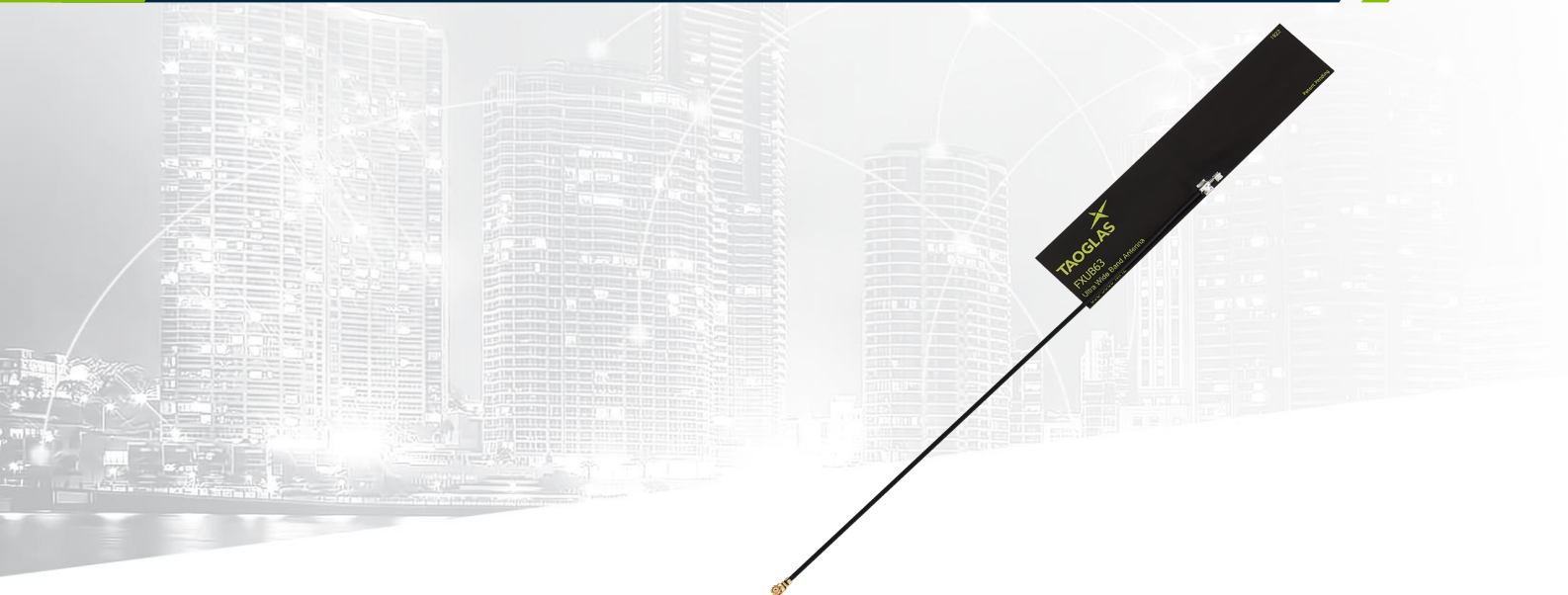

The patent pending FXUB63 flexible wideband antenna has been designed to cover all working frequencies in the 698-3000MHz spectrum, covering all Cellular, 2.4GHz Wi-Fi, ISM and AGPS. The antenna is delivered with a flexible body with excellent efficiencies on all bands, ground independent, with cable and connector for easy installation.

The FXUB63 flexible polymer antenna, at 96\*21\*0.2mm, is ultra thin and wideband with high efficiencies across the bands. It is assembled by a simple “peel and stick” process, attaching securely to non-metal surfaces via 3M adhesive. It enables designers to use only one antenna that covers all common LTE frequencies.

The FXUB63 antenna is a durable flexible polymer antenna that has a peak gain of 5dBi, an efficiency of more than 45% across the bands and is designed to be mounted directly onto a plastic or glass cover. It is an ideal choice for any device maker that needs to keep manufacturing costs down over the lifetime of a product. It is ground plane independent and delivered with a cable and connector for easy connecting to the wireless module or customer PCB.

The FXUB63 uses a future proof I-PEX MHF® 4L connector for 5G applications to match the many module providers new 5G modules who utilize this smaller receptacle.

Cables and Connectors are customizable. Like all such antennas, care should be taken to mount the antenna at least 10mm from metal components or surfaces, and ideally 20mm for best radiation efficiency.

## 2. Specifications

Electrical						
Frequency (MHz)	698-960	1575.42	1710 -1990	1755-2170	2400 -2500	2500-2690
Efficiency (%)						
With Ground Plane (3mm ABS)	52	67	75	72	71	62
Average Gain (dB)						
With Ground Plane (3mm ABS)	-2.9	-1.7	-1.2	-1.4	-1.5	-2.1
Peak Gain (dBi)						
With Ground Plane (3mm ABS)	4.5	2.33	4.6	4.7	4.4	4.0
Max VSWR						
With Ground Plane (3mm ABS)	5.2	2.0	1.9	2.0	1.8	1.8
Max Return Loss (dB)						
With Ground Plane (3mm ABS)	-3.4	-9.7	-10.5	-9.8	-10.7	-10.7
Impedance	50Ω					
Polarization	Linear					
Radiation Pattern	Omni					
Input Power	5W Max					
Mechanical						
Dimensions (mm)	96*21*0.2 mm					
Material	Flexible Polymer					
Connector	I-PEX MHF® 4L (HSC Compatible)					
Cable Length	150 mm					
Cable	1.37 mm mini coax					
Environmental						
Operation Temperature	-40°C to 85°C					
Storage Temperature	-40°C to 85°C					
Relative Humidity	40% to 95%					

5G/4G Bands			
Band Number	5GNR / FR1 / LTE / LTE-Advanced / WCDMA / HSPA / HSPA+ / TD-SCDMA		
	Uplink	Downlink	Covered
1	UL: 1920 to 1980	DL: 2110 to 2170	✓
2	UL: 1850 to 1910	DL: 1930 to 1990	✓
3	UL: 1710 to 1785	DL: 1805 to 1880	✓
4	UL: 1710 to 1755	DL: 2110 to 2155	✓
5	UL: 824 to 849	DL: 869 to 894	✓
7	UL: 2500 to 2570	DL: 2620 to 2690	✓
8	UL: 880 to 915	DL: 925 to 960	✓
9	UL: 1749.9 to 1784.9	DL: 1844.9 to 1879.9	✓
11	UL: 1427.9 to 1447.9	DL: 1475.9 to 1495.9	✓
12	UL: 699 to 716	DL: 729 to 746	✓
13	UL: 777 to 787	DL: 746 to 756	✓
14	UL: 788 to 798	DL: 758 to 768	✓
17	UL: 704 to 716	DL: 734 to 746	✓
18	UL: 815 to 830	DL: 860 to 875	✓
19	UL: 830 to 845	DL: 875 to 890	✓
20	UL: 832 to 862	DL: 791 to 821	✓
21	UL: 1447.9 to 1462.9	DL: 1495.9 to 1510.9	✓
22	UL: 3410 to 3490	DL: 3510 to 3590	✗
23	UL: 2000 to 2020	DL: 2180 to 2200	✓
24	UL: 1625.5 to 1660.5	DL: 1525 to 1559	✓
25	UL: 1850 to 1915	DL: 1930 to 1995	✓
26	UL: 814 to 849	DL: 859 to 894	✓
27	UL: 807 to 824	DL: 852 to 869	✓
28	UL: 703 to 748	DL: 758 to 803	✓
29	UL: -	DL: 717 to 728	✓
30	UL: 2305 to 2315	DL: 2350 to 2360	✓
31	UL: 452.5 to 457.5	DL: 462.5 to 467.5	✗
32	UL: -	DL: 1452 - 1496	✓
35		1850 to 1910	✓
38		2570 to 2620	✓
39		1880 to 1920	✓
40		2300 to 2400	✓
41		2496 to 2690	✓
42		3400 to 3600	✗
43		3600 to 3800	✗
48		3550 to 3700	✗
66	UL: 1710-1780	DL: 2110-2200	✓
71		617 to 698	✓
74/75/76		1427 to 1518	✓
78		3300 to 3800	✗
79		4400 to 5000	✗
85	698-716	728-746	✓

### 3. Antenna Characteristics

#### 3.1 Return Loss

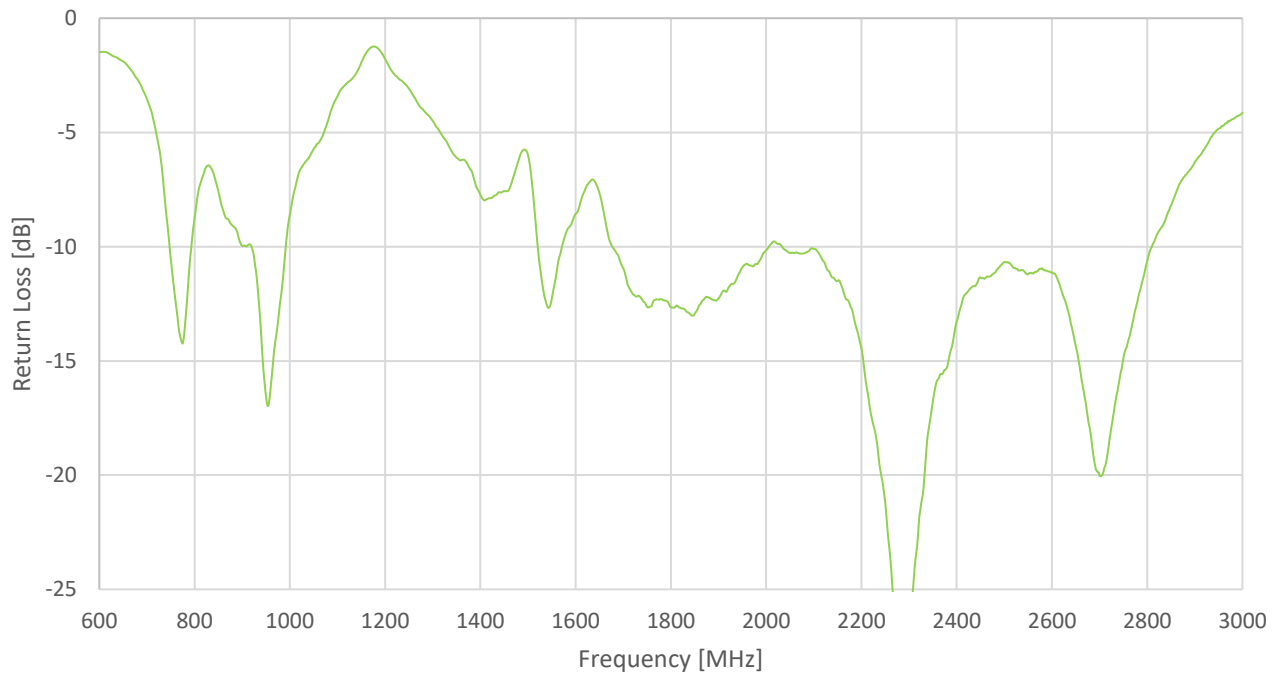

#### 3.2 VSWR

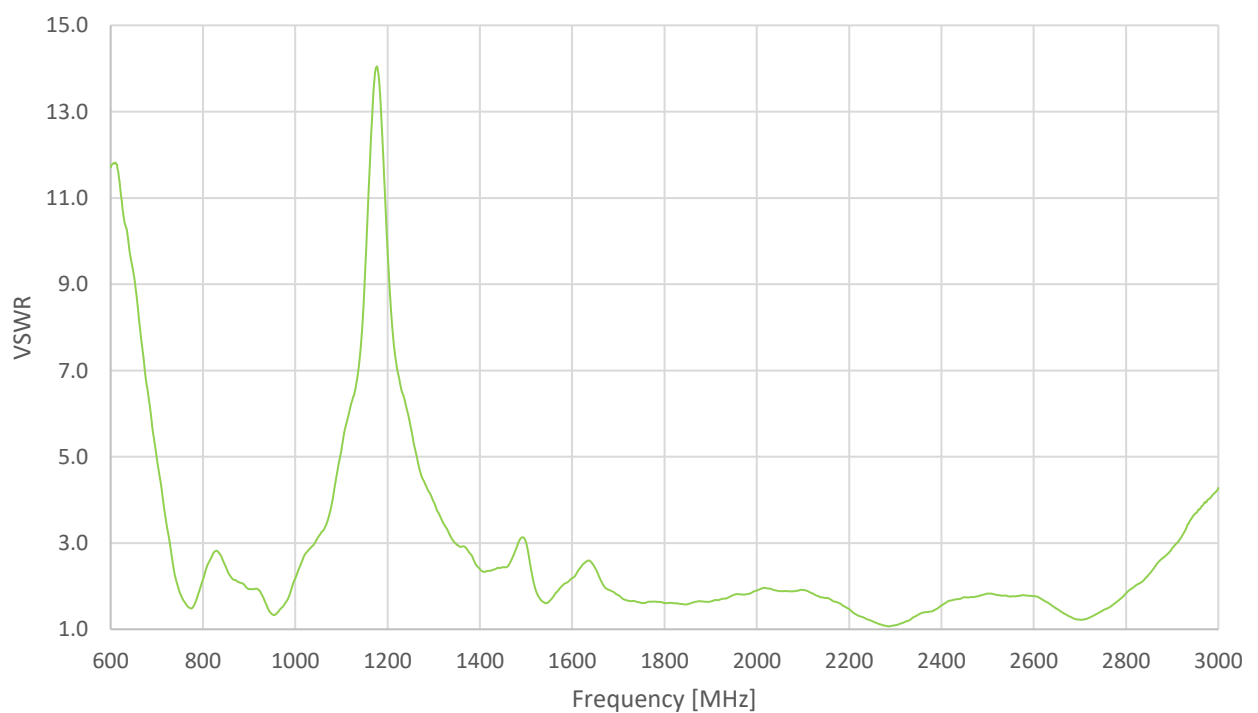

### 3.3 Peak Gain

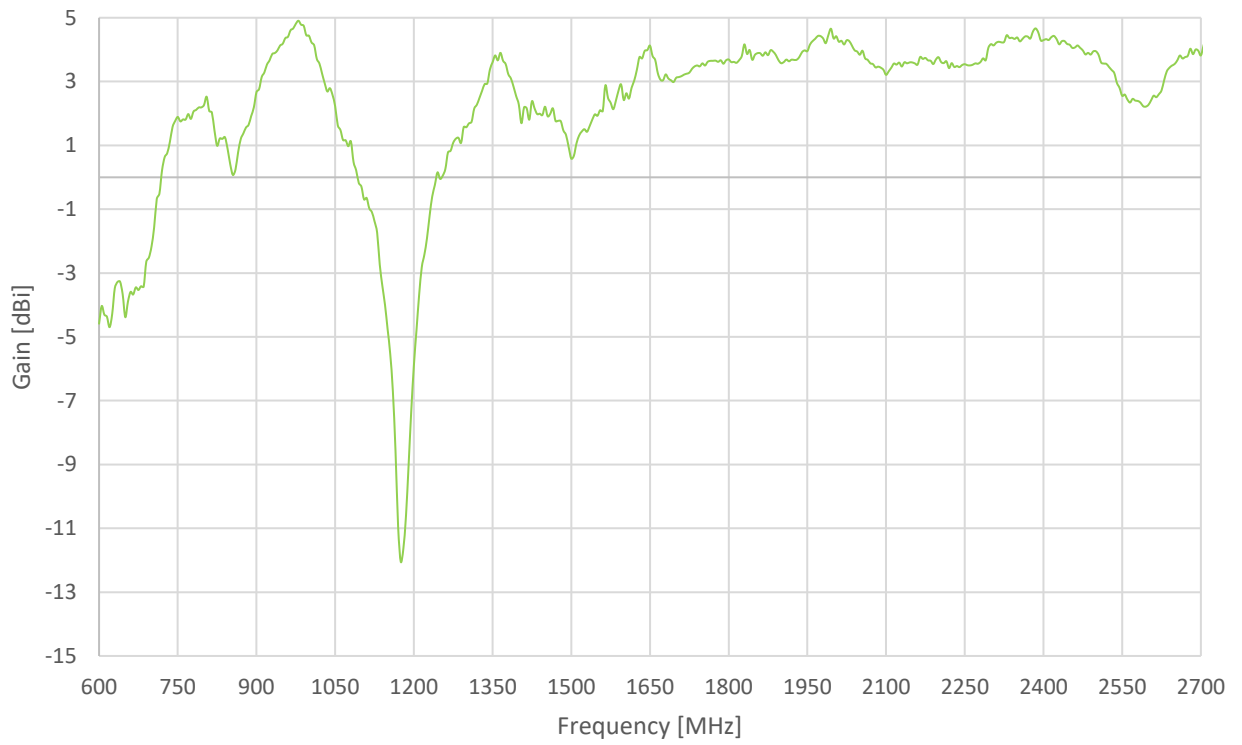

### 3.4 Average Gain

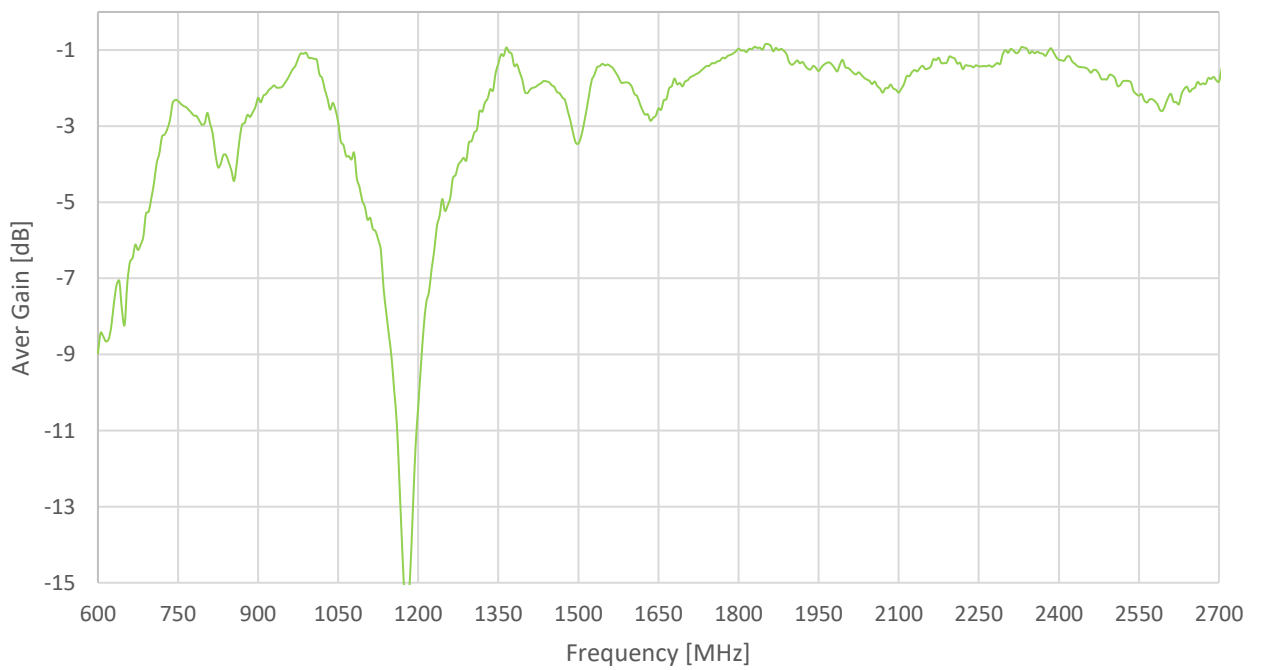

3.5 Efficiency

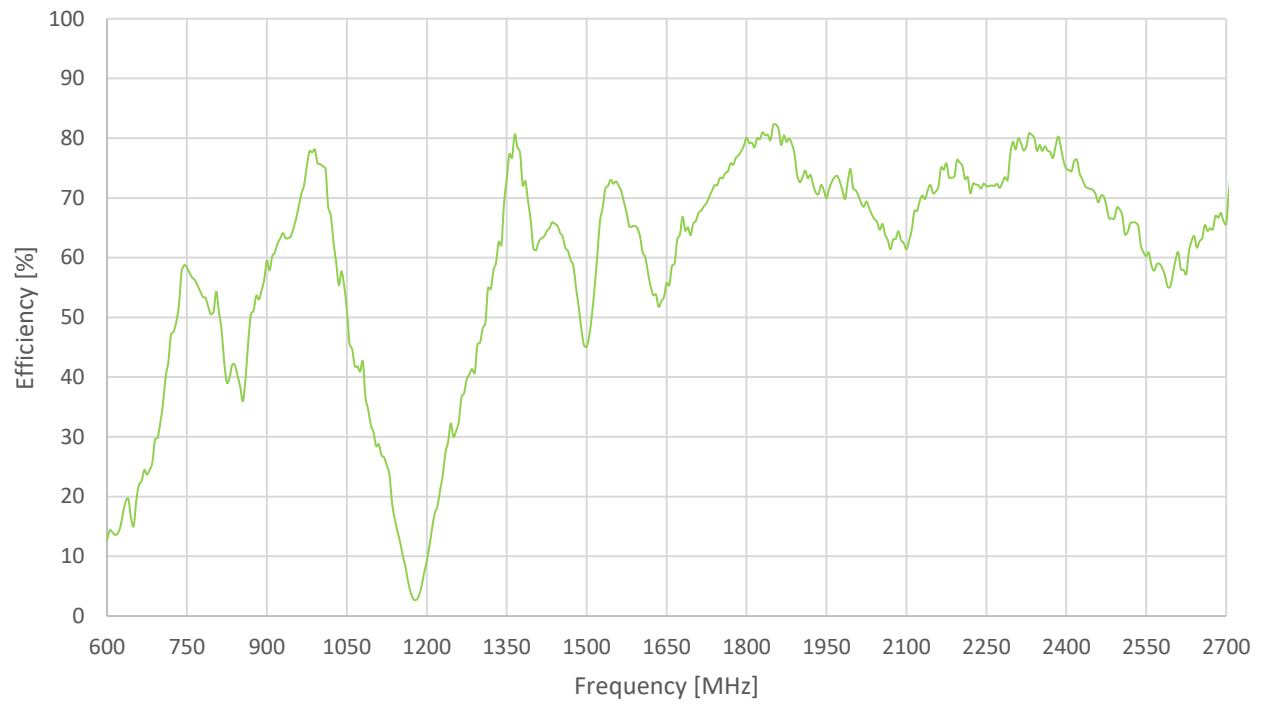



## 4. Radiation Patterns

### 4.1 Test Setup

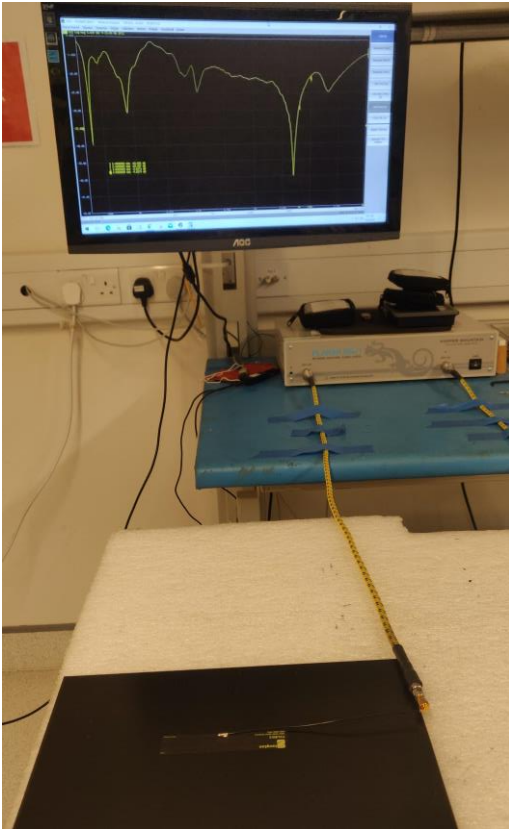

VNA Set-Up



Chamber Set-Up

750MHz

Azimuth = 0.0  
 Elevation = 0.0  
 Roll = -35.0

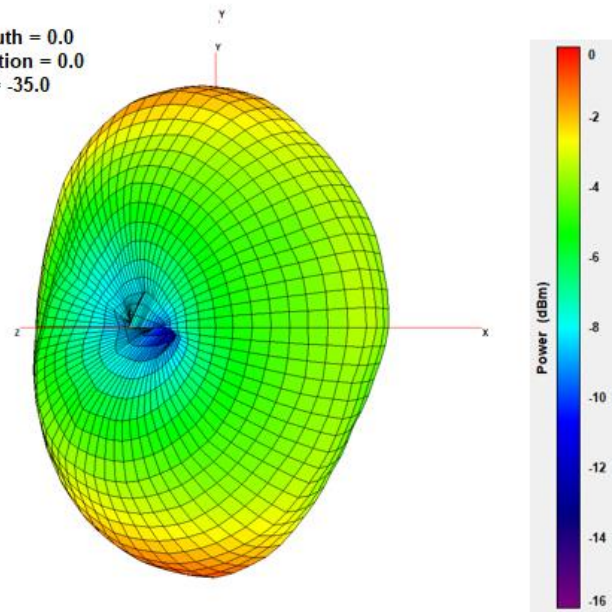

XY Plane

XZ Plane

YZ Plane

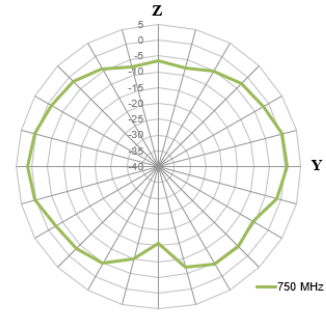
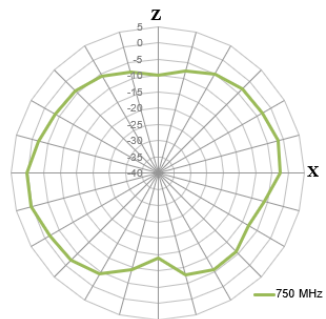
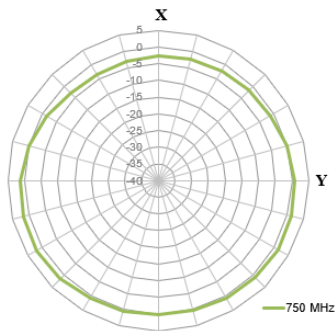

850MHz

Azimuth = 0.0  
Elevation = 0.0  
Roll = -35.0

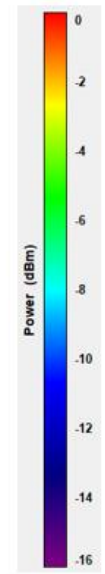
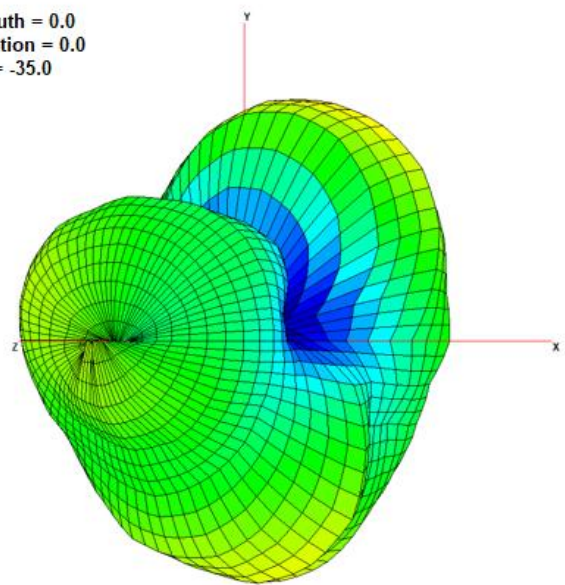

XY Plane      XZ Plane      YZ Plane

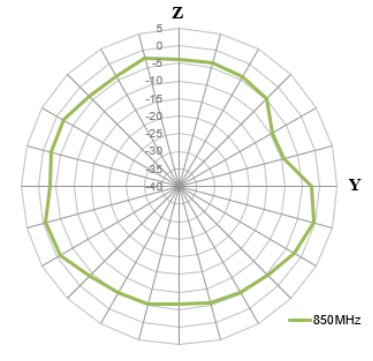
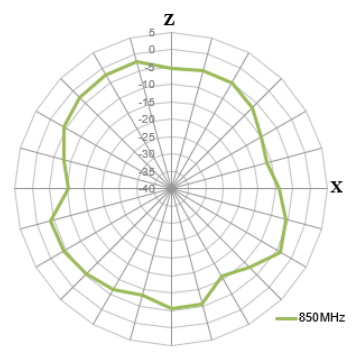
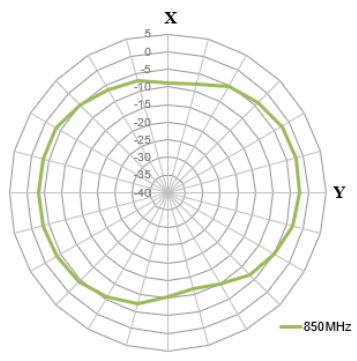

925MHz

Azimuth = 0.0  
Elevation = 0.0  
Roll = -35.0

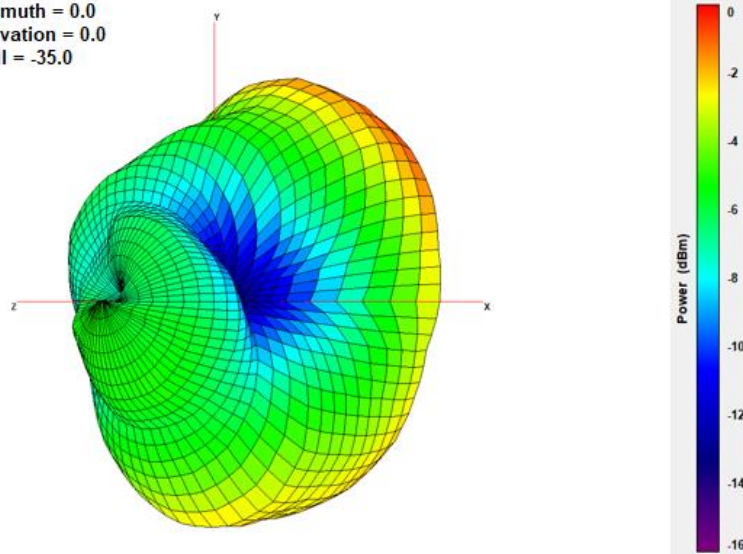

XY Plane

XZ Plane

YZ Plane

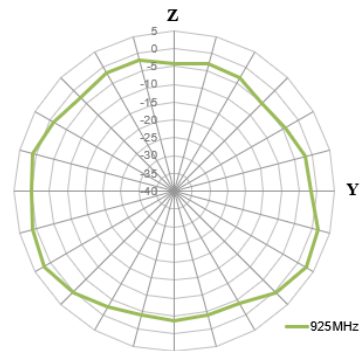
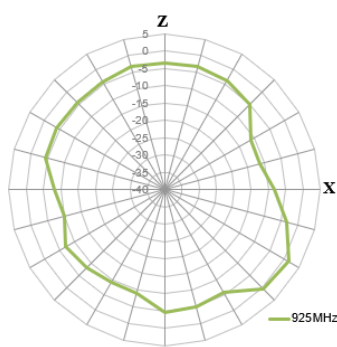
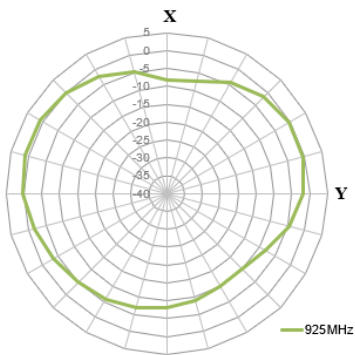

1400MHz

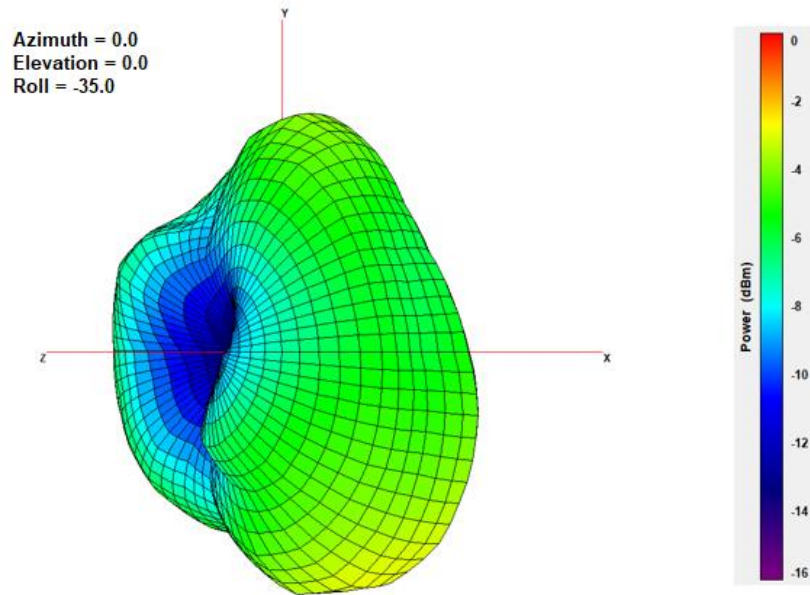

XY Plane

XZ Plane

YZ Plane

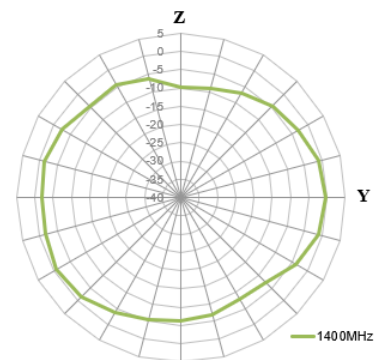
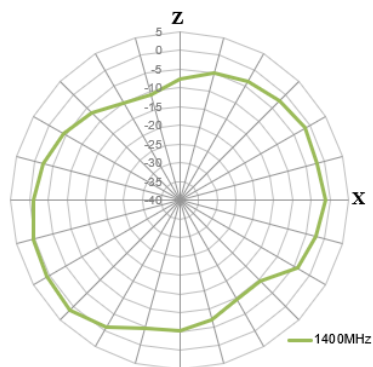
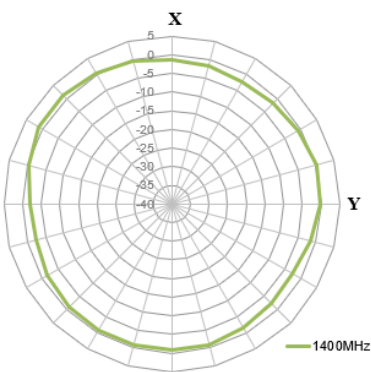

1575MHz

Azimuth = 0.0  
Elevation = 0.0  
Roll = -35.0

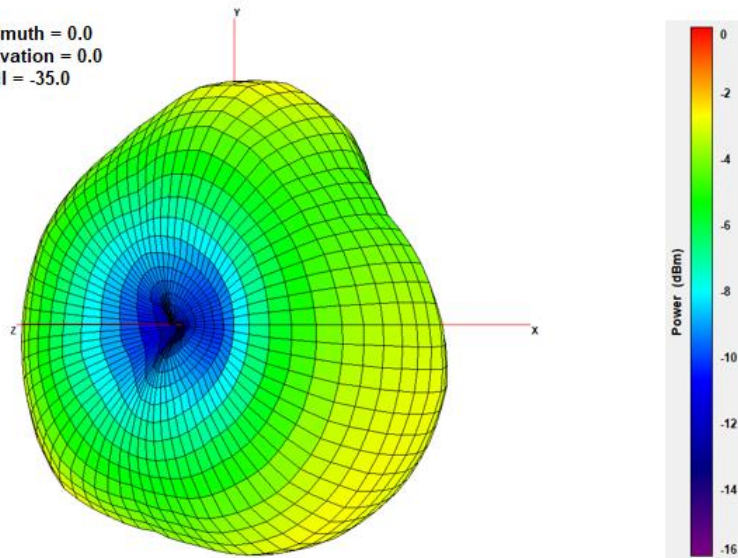

XY Plane

XZ Plane

YZ Plane

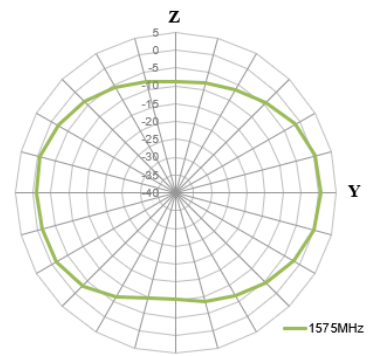
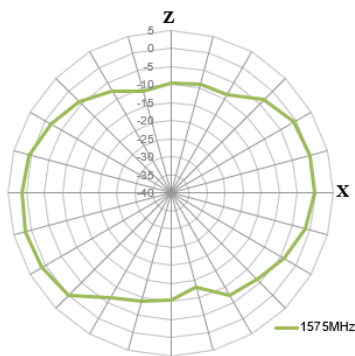
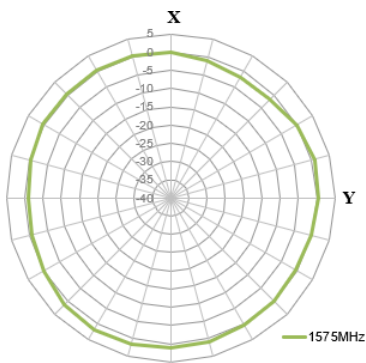

1750MHz

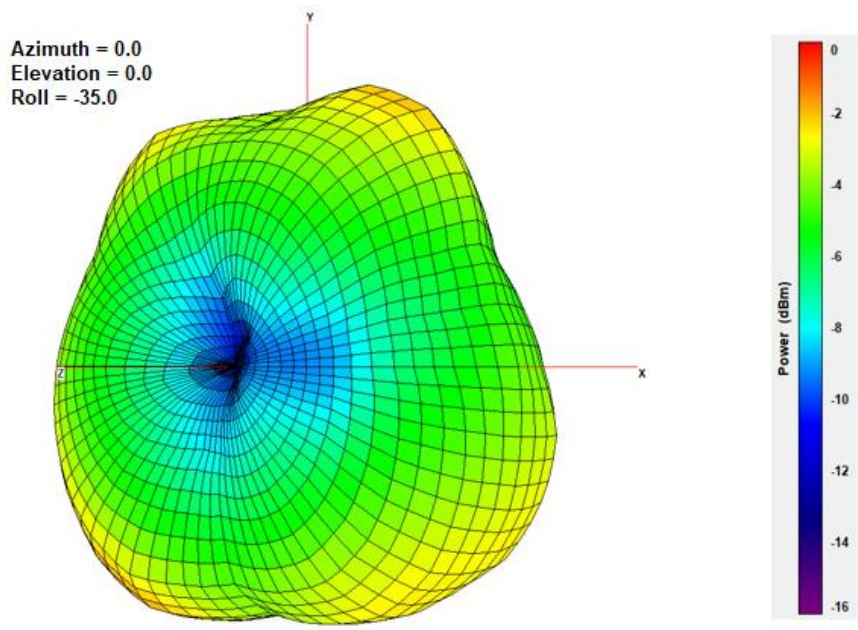

XY Plane

XZ Plane

YZ Plane

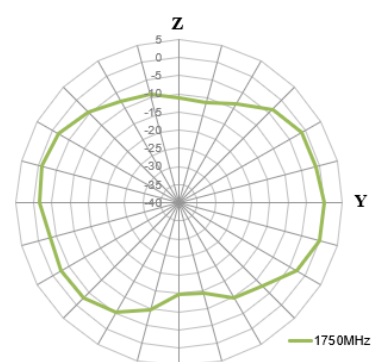
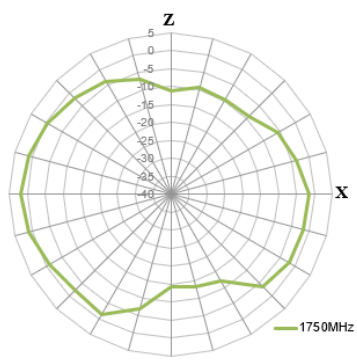
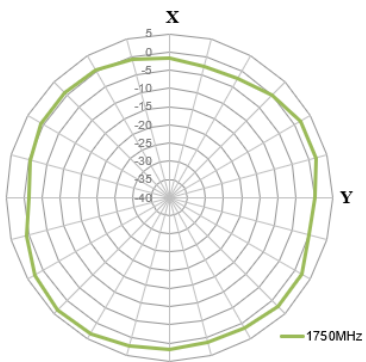

1850MHz

Azimuth = 0.0  
Elevation = 0.0  
Roll = -35.0

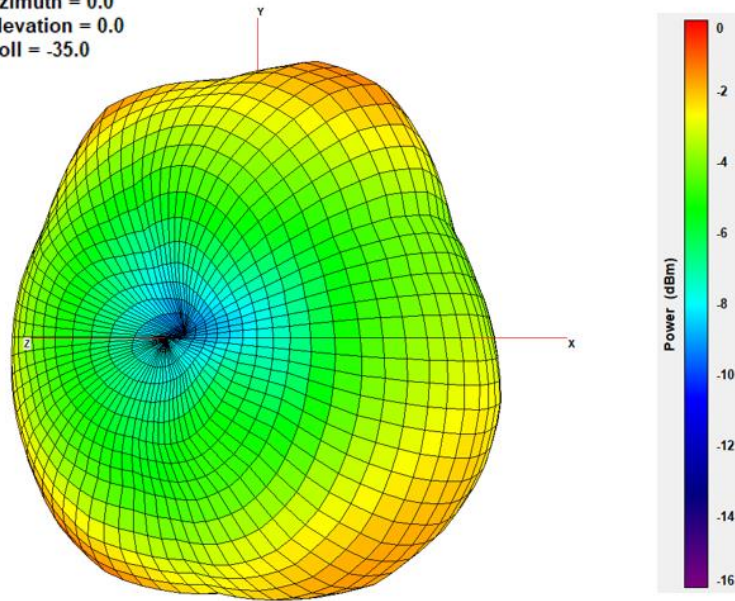

XY Plane

XZ Plane

YZ Plane

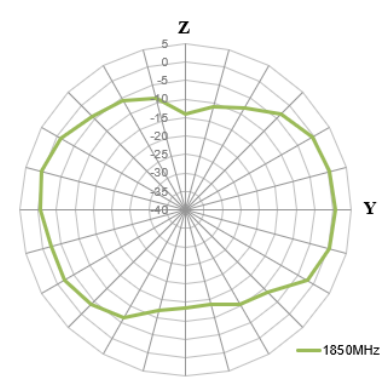
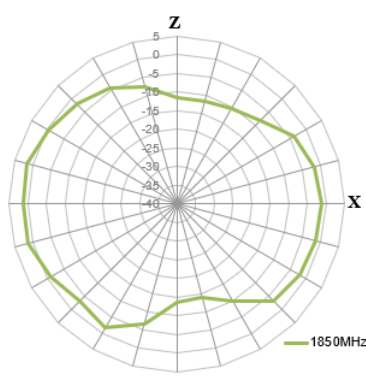
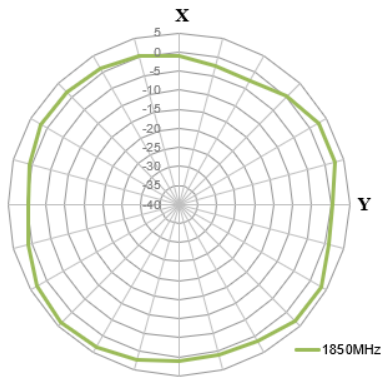



1950MHz

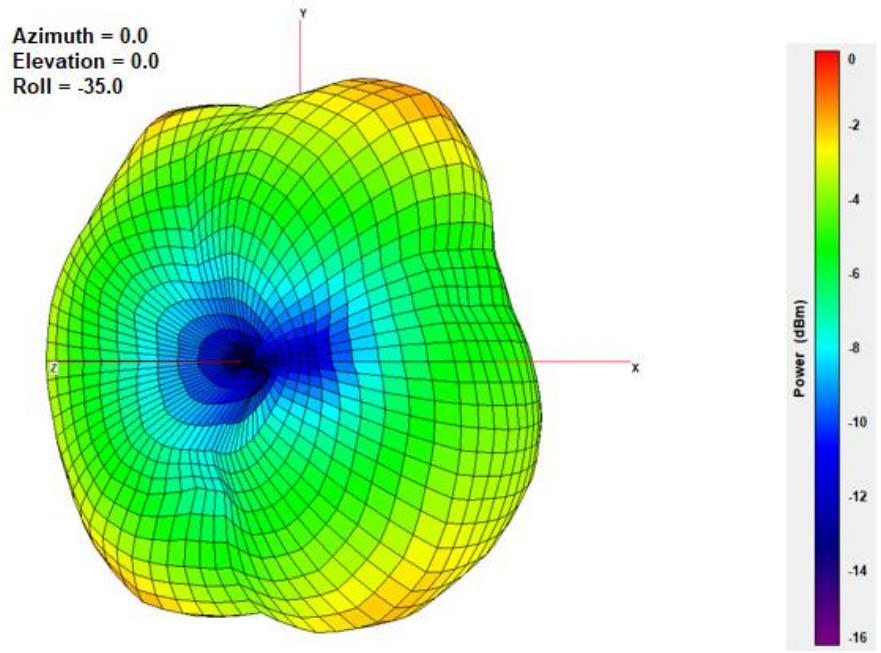

XY Plane

XZ Plane

YZ Plane

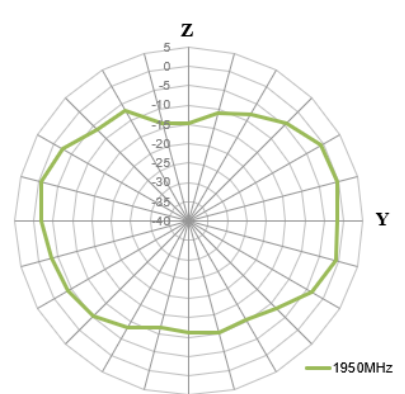
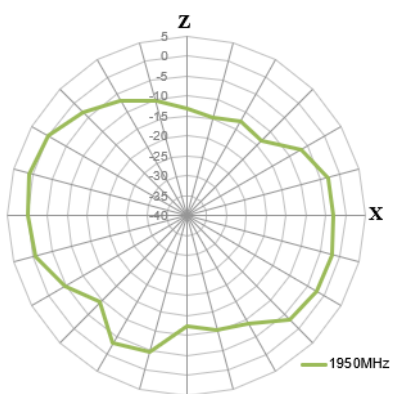
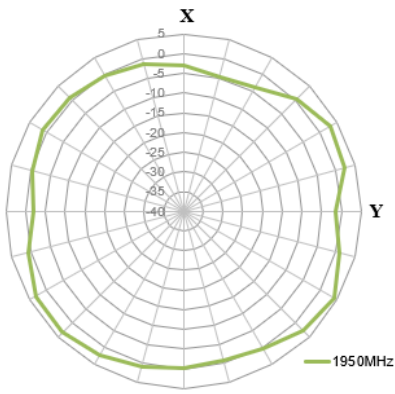

2100MHz

Azimuth = 0.0  
Elevation = 0.0  
Roll = -35.0

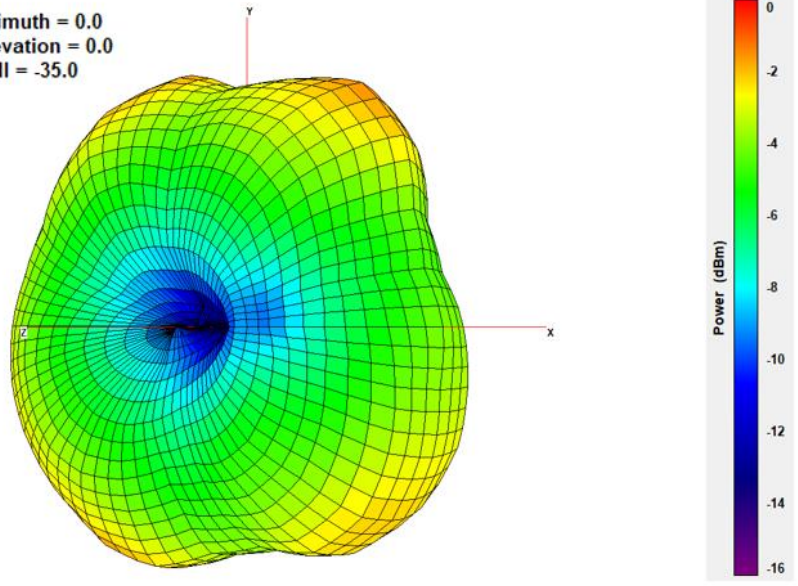

XY Plane

XZ Plane

YZ Plane

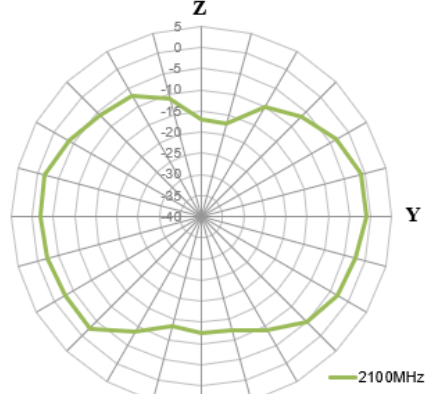
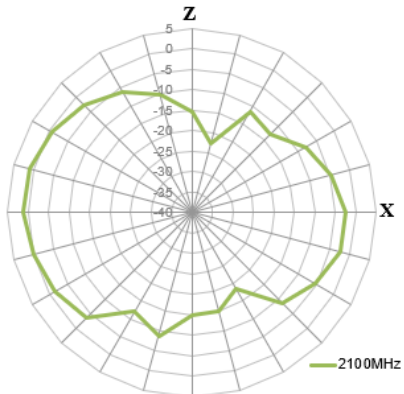
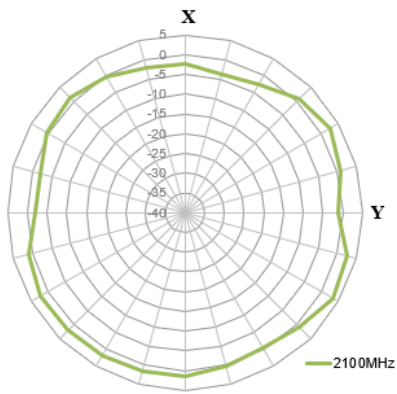

2450MHz

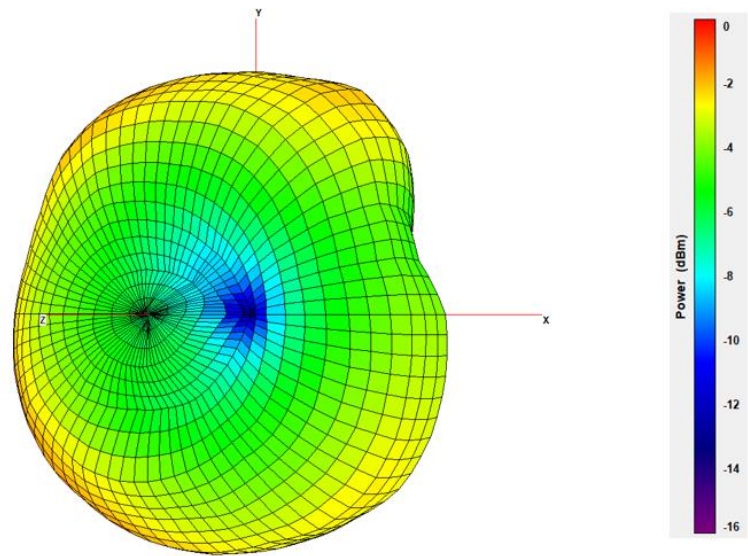

XY Plane

XZ Plane

YZ Plane

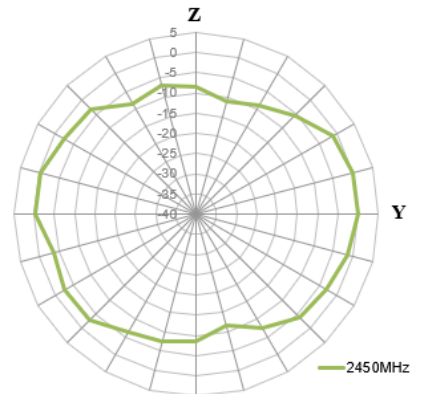
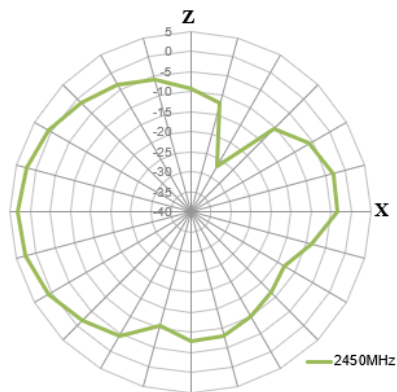
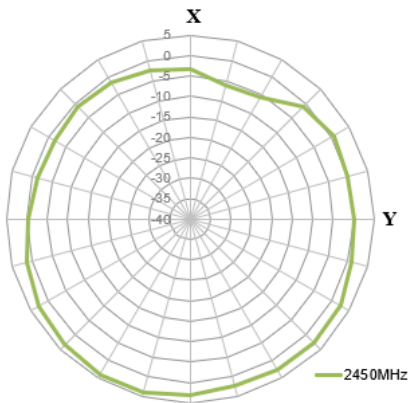

2600MHz

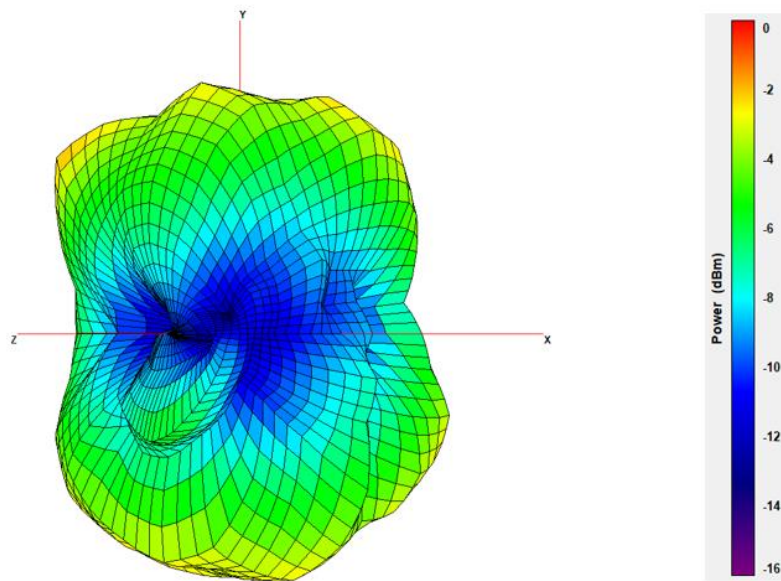

XY Plane

XZ Plane

YZ Plane

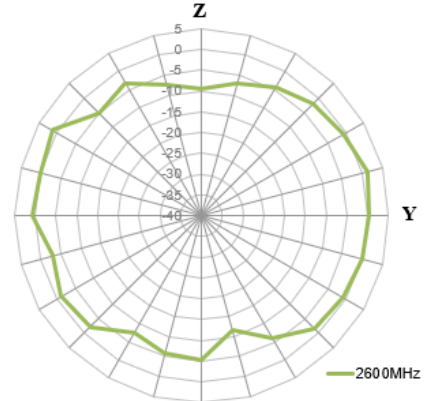
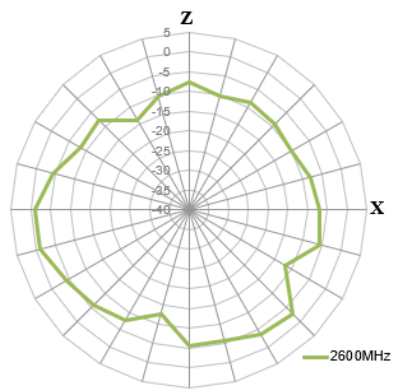
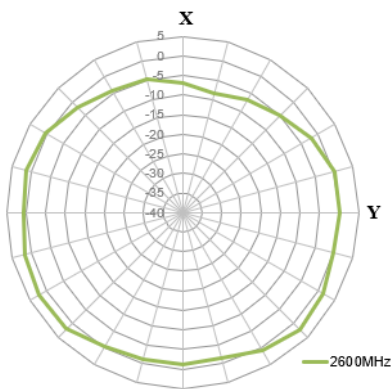

# 5. Drawing

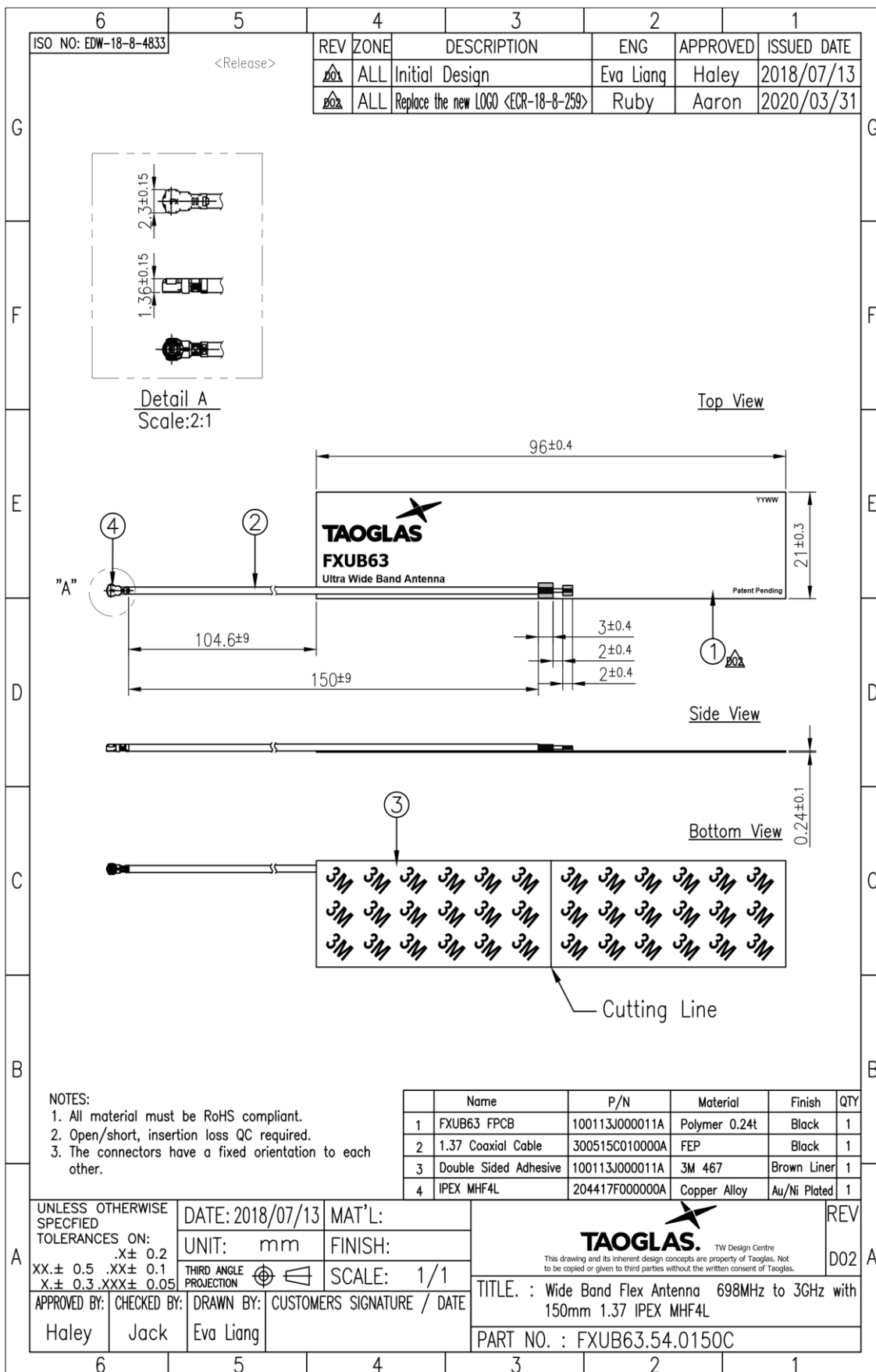

## 6. Packaging

100pcs FXUB63.54.0150C per PE Bag  
 Dimensions - 300\*100  
 Weight - 150g

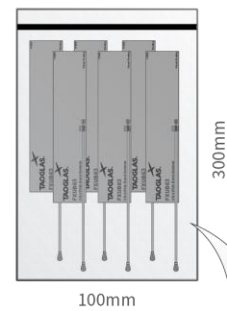

1000pcs FXUB63.54.0150C per Large PE Bag  
 Dimensions - 450\*280mm  
 Weight - 1.5Kg

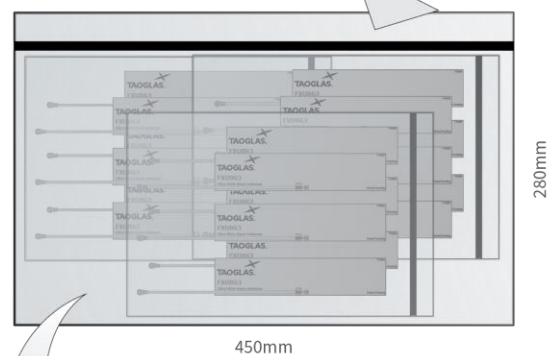

5000pcs FXUB63.54.0150C per carton  
 Dimensions - 320\*250\*230mm  
 Weight - 6Kg

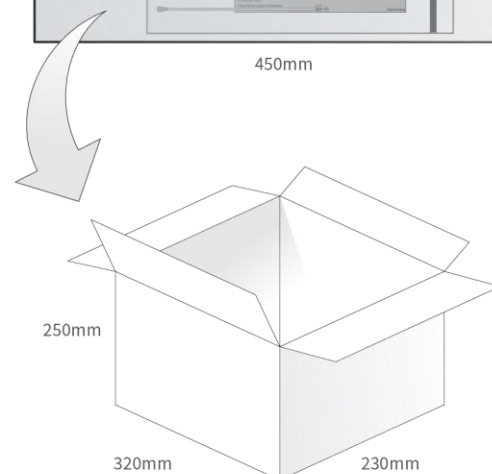

Pallet Dimensions:  
 1100\*1100\*1300mm  
 65 Cartons Per Pallet  
 13 Cartons Per Layer  
 5 Layers

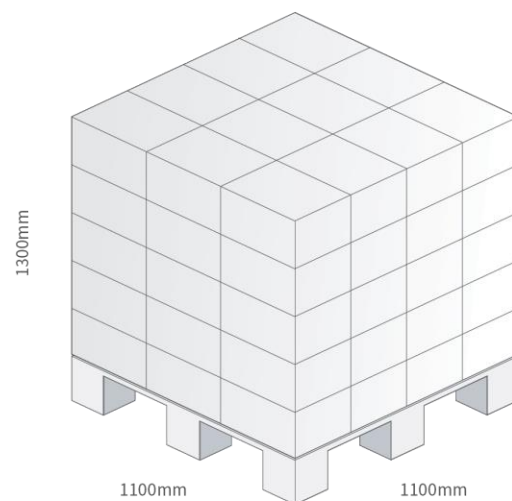

Changelog for the datasheet

**SPE-21-8-015 – FXUB63.54.0150C**

**Revision: A (Original First Release)**

Date:	2021-03-18
Notes:	Release
Author:	Jack Conroy

**Previous Revisions**



**TAOGLAS**®

[www.taoglas.com](http://www.taoglas.com)

