

# GaN Amplifier 50 V, 300 W DC - 2.7 GHz



MAGX-100027-300C0P

Rev. V2

## Features

- Suitable for Linear and Saturated Applications
- Pair of Isolated, Symmetric Amplifiers
- CW and Pulsed Operation: 300 W Output Power
- Internally Pre-Matched
- 260°C Reflow Compatible
- 50 V Operation
- 100% RF Tested
- RoHS\* Compliant

## Description

The MAGX-100027-300C0P is high power GaN on Si HEMT device optimized for DC - 2.7 GHz frequency operation. The device supports both CW and pulsed operation with peak output power levels of 300 W (54.8 dBm) in a plastic package.

The MAGX-100027-300C0P is ideally suited for a multitude of applications including military radio communications, digital cellular infrastructure, RF energy, avionics, test instrumentation and RADAR.

## Typical Performance:

- $V_{DS} = 50\text{ V}$ ,  $I_{DQ} = 100\text{ mA}$ ,  $T_C = 25^\circ\text{C}$ . One side Measured under pulsed load-pull at 2.5 dB Compression, 100  $\mu\text{s}$  pulse width, 1 ms period, 10% duty cycle

Frequency (GHz)	Output Power <sup>1</sup> (dBm)	Gain <sup>2</sup> (dB)	$\eta_D^2$ (%)
0.9	53.5	20.0	71.1
1.4	53.3	17.6	74.8
2.0	53.5	15.0	64.3
2.5	53.5	13.5	64.8
2.7	53.4	13.5	65.3

1. Load impedance tuned for maximum output power.
2. Load impedance tuned for maximum drain efficiency.

## Ordering Information

Part Number	Package
MAGX-100027-300C0P	Bulk quantity
MAGX-100027-300CTP	Tape and Reel
MAGX-1A0027-300C0P	Sample board

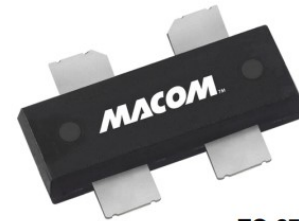

TO-272S-4I

## Functional Schematic

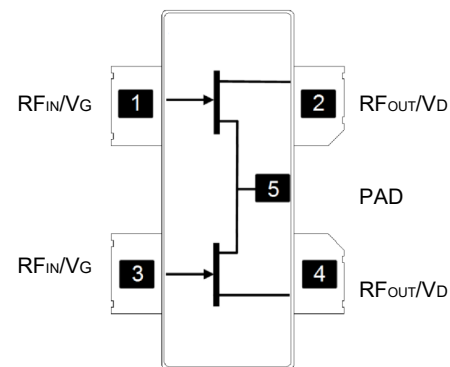

## Pin Configuration

Pin #	Pin Name	Function
1	$RF_{IN} / V_{G1}$	RF Input / Gate
2	$RF_{OUT} / V_{D1}$	RF Output / Drain
3	$RF_{IN} / V_{G2}$	RF Input / Gate
4	$RF_{OUT} / V_{D2}$	RF Output / Drain
5	Pad <sup>3</sup>	Ground / Source

3. The exposed pad centered on the package bottom must be connected to RF, DC and thermal ground.

<sup>1</sup> \* Restrictions on Hazardous Substances, compliant to current RoHS EU directive.

**RF Electrical Characteristics:  $T_C = 25^\circ\text{C}$ ,  $V_{DS} = 50\text{ V}$ ,  $I_{DQ} = 200\text{ mA}$**   
**Note: Performance in MACOM Evaluation Test Fixture, 50  $\Omega$  system**

Parameter	Test Conditions	Symbol	Min.	Typ.	Max.	Units
Small Signal Gain	Pulsed <sup>4</sup> , 2 GHz	$G_{SS}$	-	16.3	-	dB
Power Gain	Pulsed <sup>4</sup> , 2 GHz, 2.5 dB Gain Compression	$G_{SAT}$	-	14.0	-	dBm
Saturated Drain Efficiency	Pulsed <sup>4</sup> , 2 GHz, 2.5 dB Gain Compression	$\eta_{SAT}$	-	57.5	-	%
Saturated Output Power	Pulsed <sup>4</sup> , 2 GHz, 2.5 dB Gain Compression	$P_{SAT}$	-	55.5	-	dBm
Gain Variation (-25°C to +85°C)	Pulsed <sup>4</sup> , 2 GHz	$\Delta G$	-	0.02	-	dB/°C
Power Variation (-25°C to +85°C)	Pulsed <sup>4</sup> , 2 GHz	$\Delta P_{2.5dB}$	-	0.01	-	dB/°C
Gain	Pulsed <sup>4</sup> , 2 GHz, $P_{IN} = 41.2\text{ dBm}$	$G_P$	-	14.5	-	dB
Drain Efficiency	Pulsed <sup>4</sup> , 2.0 GHz, $P_{IN} = 41.2\text{ dBm}$	$\eta$	-	57.5	-	%
Ruggedness: Output Mismatch	All phase angles	$\Psi$	VSWR = 10:1, No Damage			

**RF Electrical Specifications:  $T_A = 25^\circ\text{C}$ ,  $V_{DS} = 50\text{ V}$ ,  $I_{DQ} = 200\text{ mA}$**   
**Note: Performance in MACOM Production Test Fixture, 50  $\Omega$  system**

Parameter	Test Conditions	Symbol	Min.	Typ.	Max.	Units
Power Gain	Pulsed <sup>4</sup> , 2 GHz, 2.5 dB Gain Compression	$G_{SAT}$	13	14	-	dB
Saturated Drain Efficiency	Pulsed <sup>4</sup> , 2 GHz, 2.5 dB Gain Compression	$\eta_{SAT}$	52	57.5	-	%
Saturated Output Power	Pulsed <sup>4</sup> , 2 GHz, 2.5 dB Gain Compression	$P_{SAT}$	54	55.4	-	dBm
Gain	Pulsed <sup>4</sup> , 2 GHz, $P_{IN} = 41.2\text{ dBm}$	$G_P$	13	14.2	-	dB
Drain Efficiency	Pulsed <sup>4</sup> , 2 GHz, $P_{IN} = 41.2\text{ dBm}$	$\eta$	52	57.5	-	dB

4. Pulse details: 100  $\mu\text{s}$  pulse width, 1 ms period, 10% Duty Cycle.

**DC Electrical Characteristics (Per Each Side of Symmetric Device)  $T_A = 25^\circ\text{C}$**

Parameter	Test Conditions	Symbol	Min.	Typ.	Max.	Units
Drain-Source Leakage Current	$V_{GS} = -8\text{ V}$ , $V_{DS} = 130\text{ V}$	$I_{DLK}$	-	-	29.2	mA
Gate-Source Leakage Current	$V_{GS} = -8\text{ V}$ , $V_{DS} = 0\text{ V}$	$I_{GLK}$	-	-	29.2	mA
Gate Threshold Voltage	$V_{DS} = 50\text{ V}$ , $I_D = 29.2\text{ mA}$	$V_T$	-2.6	-2.15	-1.6	V
Gate Quiescent Voltage	$V_{DS} = 50\text{ V}$ , $I_D = 150\text{ mA}$	$V_{GSQ}$	-2.4	-2.05	-1.4	V
On Resistance	$V_{GS} = 2\text{ V}$ , $I_D = 200\text{ mA}$	$R_{ON}$	-	0.16	-	$\Omega$
Maximum Drain Current	$V_{DS} = 7\text{ V}$ pulsed, pulse width 300 $\mu\text{s}$	$I_{D, MAX}$	-	17.0	-	A

**Absolute Maximum Ratings (Per Each Side of Symmetric Device)<sup>5,6,7,8,9</sup>**

Parameter	Absolute Maximum
Drain Source Voltage, $V_{DS}$	130 V
Gate Source Voltage, $V_{GS}$	-10 to 3 V
Gate Current, $I_G$	29 mA
Storage Temperature Range	-65°C to +150°C
Case Operating Temperature Range	-40°C to +85°C
Channel Operating Temperature Range, $T_{CH}$	-40°C to +225°C
Absolute Maximum Channel Temperature	+250°C

5. Exceeding any one or combination of these limits may cause permanent damage to this device.
6. MACOM does not recommend sustained operation above maximum operating conditions.
7. Operating at drain source voltage  $V_{DS} < 55$  V will ensure  $MTTF > 1 \times 10^7$  hours.
8. Operating at nominal conditions with  $T_{CH} \leq 225^\circ\text{C}$  will ensure  $MTTF > 1 \times 10^7$  hours.
9. MTTF may be estimated by the expression  $MTTF \text{ (hours)} = A e^{[B + C/(T+273)]}$  where  $T$  is the channel temperature in degrees Celsius,  $A = 3.686$ ,  $B = -35.00$ , and  $C = 25,416$ .

**Thermal Characteristics<sup>10</sup>**

Parameter	Test Conditions	Symbol	Typical	Units
Thermal Resistance using Finite Element Analysis	$V_{DS} = 50$ V, $T_C = 85^\circ\text{C}$ , $T_{CH} = 225^\circ\text{C}$	$R_{\theta}(\text{FEA})$	0.56	°C/W
Thermal Resistance using Infrared Measurement of Die Surface Temperature	$V_{DS} = 50$ V, $T_C = 85^\circ\text{C}$ , $T_{CH} = 225^\circ\text{C}$	$R_{\theta}(\text{IR})$	0.45	°C/W

10. Case temperature measured using thermocouple embedded in heat-sink. Contact local applications support team for more details on this measurement.

**Handling Procedures**

Please observe the following precautions to avoid damage:

**Static Sensitivity**

Gallium Nitride Circuits are sensitive to electrostatic discharge (ESD) and can be damaged by static electricity. Proper ESD control techniques should be used when handling these HBM Class 1A, CDM Class C3 devices.

**Pulsed<sup>4</sup> Load-Pull Performance (Per Each Side of Symmetric Device)  
Reference Plane at Device Leads**

Frequency (GHz)	Z <sub>SOURCE</sub> (Ω)	Maximum Output Power					
		V <sub>DS</sub> = 50 V, I <sub>DQ</sub> = 100 mA, T <sub>C</sub> = 25°C, P <sub>2.5dB</sub>					
		Z <sub>LOAD</sub> <sup>11</sup> (Ω)	Gain (dB)	P <sub>OUT</sub> (dBm)	P <sub>OUT</sub> (W)	η <sub>D</sub> (%)	AM/PM <sup>13</sup> (°)
0.9	5 - j2.0	3.4 - j0.4	19.3	53.5	222.6	58.3	0.3
1.4	5 - j4.6	2.6 - j0.7	16.0	53.3	215.6	62.7	0.5
2.0	5 - j6.3	1.8 - j1.8	14.4	53.5	222.6	61.3	-3.4
2.5	5 - j11.0	1.5 - j3.2	12.9	53.5	222.6	60.6	-6.4
2.7	5 - j11.0	1.9 - j3.8	12.3	53.4	220.9	59.0	-9.6

Frequency (GHz)	Z <sub>SOURCE</sub> (Ω)	Maximum Drain Efficiency					
		V <sub>DS</sub> = 50 V, I <sub>DQ</sub> = 100 mA, T <sub>C</sub> = 25°C, P <sub>2.5dB</sub>					
		Z <sub>LOAD</sub> <sup>12</sup> (Ω)	Gain (dB)	P <sub>OUT</sub> (dBm)	P <sub>OUT</sub> (W)	η <sub>D</sub> (%)	AM/PM <sup>13</sup> (°)
0.9	5 - j2.0	5.4 + j3.0	20.0	52.4	175.5	71.1	-4.8
1.4	5 - j4.6	2.5 + j1.6	17.6	51.9	154.6	74.8	-3.5
2.0	5 - j6.3	1.8 - j1.1	15.0	52.9	195.2	64.3	-3.8
2.5	5 - j11.0	1.4 - j2.3	13.5	52.6	180.0	64.8	-8.5
2.7	5 - j11.0	1.1 - j2.7	13.5	51.8	148.5	65.3	-17.0

**Impedance Reference**

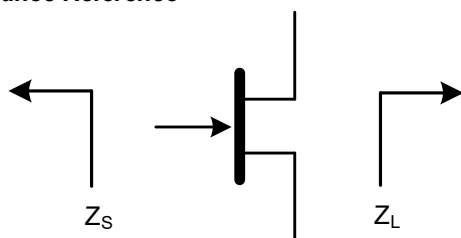

Z<sub>SOURCE</sub> = Measured impedance presented to the input of the device at package reference plane.

Z<sub>LOAD</sub> = Measured impedance presented to the output of the device at package reference plane.

- 11. Load Impedance for optimum output power.
- 12. Load Impedance for optimum efficiency.
- 13. AM/PM are relative values.

**Pulsed<sup>4</sup> Load-Pull Performance (Per Each Side of Symmetric Device)**  
2.0 GHz

**P2.5dB Loadpull Output Power Contours (dBm)**

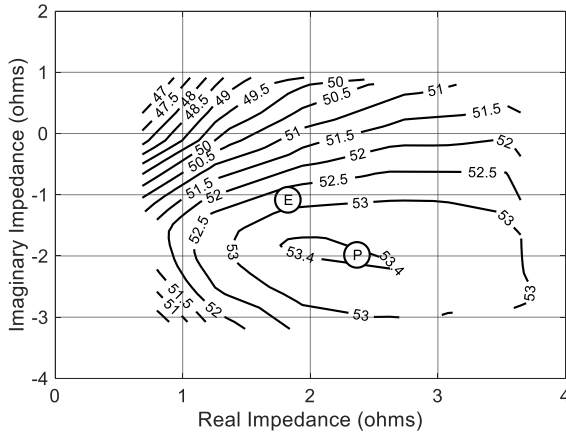

**P2.5dB Loadpull Drain Efficiency Contours (%)**

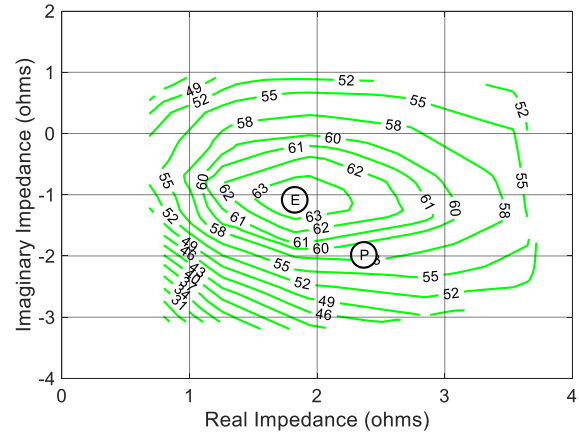

**P2.5dB Loadpull Gain Contours (dB)**

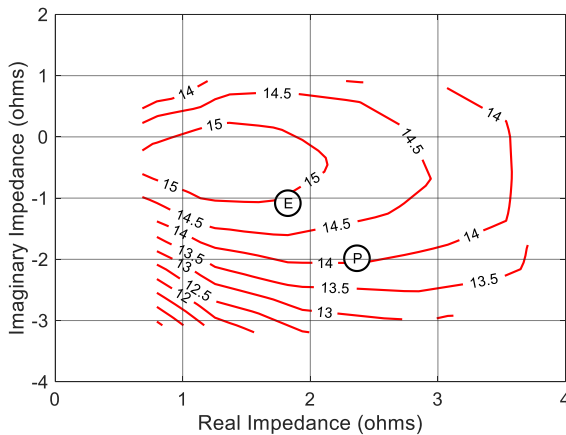

**P2.5dB Loadpull AM/PM Contours (°)**

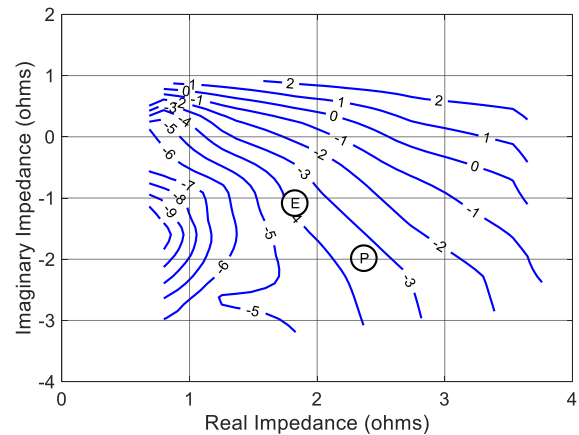

**Gain vs. Output Power**

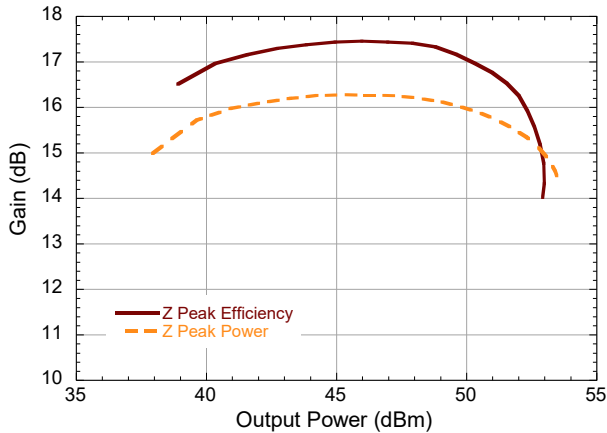

**Drain Efficiency vs. Output Power**

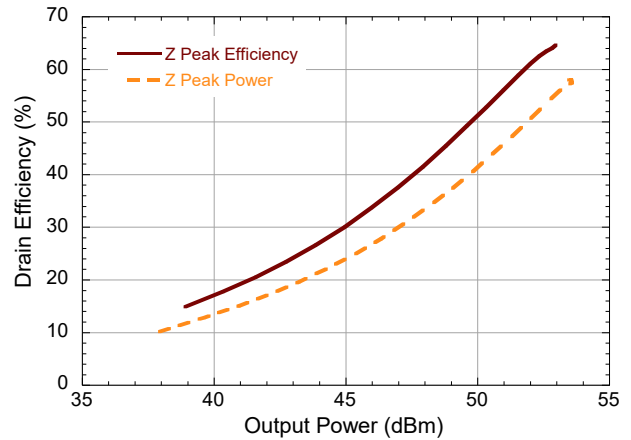

Evaluation Test Fixture and Recommended Tuning Solution 1.95 - 2.05 GHz

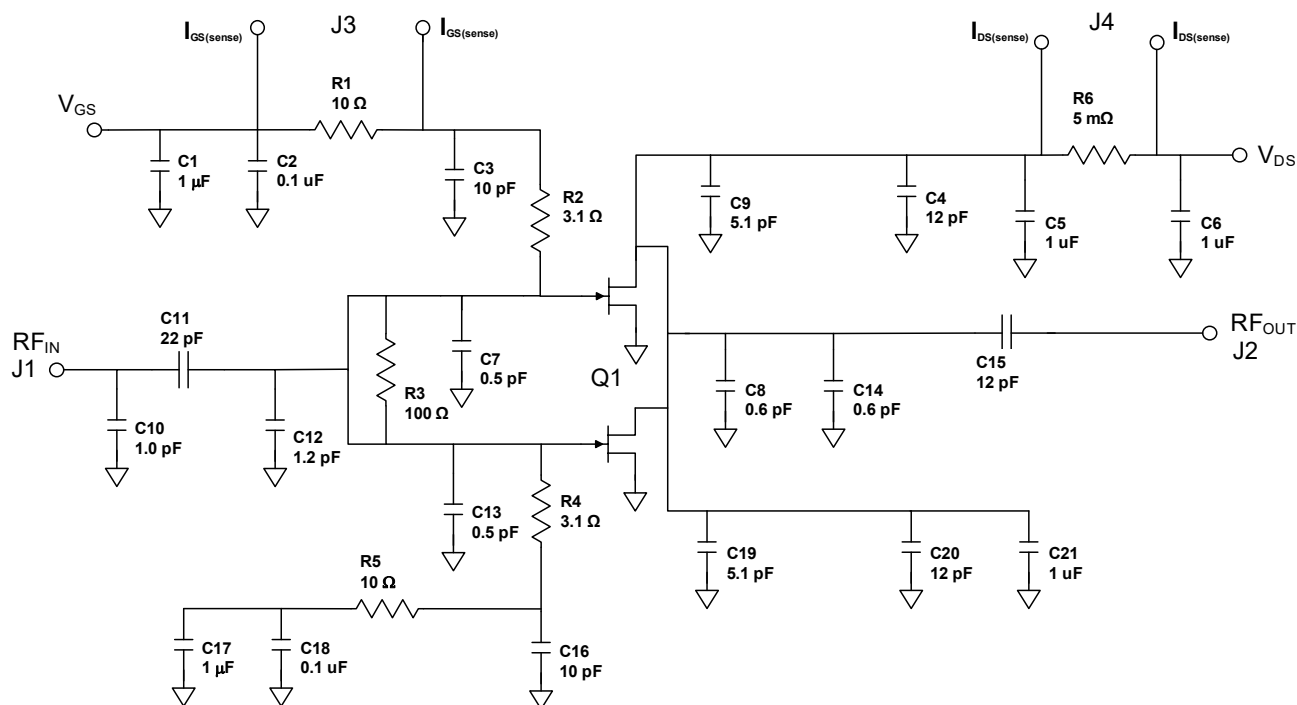

**Description**

Parts measured on evaluation board (20-mil thick RO4350). Matching is provided using a combination of lumped elements and transmission lines as shown in the simplified schematic above. Recommended tuning solution component placement, transmission lines, and details are shown on the next page.

**Bias Sequencing**

**Turning the device ON**

1. Set  $V_{GS}$  to pinch-off ( $V_P$ ).
2. Turn on  $V_{DS}$  to nominal voltage (50 V).
3. Increase  $V_{GS}$  until  $I_{DS}$  current is reached.
4. Apply RF power to desired level.

**Turning the device OFF**

1. Turn the RF power off.
2. Decrease  $V_{GS}$  down to  $V_P$  pinch-off.
3. Decrease  $V_{DS}$  down to 0 V.
4. Turn off  $V_{GS}$ .

Evaluation Test Fixture and Recommended Tuning Solution 1.95 - 2.05 GHz

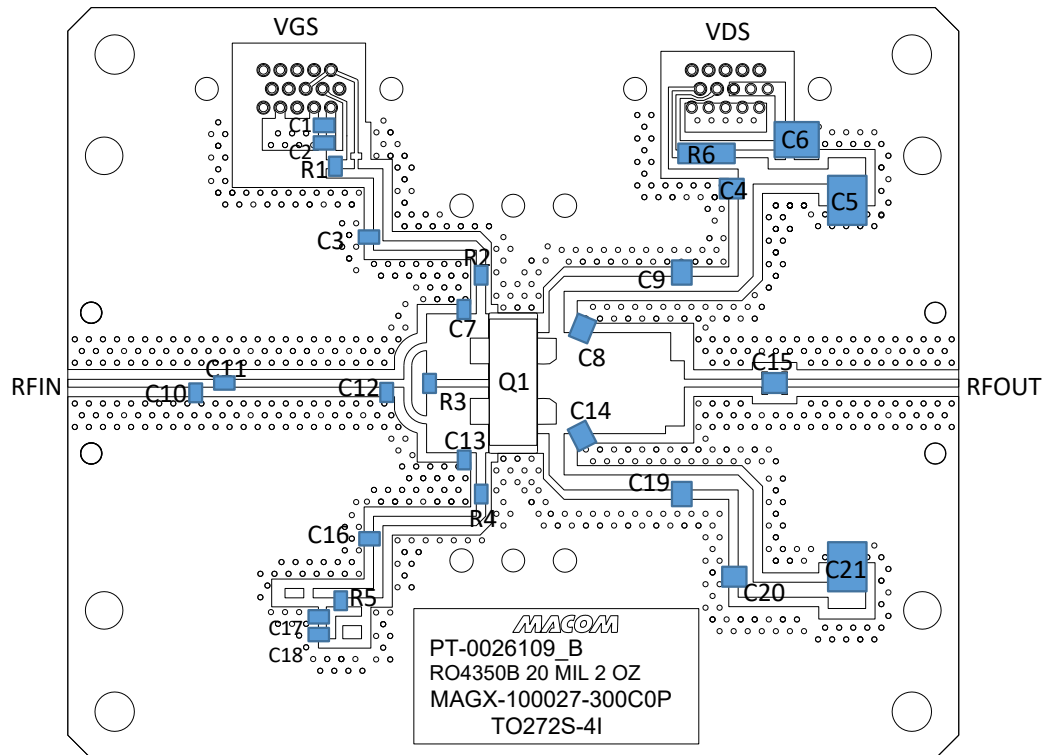

Reference Designator	Value	Tolerance	Manufacturer	Part Number
C1, C18	1.0 $\mu$ F	+/- 10 %	Murata	GRM21BC72A105KE01L
C2, C17	0.1 $\mu$ F	+/- 10 %	Murata	GCD21BR72A104KA01L
C3, C16	10 pF	+/- 0.1 pF	PPI	0505C100BW151X
C4, C15, C20	12 pF	+/- 0.1 pF	PPI	111N120BW501X
C5, C6, C21	1 $\mu$ F	+/- 10 %	Murata	GRM55DR72E105KW01L
C7, C13	0.5 pF	+/- 0.1 pF	PPI	0505C0R5BW151X
C8, C14	0.6 pF	+/- 0.1 pF	PPI	1111N0R6BW501X
C9, C19	5.1 pF	+/- 0.1 pF	PPI	1111N5R1BW501X
C10	1 pF	+/- 0.1 pF	PPI	0505C1R0BW151X
C11	22 pF	+/- 0.1 pF	PPI	0505C220JW151X
C12	1.2 pF	+/- 0.1 pF	PPI	0505C1R2BW151X
R1, R5	10 $\Omega$	+/- 1 %	Vishay Dale	CRCW080510R0FKTA
R2, R4	3.1 $\Omega$	+/- 1 %	Vishay Dale	CRCW08053R09FKEA
R3	100 $\Omega$	+/- 1 %	Vishay Dale	CRCW0805100RFKEA
R6	5 m $\Omega$	+/- 1 %	Susumu	RL7520WT-R005-F
Q1	MACOM GaN Power Amplifier			MAGX-100027-300C0P
PCB	RO4350, 20 mil, 2 oz. Cu, Au Finish			

**Typical Performance Curves as Measured in the 1.95 - 2.05 GHz Evaluation Test Fixture:  
Pulsed<sup>4</sup> 2.0 GHz,  $V_{DS} = 50\text{ V}$ ,  $I_{DQ} = 200\text{ mA}$ ,  $T_c = 25^\circ\text{C}$  (Unless Otherwise Noted)**

**Gain vs. Output Power and Frequency**

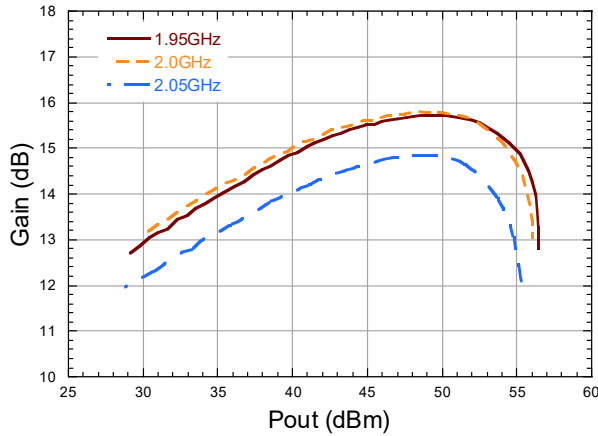

**Drain Efficiency vs. Output Power and Frequency**

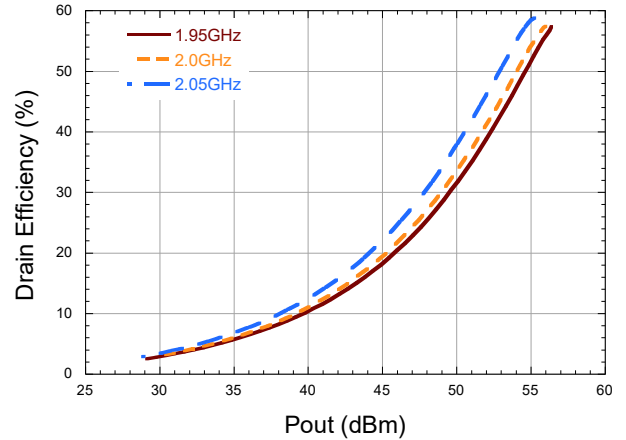

**Gain vs. Output Power and  $V_{DS}$**

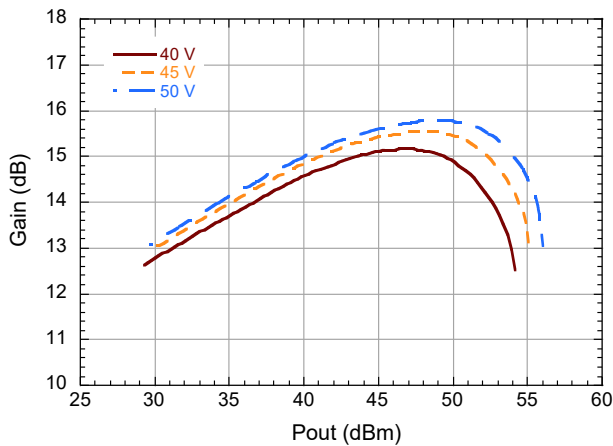

**Drain Efficiency vs. Output Power and  $V_{DS}$**

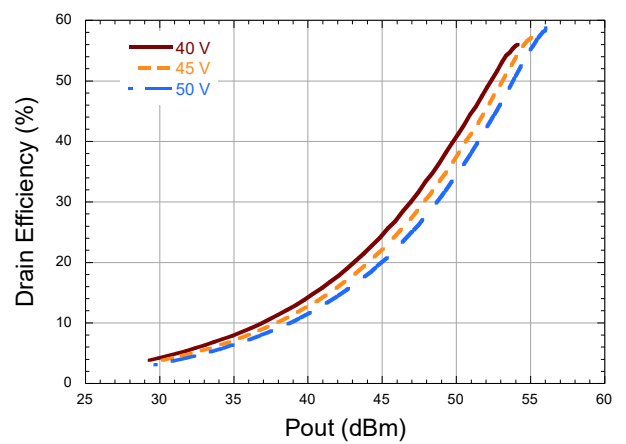

**Gain vs. Output Power and  $I_{DQ}$**

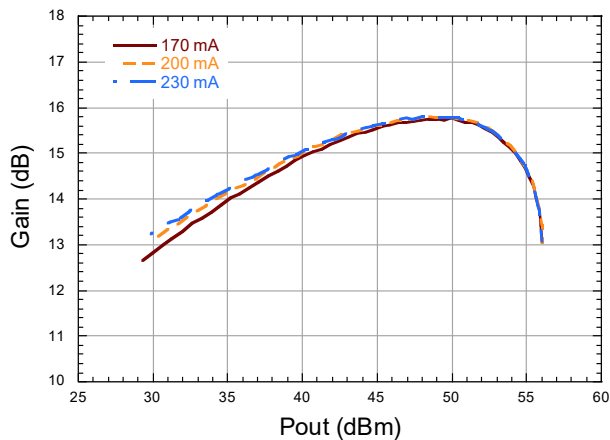

**Drain Efficiency vs. Output Power and  $I_{DQ}$**

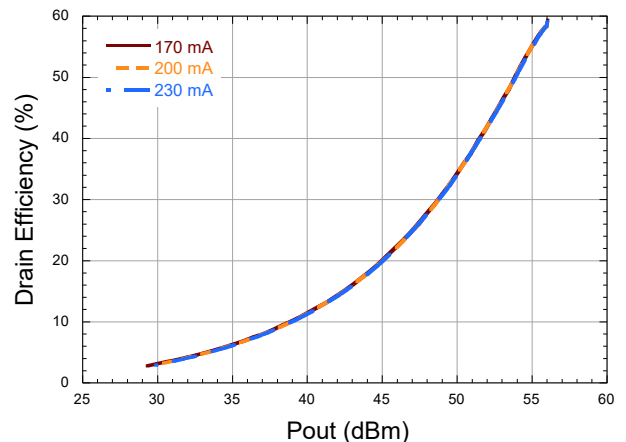



**Typical Performance Curves as Measured in the 1.95 - 2.05 GHz Evaluation Test Fixture:  
Pulsed<sup>4</sup> 2.0 GHz,  $V_{DS} = 50$  V,  $I_{DQ} = 200$  mA,  $T_c = 25^\circ\text{C}$  (Unless Otherwise Noted)**

**Gain vs. Output Power and  $T_c$**

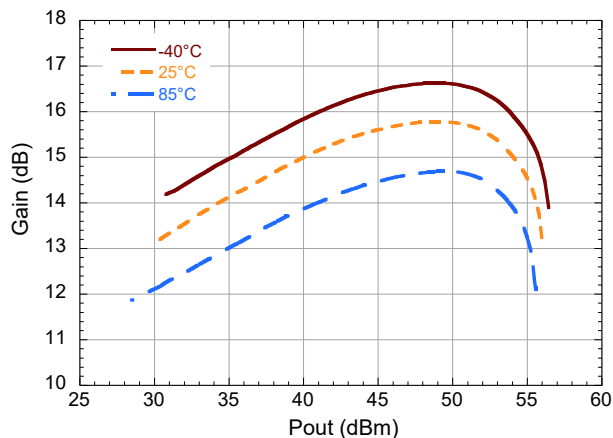

**Drain Efficiency vs. Output Power and  $T_c$**

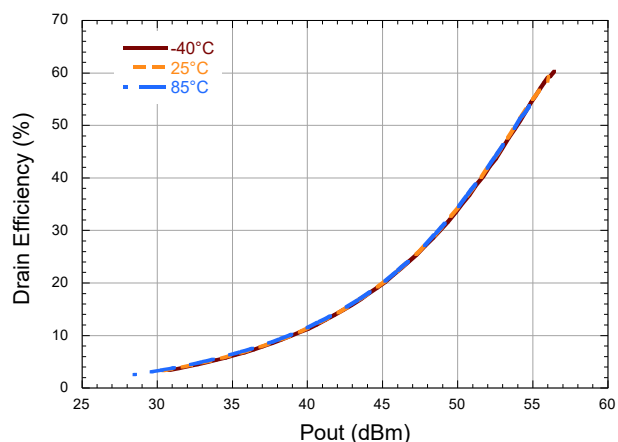

**Gain vs. Frequency**

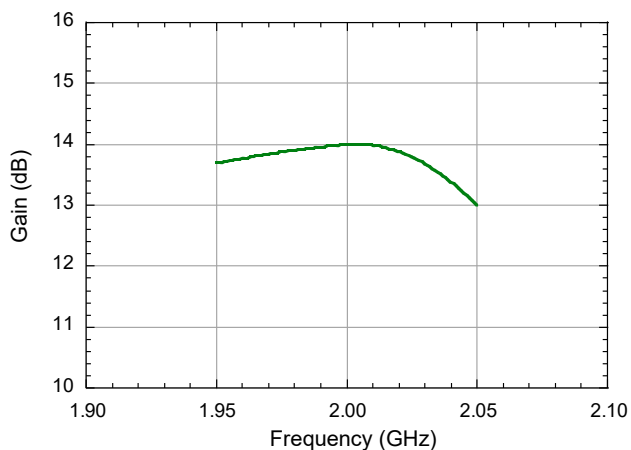

**Drain Efficiency vs. Frequency**

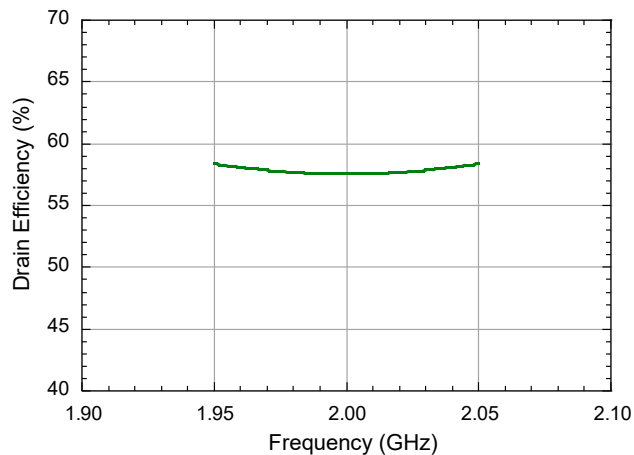

**Output Power vs. Frequency**

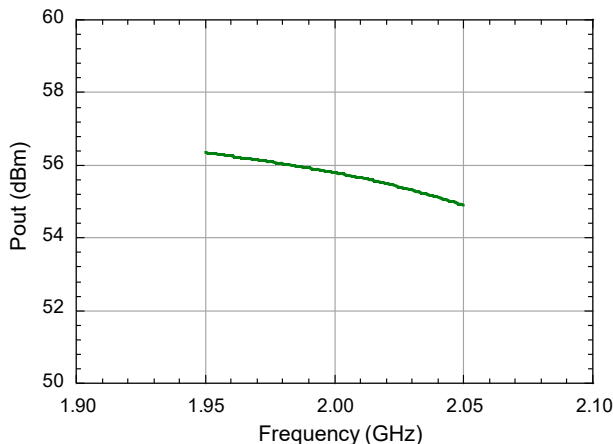

**Lead-Free TO-272S-4I Package Dimensions†**

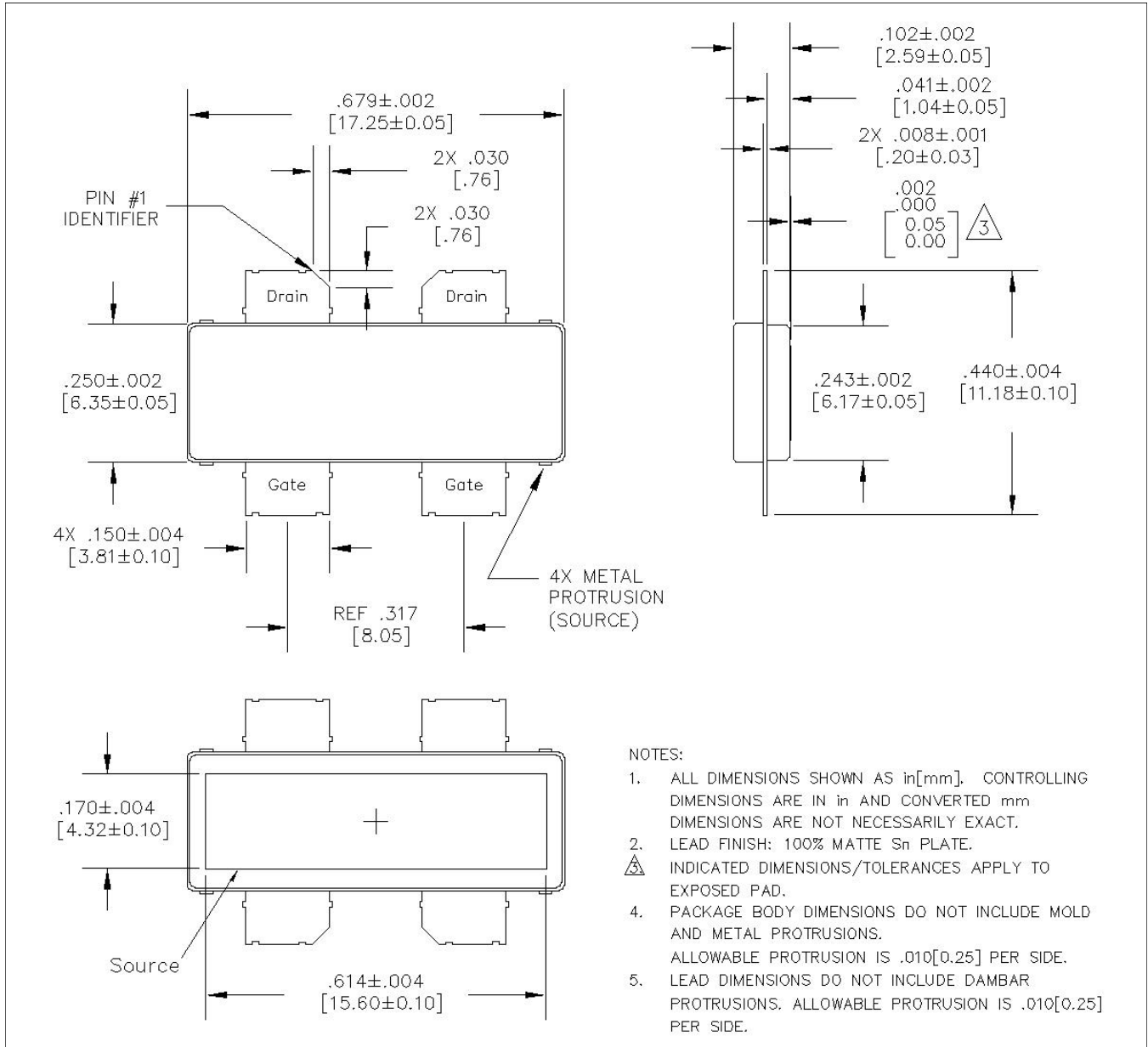

NOTES:

1. ALL DIMENSIONS SHOWN AS in[mm]. CONTROLLING DIMENSIONS ARE IN IN AND CONVERTED mm DIMENSIONS ARE NOT NECESSARILY EXACT.
2. LEAD FINISH: 100% MATTE Sn PLATE.
3. INDICATED DIMENSIONS/TOLERANCES APPLY TO EXPOSED PAD.
4. PACKAGE BODY DIMENSIONS DO NOT INCLUDE MOLD AND METAL PROTRUSIONS. ALLOWABLE PROTRUSION IS .010[0.25] PER SIDE.
5. LEAD DIMENSIONS DO NOT INCLUDE DAMBAR PROTRUSIONS. ALLOWABLE PROTRUSION IS .010[0.25] PER SIDE.

† Reference Application Note AN0004125 for lead-free solder reflow recommendations.  
Meets JEDEC moisture sensitivity level 3 requirements.  
Plating is Matte Sn.

MACOM Technology Solutions Inc. ("MACOM"). All rights reserved.

These materials are provided in connection with MACOM's products as a service to its customers and may be used for informational purposes only. Except as provided in its Terms and Conditions of Sale or any separate agreement, MACOM assumes no liability or responsibility whatsoever, including for (i) errors or omissions in these materials; (ii) failure to update these materials; or (iii) conflicts or incompatibilities arising from future changes to specifications and product descriptions, which MACOM may make at any time, without notice. These materials grant no license, express or implied, to any intellectual property rights.

THESE MATERIALS ARE PROVIDED "AS IS" WITH NO WARRANTY OR LIABILITY, EXPRESS OR IMPLIED, RELATING TO SALE AND/OR USE OF MACOM PRODUCTS INCLUDING FITNESS FOR A PARTICULAR PURPOSE, MERCHANTABILITY, INFRINGEMENT OF INTELLECTUAL PROPERTY RIGHT, ACCURACY OR COMPLETENESS, OR SPECIAL, INDIRECT, INCIDENTAL, OR CONSEQUENTIAL DAMAGES WHICH MAY RESULT FROM USE OF THESE MATERIALS.

MACOM products are not intended for use in medical, lifesaving or life sustaining applications. MACOM customers using or selling MACOM products for use in such applications do so at their own risk and agree to fully indemnify MACOM for any damages resulting from such improper use or sale.