

10 9 8 7 6 5 4 3 2 1

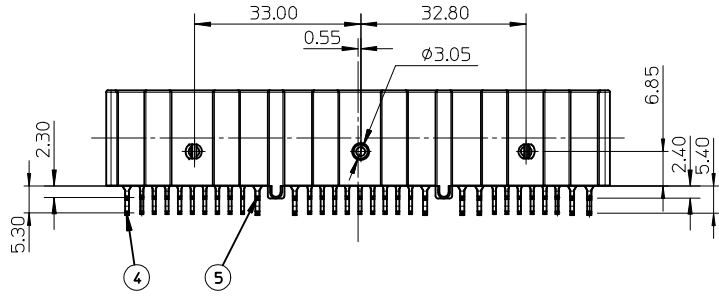
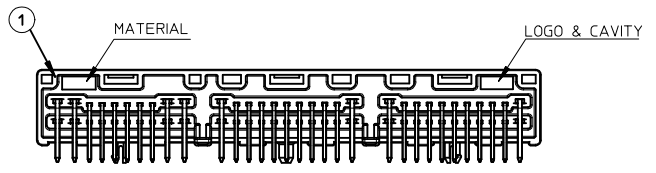
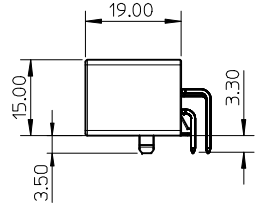
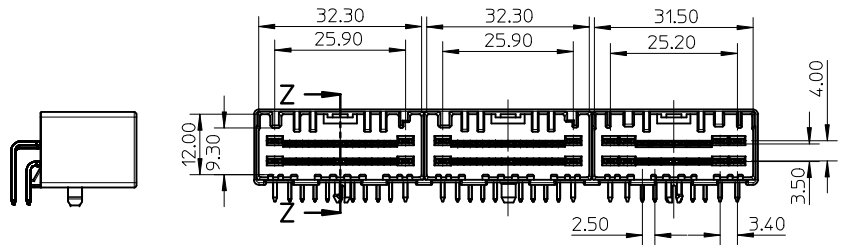
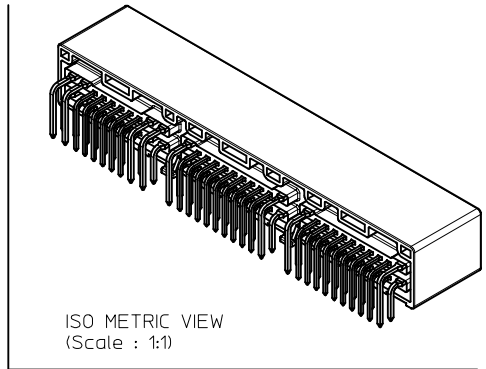
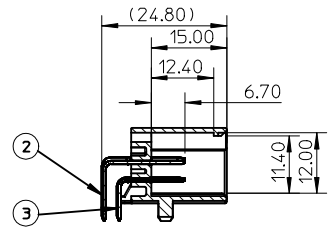
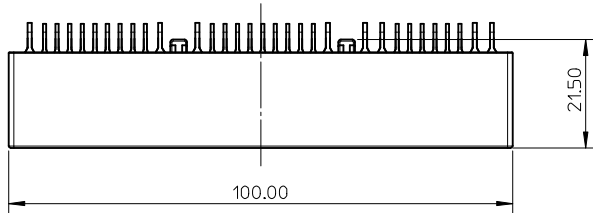

NOTES

- 1. APPLICABLE FEMALE HOUSING : 104213-2011, 104213-2211, 104213-2221
- 2. GENERAL TOLERANCE : SEE TABLE
- 3. PCB THICKNESS : 1.6 (REFERENCE)

NO	DESCRIPTION	MATERIAL	FINISH		Q'TY
			SOLDER SIDE	CONTACT SIDE	
1	025 060 HEADER HOUSING 64P	PBT-GF30	-	-	1
2	025 MALE TERMINAL - L	BRASS	SELECTIVE TIN (POST)	PRE-TIN	24
3	025 MALE TERMINAL - S	BRASS	SELECTIVE TIN (POST)	PRE-TIN	24
4	060 MALE TERMINAL - L	BRASS	SELECTIVE TIN (POST)	PRE-TIN	8
5	060 MALE TERMINAL - S	BRASS	SELECTIVE TIN (POST)	PRE-TIN	8

MATERIAL NO	ORDER NO	COLOR
1042126411	104212-6411	BLACK

PCB LAYOUT (MNT SIDE)_RECOMMENDED

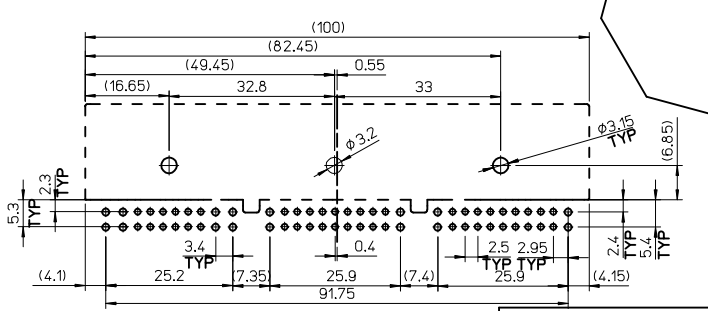

General Tolerance : +0.05

ENTER DESCRIPTION
 EC NO: KTR2015-0077
 DRWN: JWK1M02 2015/05/14
 CHKD:
 APPR: JYCH01 2015/05/15
 REV

QUALITY SYMBOLS	GENERAL TOLERANCES (UNLESS SPECIFIED)	DIMENSION STYLE	SCALE	DESIGN UNITS	THIRD ANGLE PROJECTION
$F_{\Delta} = 0$	mm INCH	MM ONLY	1:1	METRIC	THIRD ANGLE PROJECTION
$F_{\square} = 0$	4 PLACES ± --- ± ---	DRAWN BY	DATE	TITLE	
$F_{\circ} = 0$	3 PLACES ± --- ± ---	JWK1M02	2015/05/14	025 060 HEADER ASSY 64P (R/A TYPE)	
$F_{\nabla} = 0$	2 PLACES ± 0.25 ± ---	CHECKED BY	DATE	SD-104212-001	
	1 PLACE ± 0.3 ± ---	BCYOON		SHEET NO. 1 OF 1	
	0 PLACE ± --- ± ---	APPROVED BY	DATE	THIS DRAWING CONTAINS INFORMATION THAT IS PROPRIETARY TO MOLEX INCORPORATED AND SHOULD NOT BE USED WITHOUT WRITTEN PERMISSION	
	ANGULAR ± 1 °	JYCH01	2015/05/15		
	DRAFT WHERE APPLICABLE MUST REMAIN WITHIN DIMENSIONS	MATERIAL NO.	DOCUMENT NO.		
		SEE NOTE			

9 8 7 6 5 4 3 2 1