

REVISIONS					
P	LTR	DESCRIPTION	DATE	DWN	APVD
G		REVISE PER ECN-23-202670	21MAR2023	LP	JW

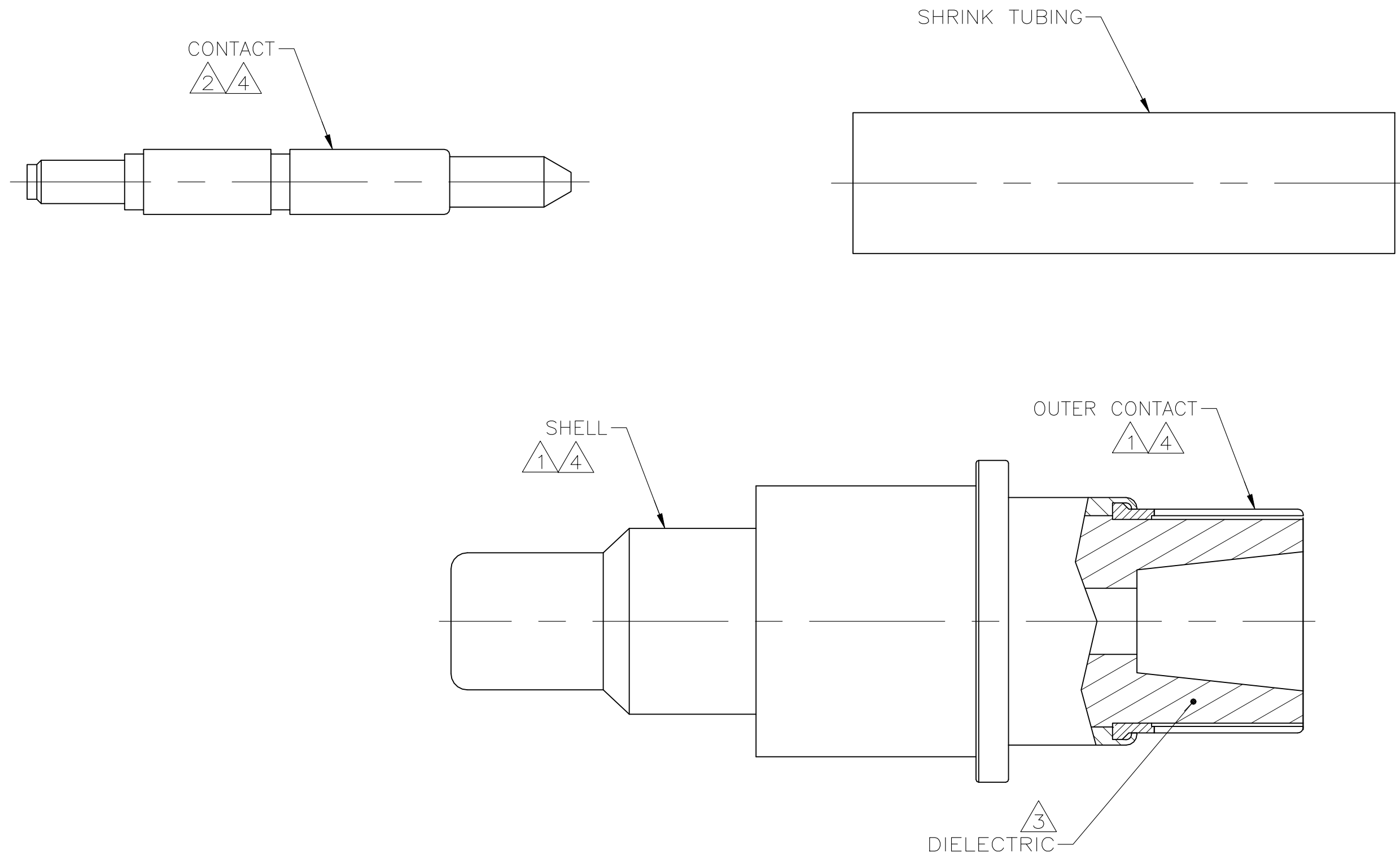

- 1 BRASS PER ASTM-B-16.
 - 2 BERYLLIUM COPPER PER ASTM-B-196.
 - 3 PTFE PER ASTM-D-1710.
 - 4 GOLD PLATED PER ASTM-B-488 OVER NICKEL PER QQ-N-290.
5. FOR USE WITH .141 [3.58] SEMI-RIGID CABLE.
 6. CONTACT FINGERS BeCu PER ASTM-B-196.

WARNING - THIS DOCUMENT CONTAINS TECHNOLOGY WHOSE EXPORT IS RESTRICTED BY THE EXPORT ADMINISTRATION REGULATIONS ("EAR") PURSUANT TO 15 C.F.R. PARTS 730-774. VIOLATIONS OF THE EAR ARE SUBJECT TO SEVERE CRIMINAL PENALTIES UNDER THE EXPORT CONTROL REFORM ACT, AS AMENDED (TITLE 50, U.S.C., SEC. 4801, ET SEQ.).

225837-1
PART NO.

THIS DRAWING IS A CONTROLLED DOCUMENT.		DWN C.C.THOMAS 10-31-94																						
DIMENSIONS: INCHES		CHK J.CABARLO 11-2-94																						
TOLERANCES UNLESS OTHERWISE SPECIFIED:		APVD J.CABARLO 11-2-94	NAME PIN CONTACT KIT, SIZE 1, RF																					
<table border="1"> <tr><td>0 PLC</td><td>±</td><td>-</td></tr> <tr><td>1 PLC</td><td>±</td><td>-</td></tr> <tr><td>2 PLC</td><td>±</td><td>-</td></tr> <tr><td>3 PLC</td><td>±</td><td>.005 [0.13]</td></tr> <tr><td>4 PLC</td><td>±</td><td>-</td></tr> <tr><td>ANGLES</td><td>±</td><td>-</td></tr> </table>		0 PLC	±	-	1 PLC	±	-	2 PLC	±	-	3 PLC	±	.005 [0.13]	4 PLC	±	-	ANGLES	±	-	PRODUCT SPEC -	SIZE A2	CAGE CODE 00779	DRAWING NO C=225837	RESTRICTED TO -
0 PLC	±	-																						
1 PLC	±	-																						
2 PLC	±	-																						
3 PLC	±	.005 [0.13]																						
4 PLC	±	-																						
ANGLES	±	-																						
MATERIAL SEE CALLOUTS		FINISH SEE CALLOUTS	WEIGHT -	SCALE 5:1	SHEET 1 of 1	REV G																		
CUSTOMER DRAWING																								