

TOLERANCE UNLESS OTHERWISE SPECIFIED	
.X	±0.25
.XX	±0.13
.XXX	±0.05

THIS IS A C.A.D. GENERATED DRAWING
DO NOT MAKE MANUAL REVISIONS TO MASTER.

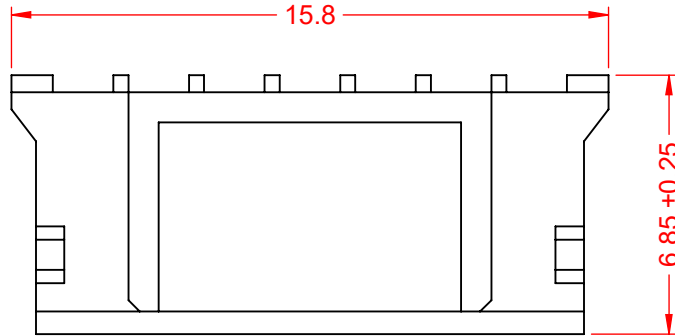

ISSUE NUMBER	
ORIGINAL	①



NOTES:
 CURRENT RATING: 2A AC/DC
 VOLTAGE RATING: 100V AC/DC
 TEMPERATURE RATING: -25°C ~ 85°C
 (CONTACT RESISTANCE: 10mΩ MAX.)
 HOUSING RESISTANCE: 1000MΩ min.
 WITHSTANDING VOLTAGE: 800V AC / 60s
 HOUSING MATERIAL: NYLON PA66, UL94V-0

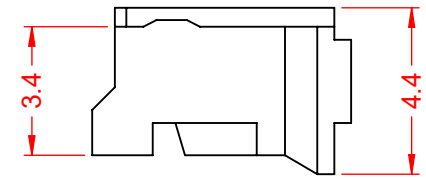
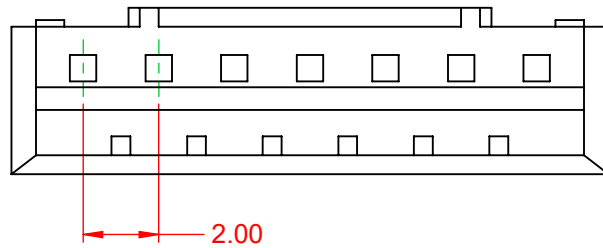

140 SERIES FEMALE CRIMP CONTACT HOUSING

ACAD REFERENCE NO.: 140 Assembly	
DRAWN: C.B	DATE: April 3, 2020
CHECKED:	DATE:
SCALE: 5:1	SHEET 1 OF 1
DRAWING NUMBER: 140 Assembly	ISSUE
PART NUMBER: 140-507-210-011	1



THIS SERIES FULLY CONFORMS TO
THE EUROPEAN UNION DIRECTIVES
2011/65/EU FOR RoHS COMPLIANCY.



YOUR CONNECTION TO QUALITY & SERVICE

EDAC INC
TORONTO, ONTARIO
CANADA

THESE DRAWINGS AND SPECIFICATIONS
ARE THE PROPERTY OF EDAC INC., AND
SHALL NOT BE REPRODUCED, OR COPIED
OR USED AS THE BASIS FOR THE
MANUFACTURE OR SALE OF APPARATUS
WITHOUT WRITTEN PERMISSION.