

PCB terminal block - SMKDS 1/ 9-3,5 - 1751167

Please be informed that the data shown in this PDF Document is generated from our Online Catalog. Please find the complete data in the user's documentation. Our General Terms of Use for Downloads are valid (<http://phoenixcontact.com/download>)

PCB terminal block, nominal current: 10 A, pitch: 3.5 mm, number of positions: 9, connection method: Screw connection with tension sleeve, mounting: Wave soldering, conductor/PCB connection direction: 35 °, color: green



The figure shows a 10-position version of the product

Your advantages

- ✓ Well-known connection principle allows worldwide use
- ✓ Low temperature rise, thanks to maximum contact force
- ✓ Allows connection of two conductors
- ✓ Angled connection enables multi-row arrangement on the PCB
- ✓ Extremely small design for the respective conductor cross section

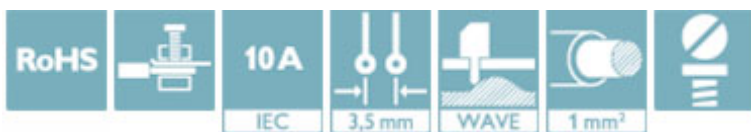

Key Commercial Data

Packing unit	100 pc
GTIN	 4 017918 103767
GTIN	4017918103767

Technical data

Dimensions

Length [l]	10 mm
Pitch	3.5 mm
Dimension a	28 mm
Width [w]	32 mm
Height	9.5 mm
Height [h]	13 mm
Solder pin [P]	3.5 mm
Hole diameter	1.1 mm

General

Range of articles	SMKDS 1
-------------------	---------

PCB terminal block - SMKDS 1/ 9-3,5 - 1751167

Technical data

General

Insulating material group	I
Rated surge voltage (III/3)	2.5 kV
Rated surge voltage (III/2)	2.5 kV
Rated surge voltage (II/2)	2.5 kV
Rated voltage (III/3)	160 V
Rated voltage (III/2)	200 V
Rated voltage (II/2)	400 V
Connection in acc. with standard	EN-VDE
Nominal current I _N	10 A
Nominal cross section	1 mm ²
Maximum load current	12 A
Insulating material	PA
Flammability rating according to UL 94	V0
Stripping length	5 mm
Number of positions	9
Screw thread	M2
Tightening torque, min	0.22 Nm
Tightening torque max	0.25 Nm

Connection data

Conductor cross section solid min.	0.14 mm ²
Conductor cross section solid max.	1.5 mm ²
Conductor cross section flexible min.	0.14 mm ²
Conductor cross section flexible max.	1 mm ²
Conductor cross section flexible, with ferrule without plastic sleeve min.	0.25 mm ²
Conductor cross section flexible, with ferrule without plastic sleeve max.	0.5 mm ²
Conductor cross section flexible, with ferrule with plastic sleeve min.	0.25 mm ²
Conductor cross section flexible, with ferrule with plastic sleeve max.	0.5 mm ²
Conductor cross section AWG min.	26
Conductor cross section AWG max.	16
2 conductors with same cross section, solid min.	0.14 mm ²
2 conductors with same cross section, solid max.	0.5 mm ²
2 conductors with same cross section, stranded min.	0.14 mm ²
2 conductors with same cross section, stranded max.	0.2 mm ²

Standards and Regulations

Connection in acc. with standard	EN-VDE
	CSA
Flammability rating according to UL 94	V0

Environmental Product Compliance

	Lead 7439-92-1
--	----------------

PCB terminal block - SMKDS 1/ 9-3,5 - 1751167

Technical data

Environmental Product Compliance

China RoHS	Environmentally Friendly Use Period = 50
	For details about hazardous substances go to tab "Downloads", Category "Manufacturer's declaration"

Drawings

Drilling diagram

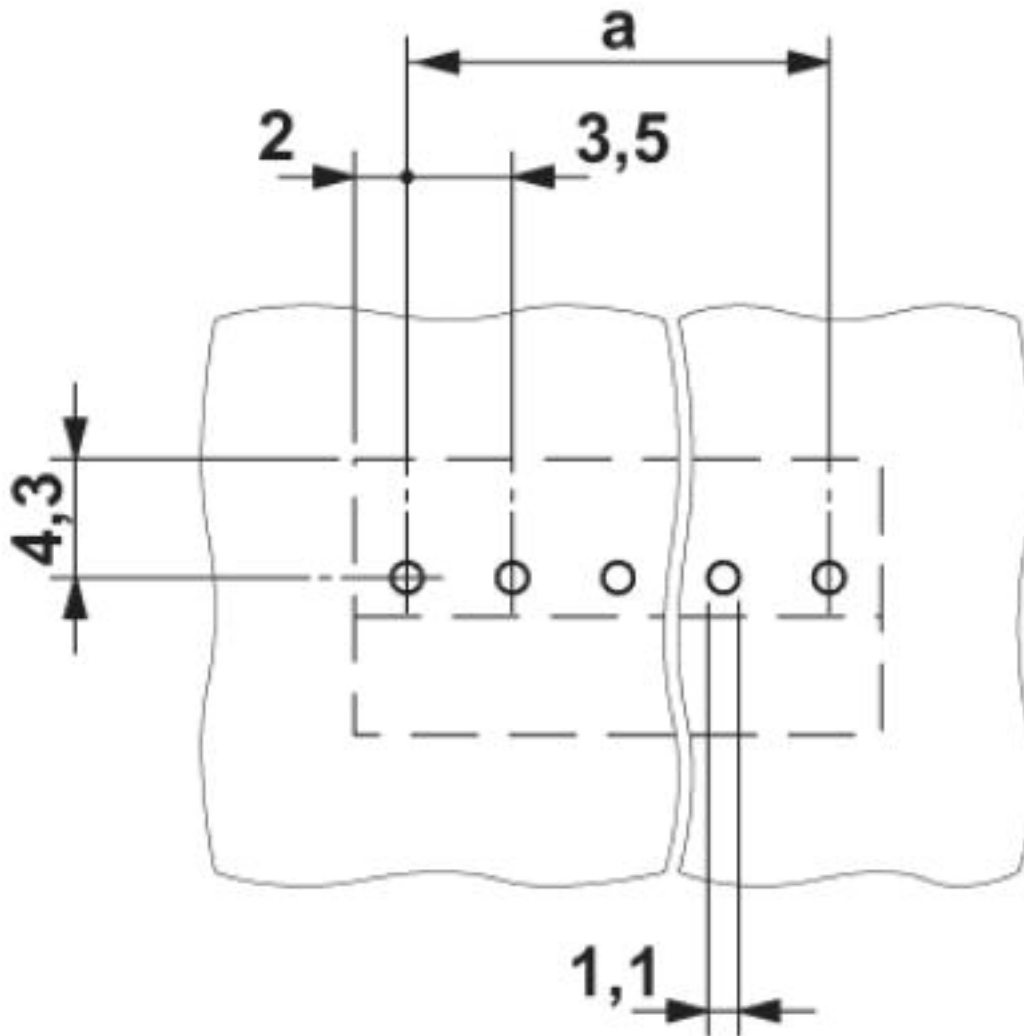

PCB terminal block - SMKDS 1/ 9-3,5 - 1751167

Diagram

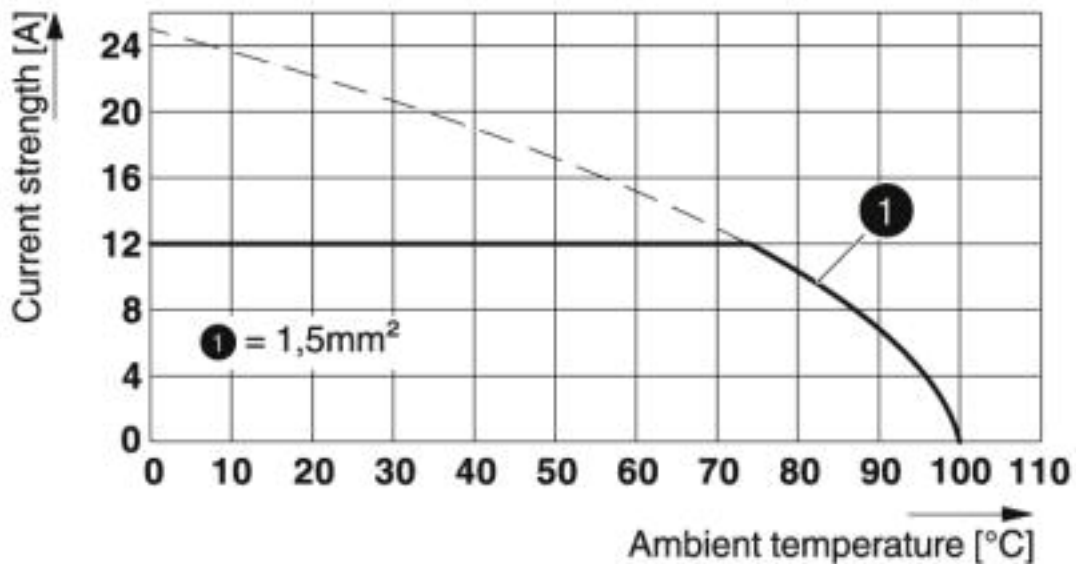

Type: SMKDS 1/5-3,5
Tested according to DIN EN 60512-5-2:2003-01
Reduction factor = 1
Number of positions: 5

Dimensional drawing

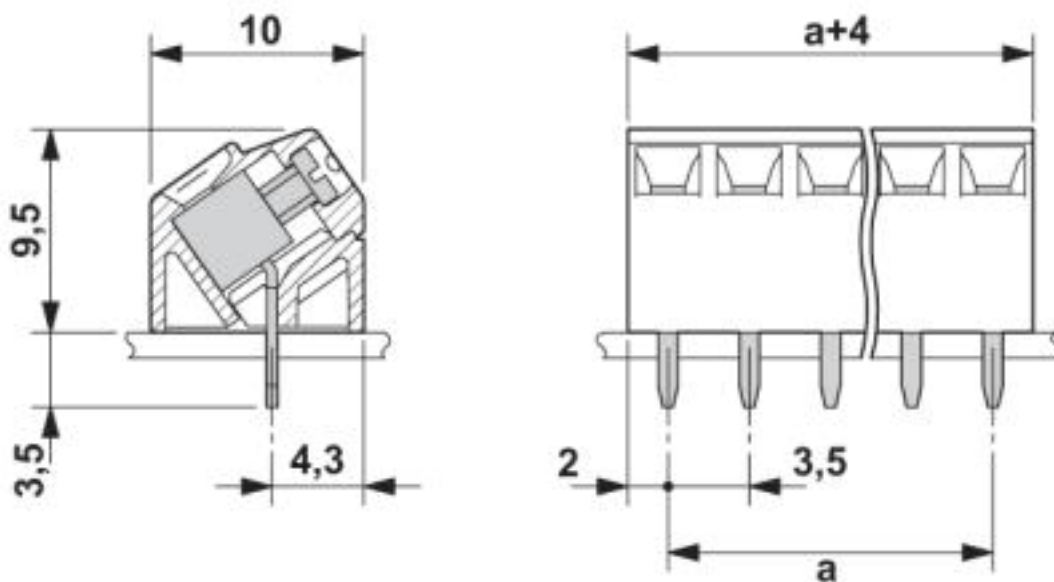

Approvals

Approvals

PCB terminal block - SMKDS 1/ 9-3,5 - 1751167

Approvals

Approvals

CSA / IECCEB CB Scheme / SEV / EAC / cULus Recognized

Ex Approvals

Approval details

CSA		http://www.csagroup.org/services-industries/product-listing/	13631
		B	D
Nominal voltage UN		150 V	300 V
Nominal current IN		10 A	10 A
mm ² /AWG/kcmil		28-16	28-16

IECEE CB Scheme		http://www.iecee.org/	CH-8225
Nominal voltage UN		125 V	
Nominal current IN		12 A	
mm ² /AWG/kcmil		1.5	

SEV		https://www.electrosuisse.ch/de/meta/shop/produktezertifikate.html	IK-3542-M1
Nominal voltage UN		125 V	
Nominal current IN		12 A	
mm ² /AWG/kcmil		1.5	

EAC			B.01742
-----	---	--	---------

cULus Recognized		http://database.ul.com/cgi-bin/XYV/template/LISEXT/1FRAME/index.htm	E60425-19770427
		B	D
Nominal voltage UN		300 V	300 V

PCB terminal block - SMKDS 1/ 9-3,5 - 1751167

Approvals

	B	D
Nominal current IN	10 A	10 A
mm ² /AWG/kcmil	30-16	30-16

Phoenix Contact 2019 © - all rights reserved
<http://www.phoenixcontact.com>

PHOENIX CONTACT GmbH & Co. KG
Flachsmarktstr. 8
32825 Blomberg
Germany
Tel. +49 5235 300
Fax +49 5235 3 41200
<http://www.phoenixcontact.com>