

Surface Mount Directional Coupler

50Ω 10 to 500 MHz

ADC-26-52+



Generic photo used for illustration purposes only

CASE STYLE: CD636

+RoHS Compliant

The +Suffix identifies RoHS Compliance. See our web site for RoHS Compliance methodologies and qualifications

Available Tape and Reel at no extra cost

Reel Size	Devices/Reel
7"	20, 50, 100, 200
13"	500, 1000

Maximum Ratings

Operating Temperature	-40°C to 85°C
Storage Temperature	-55°C to 100°C

Permanent damage may occur if any of these limits are exceeded.

Pin Connections

INPUT	1
OUTPUT	6
COUPLED	3
GROUND	2
50Ω TERM EXTERNAL	4
ISOLATE (DO NOT USE)	5

Outline Drawing

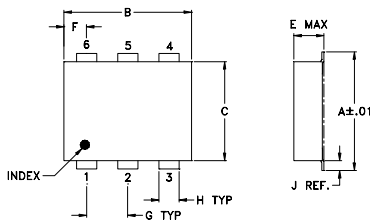

PCB Land Pattern

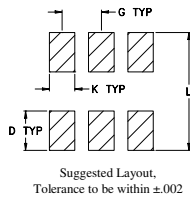

Outline Dimensions (inch/mm)

A	B	C	D	E	F	G
.272	.310	.220	.100	.162	.055	.100
6.91	7.87	5.59	2.54	4.11	1.40	2.54
H	J	K	L	wt		
.030	.026	.065	.300	grams		
0.76	0.66	1.65	7.62	0.25		

Demo Board MCL P/N: TB-05 Suggested PCB Layout (PL-095)

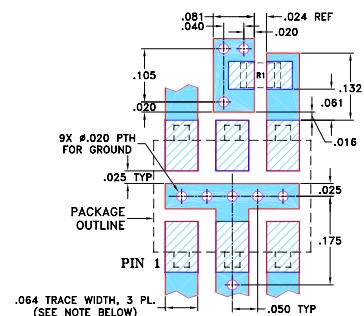

RESISTOR R1: 49.9 Ohm, 0805 SIZE.

- NOTES: 1. TRACE WIDTH IS SHOWN FOR ROGERS RO4350B WITH DIELECTRIC THICKNESS .030" ± .002"; COPPER: 1/2 OZ. EACH SIDE. FOR OTHER MATERIALS TRACE WIDTH MAY NEED TO BE MODIFIED.
2. BOTTOM SIDE OF THE PCB IS CONTINUOUS GROUND PLANE.
DENOTES PCB COPPER LAYOUT WITH SMOBC (SOLDER MASK OVER BARE COPPER)
DENOTES COPPER LAND PATTERN FREE OF SOLDER MASK

Notes

- A. Performance and quality attributes and conditions not expressly stated in this specification document are intended to be excluded and do not form a part of this specification document.
B. Electrical specifications and performance data contained in this specification document are based on Mini-Circuits' applicable established test performance criteria and measurement instructions.
C. The parts covered by this specification document are subject to Mini-Circuits standard limited warranty and terms and conditions (collectively, "Standard Terms"); Purchasers of this part are entitled to the rights and benefits contained therein. For a full statement of the Standard Terms and the exclusive rights and remedies thereunder, please visit Mini-Circuits' website at www.minicircuits.com/MCLStore/terms.jsp

Features

- wideband, 10-500 MHz
- low insertion loss, 0.2 dB typ.
- high directivity, 21 dB typ.
- aqueous washable
- protected by U.S. Patents 6,133,525 & 6,140,887

Applications

- VHF/UHF
- reflective power measurements
- communications
- signal sampling

Directional Coupler Electrical Specifications

FREQ. RANGE (MHz)	COUPLING (dB)		MAINLINE LOSS ¹ (dB)			DIRECTIVITY (dB)			VSWR (:1)	POWER INPUT ² (W)							
	Nom.	Typ. Flatness	L Typ.	M Typ.	U Typ.	L Typ.	M Typ.	U Typ.		LM Max.	U Max.						
f _c -f _u																	
10-500	26.0±0.5	±0.9	0.15	0.35	0.2	0.3	0.3	0.5	35	22	25	16	18	11	1.1	2.0	5

L= 10-100 MHz M= 100-250 MHz U= 250-500 MHz

1. Mainline loss includes theoretical power loss at coupled port.

2. Derate linearly to 0.5 Watt for "L, M" band and 1 Watt for "U" band at 85°C.

Typical Performance Data

Frequency (MHz)	Mainline Loss (dB)		Coupling (dB)	Directivity (dB)	Return Loss (dB)		
	In-Out	In-Cpl			In	Out	Cpl
10.00	0.14	26.49	33.14	31.50	31.90	31.60	
50.00	0.12	26.51	33.50	35.75	36.35	35.18	
100.00	0.12	26.48	27.68	34.14	34.71	33.55	
150.00	0.13	26.41	24.27	32.10	32.76	31.53	
200.00	0.15	26.29	21.96	30.57	31.12	29.61	
250.00	0.16	26.14	20.19	29.15	29.75	27.93	
300.00	0.18	25.97	18.67	27.68	28.08	26.51	
350.00	0.20	25.77	17.46	26.65	27.05	25.29	
400.00	0.22	25.56	16.37	25.73	25.86	24.24	
500.00	0.27	25.14	14.54	24.41	24.06	22.45	

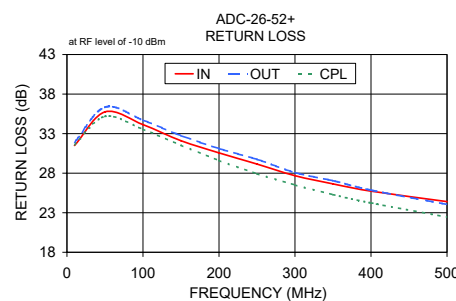
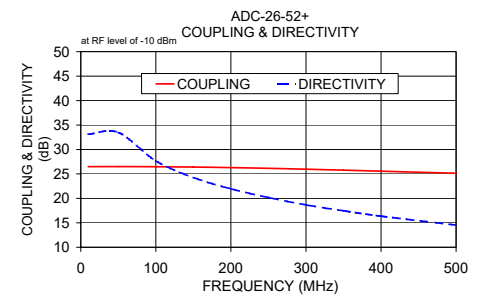
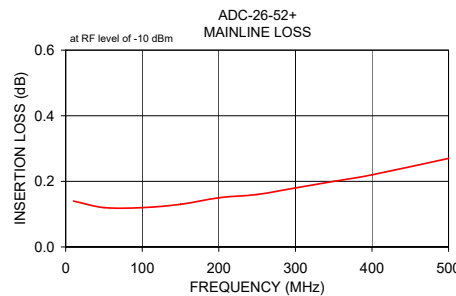

Electrical Schematic

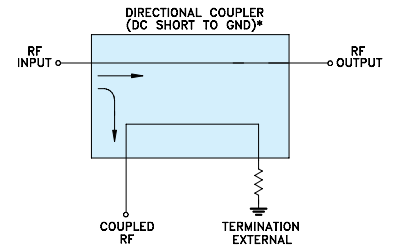

* ELECTRICAL SCHEMATIC IS FOR DIRECTIONAL COUPLER WITH INTERNAL TRANSFORMER(S) AND EXTERNAL TERMINATION.

