



APPLICATION SPECIFICATION

TITLE

RECTANGULAR STANDARD NFC ANTENNA

TABLE OF CONTENTS

- 1.0 SCOPE
- 2.0 PRODUCT DESCRIPTION
- 3.0 APPLICABLE DOCUMENTS
- 4.0 ANTENNA PERFORMANCE
- 5.0 MATCHING NETWORK DESCRIPTION
- 6.0 DETECTION DISTANCE TEST

REVISION: B2	ECR/ECN INFORMATION: EC No: 663046 DATE: 2021/05/06	TITLE: Rectangular Standard NFC Antenna Application Specification	SHEET No. 1 of 22
DOCUMENT NUMBER: AS-1462360001	CREATED / REVISED BY: Liu Hai 2021/03/17	CHECKED BY: Cheng Kang 2021/03/17	APPROVED BY: Andy Zhang 2021/03/17

RECTANGULAR STANDARD NFC ANTENNA

1.0 SCOPE

This specification describes the antenna application and surrounding. The information in this document is for reference and benchmark purposes only.

Antenna illustrations in this document are generic representations. They are not intended to be an image of any antenna listed in the scope.

2.0 PRODUCT DESCRIPTION

2.1 PRODUCT NAME AND SERIES NUMBER (S)

Product name: Rectangular Standard NFC Antenna

Series Number: 146236

2.2 DESCRIPTION

Series 146236 is rectangular, flexible, NFC (Near Field Communication) antennas for use in applications like payment system, boarding pass, tagging reader, access control system...

2.3 PRODUCT STRUCTURE INFORMATION

- Please refer to PS-1462360001 for full information.



Molex 14623600XX RECTANGLE STANDARD NFC MODULE 3D VIEW

REVISION: B2	ECR/ECN INFORMATION: EC No: 663046 DATE: 2021/05/06	TITLE: Rectangular Standard NFC Antenna Application Specification	SHEET No. 2 of 22
DOCUMENT NUMBER: AS-1462360001	CREATED / REVISED BY: Liu Hai 2021/03/17	CHECKED BY: Cheng Kang 2021/03/17	APPROVED BY: Andy Zhang 2021/03/17



Molex 1462360XXX RECTANGLE STANDARD NFC WITH FERRITE MODULE 3D VIEW

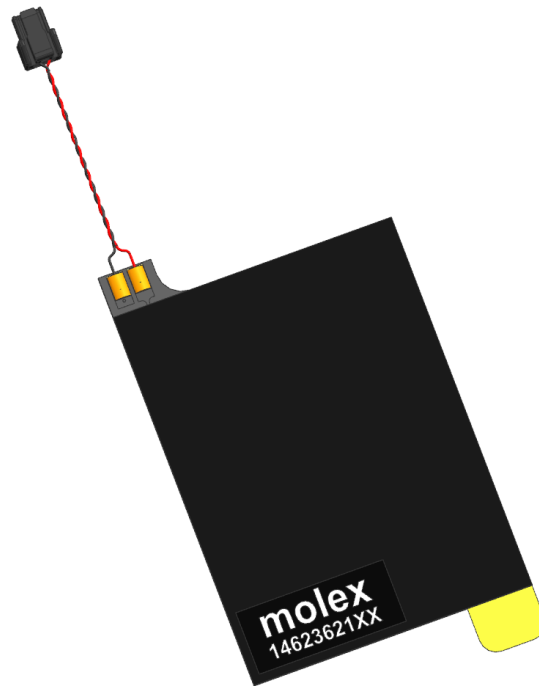

Molex 14623621XX RECTANGLE STANDARD NFC WITH AWG28 WIRE MODULE 3D VIEW

REVISION: B2	ECR/ECN INFORMATION: EC No: 663046 DATE: 2021/05/06	TITLE: Rectangular Standard NFC Antenna Application Specification	SHEET No. 3 of 22
DOCUMENT NUMBER: AS-1462360001	CREATED / REVISED BY: Liu Hai 2021/03/17	CHECKED BY: Cheng Kang 2021/03/17	APPROVED BY: Andy Zhang 2021/03/17



APPLICATION SPECIFICATION

3.0 APPLICABLE DOCUMENTS

DOCUMENT	NUMBER	DESCRIPTION
Sale Drawing (SD)	SD-1462360001	Rectangle standard NFC
	SD-1462362131	NFC coil with AWG28 wire and connector
Product Specification (PS)	PS-1462360001	Antenna Product Specification
Packing Drawing (PK)	PK-1462360001	Product packaging specifications
	PK-1462362131	

<u>REVISION:</u> B2	<u>ECR/ECN INFORMATION:</u> EC No: 663046 DATE: 2021/05/06	<u>TITLE:</u> Rectangular Standard NFC Antenna Application Specification	<u>SHEET No.</u> 4 of 22
<u>DOCUMENT NUMBER:</u> AS-1462360001	<u>CREATED / REVISED BY:</u> Liu Hai 2021/03/17	<u>CHECKED BY:</u> Cheng Kang 2021/03/17	<u>APPROVED BY:</u> Andy Zhang 2021/03/17

4.0 ANTENNA PERFORMANCE

4.1 RF TEST CONDITIONS

All measurements are done of the antenna with VNA Agilent E5071C and LCR analyzer 5328.

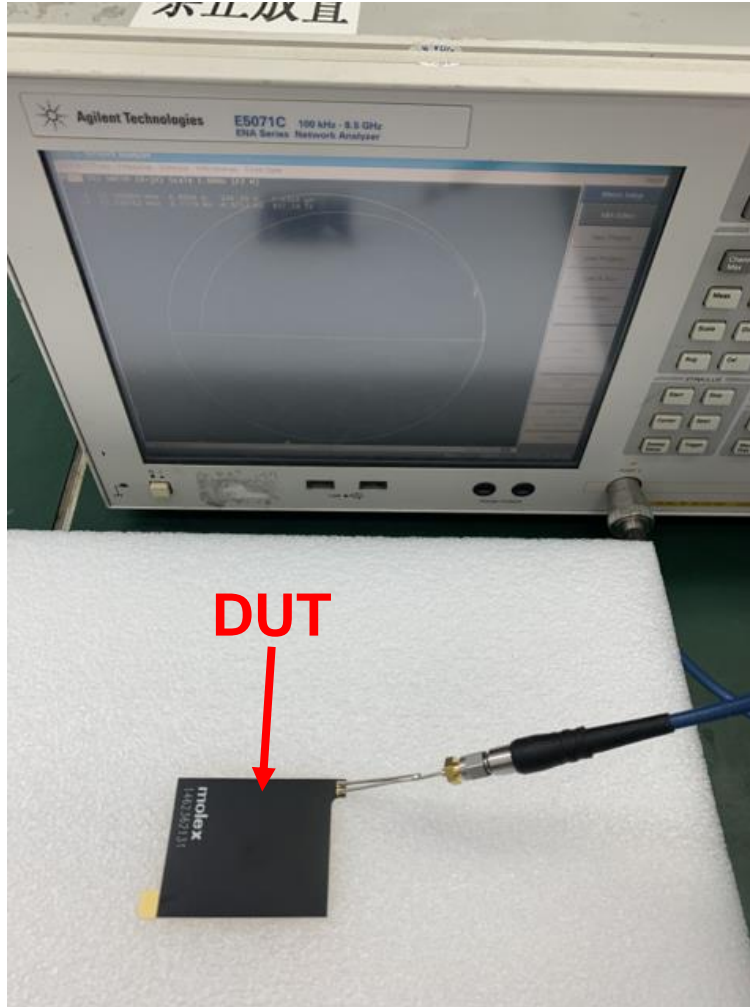

FIGURE4.1 ANTENNA TESTED WITH VNA E5071C

REVISION: B2	ECR/ECN INFORMATION: EC No: 663046 DATE: 2021/05/06	TITLE: Rectangular Standard NFC Antenna Application Specification	SHEET No. 5 of 22
DOCUMENT NUMBER: AS-1462360001	CREATED / REVISED BY: Liu Hai 2021/03/17	CHECKED BY: Cheng Kang 2021/03/17	APPROVED BY: Andy Zhang 2021/03/17

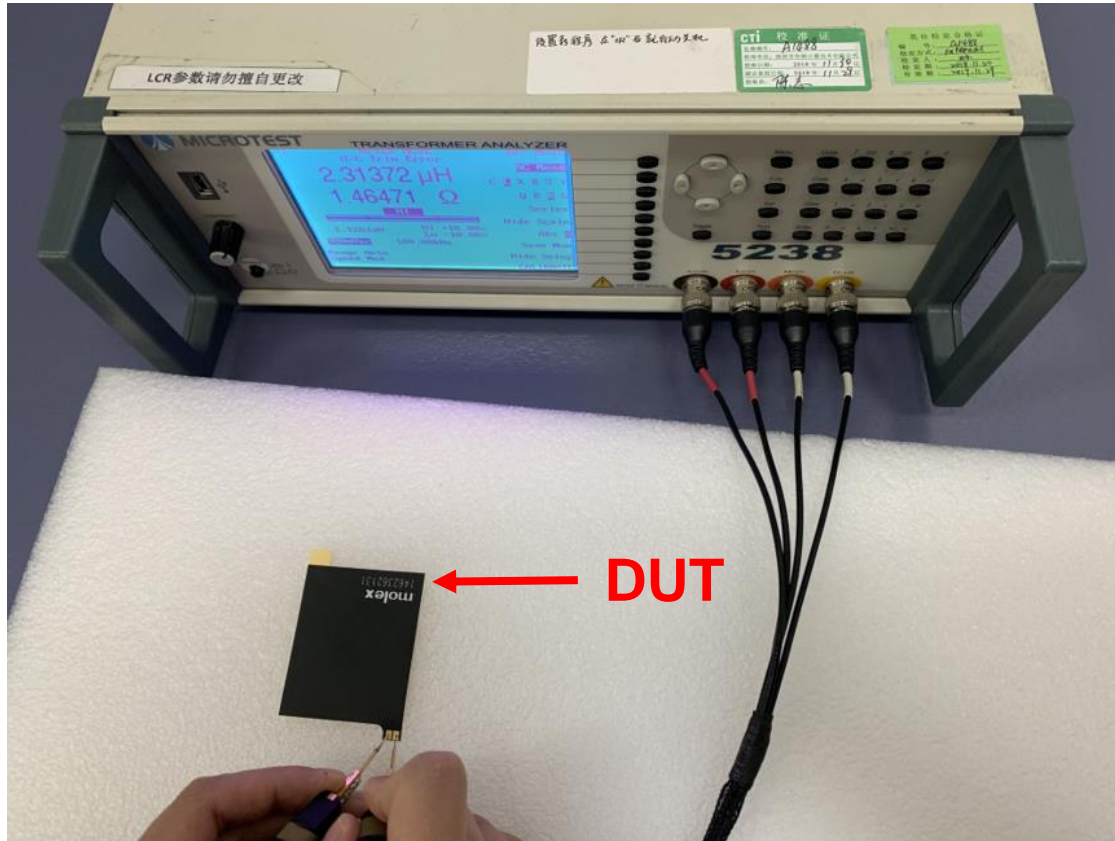

FIGURE 4.2 DCR TEST FOR NFC ANTENNA WITH LCR ANALYZER 5238

4.2 SPECIFICATIONS OF THE RECTANGULAR STANDARD NFC ANTENNA

Part No.	1462360001	1462360011	1462360021	1462360031	1462360051
Antenna Type	Near-field coupling				
Operating Frequency	13.56MHz				
La	2.0uH	2.0uH	2.6uH	2.4uH	1.4uH
Ra	3.4Ω	3.4Ω	3.2Ω	3.1Ω	2.3Ω
Ca	1.1pF	1.4 pF	2.3 pF	2.7 pF	0.9 pF
Fra	108.0MHz	96.9MHz	66.6MHz	62.7MHz	143.2MHz
Rp	41.5kΩ	28.0kΩ	18.9kΩ	14.8kΩ	50.0kΩ
Q	50.4	50.9	68.4	66.8	51.1

REVISION: B2	ECR/ECN INFORMATION: EC No: 663046 DATE: 2021/05/06	TITLE: Rectangular Standard NFC Antenna Application Specification	SHEET No. 6 of 22
DOCUMENT NUMBER: AS-1462360001	CREATED / REVISED BY: Liu Hai 2021/03/17	CHECKED BY: Cheng Kang 2021/03/17	APPROVED BY: Andy Zhang 2021/03/17

Part No.	1462360101	1462360111	1462360121	1462360131	1462360151
Material	With Ferrite				
Antenna Type	Near-field coupling				
Operating Frequency	13.56MHz				
La	3.1uH	3.0uH	3.8uH	3.5uH	2.1uH
Ra	5.1Ω	5.2Ω	6.2Ω	5.7Ω	3.6Ω
Ca	1.3 pF	1.8 pF	3.0 pF	3.7 pF	1.0 pF
Fra.	80.1MHz	70.7MHz	48.7MHz	45.8MHz	109.0MHz
Rp	12.7kΩ	12.4kΩ	10.3kΩ	10.8kΩ	10.0kΩ
Q	51.8	48.5	52.4	52.5	50.4

Part No.	1462362102	1462362111	1462362122	1462362131	1462362151
Material	With Ferrite and twisted pair				
Antenna Type	Near-field coupling				
Operating Frequency	13.56MHz				
La	3.3uH	3.3uH	4.2uH	4.1uH	2.4uH
Ra	6.0Ω	5.3Ω	7.8Ω	7.8Ω	5.1Ω
Ca	4.9 pF	5.3 pF	6.0 pF	7.9 pF	5.2 pF
Fra	41.8MHz	40.2MHz	34.3MHz	31.0MHz	46.8MHz
Rp	11.8kΩ	10.9kΩ	11.8kΩ	10.4kΩ	8.8kΩ
Q	46.8	53.5	46.0	44.2	40.6

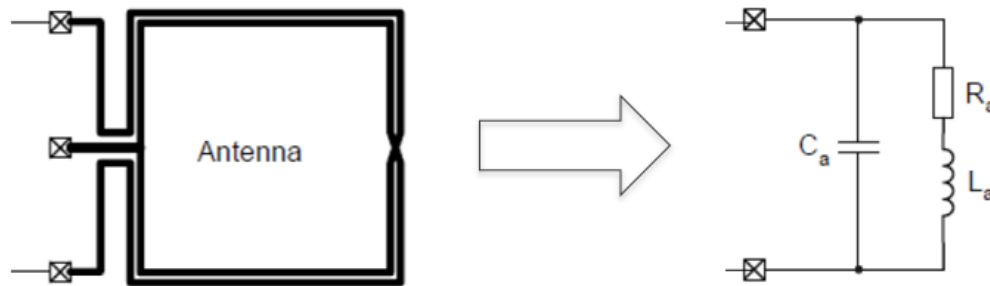

FIGURE4.2 ANTENNA EQUIVALENT CIRCUIT

Fra: Self-resonance frequency of the antenna
 Rp: Parallel resistance @ self-resonance frequency
 Q: Quality factor

REVISION:	ECR/ECN INFORMATION:	TITLE:	SHEET No.
B2	EC No: 663046 DATE: 2021/05/06	Rectangular Standard NFC Antenna Application Specification	7 of 22
DOCUMENT NUMBER:	CREATED / REVISED BY:	CHECKED BY:	APPROVED BY:
AS-1462360001	Liu Hai 2021/03/17	Cheng Kang 2021/03/17	Andy Zhang 2021/03/17

5.0 MATCHING NETWORK DESCRIPTION

The matching network will depend on the selected NFC antenna and the NFC chipset. When customers use the NFC antenna, they should change the matching network according to the actual application environment. During the detection distance test, in order to get good detection distance, the NFC antennas have been well matched on the evaluation board with various capacitor's value. The below picture shows the matching network for the evaluation board while the below table shows the reference capacitor values for each NFC antenna.

Note that the following matching is recommended for the TI evaluation board (model: TRF7970AEVM). When implement into the system, the frequency resonant might be off-tune due to the loading of surrounding components especially metal plane. This off-tune can be compensated through matching. And when different chipset is used in the real system, the matching circuit should be changed to match the chipset requirement.

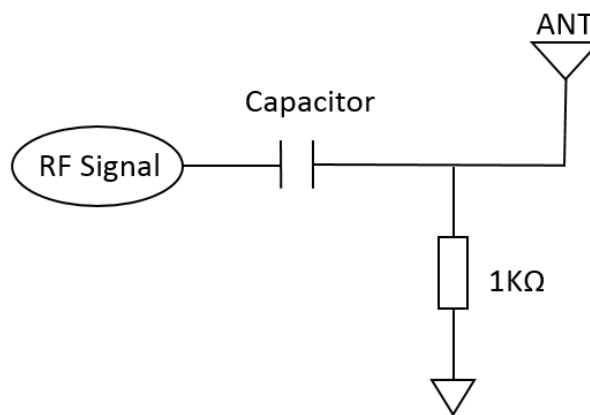

FIGURE 5.1 MATCHING NETWORK ON THE EVALUATION BOARD

REVISION: B2	ECR/ECN INFORMATION: EC No: 663046 DATE: 2021/05/06	TITLE: Rectangular Standard NFC Antenna Application Specification	SHEET No. 8 of 22
DOCUMENT NUMBER: AS-1462360001	CREATED / REVISED BY: Liu Hai 2021/03/17	CHECKED BY: Cheng Kang 2021/03/17	APPROVED BY: Andy Zhang 2021/03/17

	1462360001	1462360011	1462360021	1462360031	1462360051
Capacitor Values	68pF	68pF	56pF	56pF	100pF
	1462360101	1462360111	1462360121	1462360131	1462360151
Capacitor Values	51pF	51pF	39pF	47pF	68pF
	1462362102	1462362111	1462362122	1462362131	1462362151
Capacitor Values	51pF	51pF	39pF	47pF	68pF

FIGURE 5.2 CAPACITOR VALUES FOR NFC ANTENNA MATCHING NETWORK

6.0 DETECTION DISTANCE TEST

6.1 TEST SYSTEM FOR NFC ANTENNA IN FREE SPACE

To compare the NFC antenna performance, we design a test system to simulate the usage of the NFC antenna and measure the maximum detection distance. One thing should be mentioned here, this test system is different from the NFC forum protocol test system and it is just used for NFC antennas performance comparison.

The below picture shows the test system set up. The NFC antenna is connected to the evaluation board, which is controlled by the computer. In order to get good detection distance, the NFC antennas have been well matched on the evaluation board. The standard RFID tags are placed on plastic part of the fixture, which can be movable. With the help of the ruler, we can get the maximum detection distance between RFID tags and NFC antennas when the distance is tune and the reader cannot read the RFID tag.

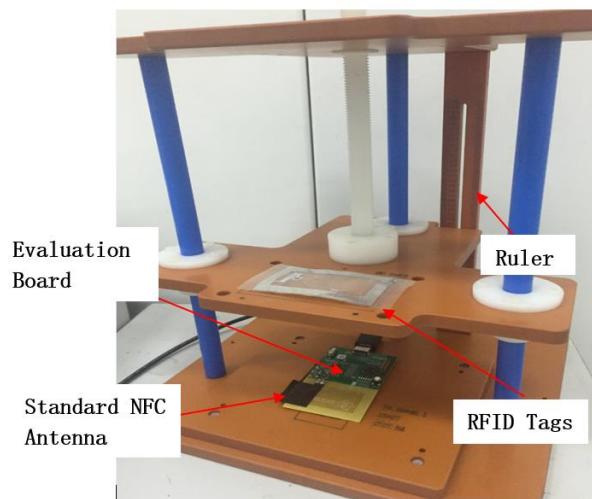

FIGURE 6.1.1 TEST SYSTEM FOR NFC ANTENNA IN FREE SPACE

REVISION: B2	ECR/ECN INFORMATION: EC No: 663046 DATE: 2021/05/06	TITLE: Rectangular Standard NFC Antenna Application Specification	SHEET No. 9 of 22
DOCUMENT NUMBER: AS-1462360001	CREATED / REVISED BY: Liu Hai 2021/03/17	CHECKED BY: Cheng Kang 2021/03/17	APPROVED BY: Andy Zhang 2021/03/17

The evaluation board manufacturer is Texas Instruments (TI), model is TRF7970AEVM. The below picture shows the antenna connected to the evaluation board.

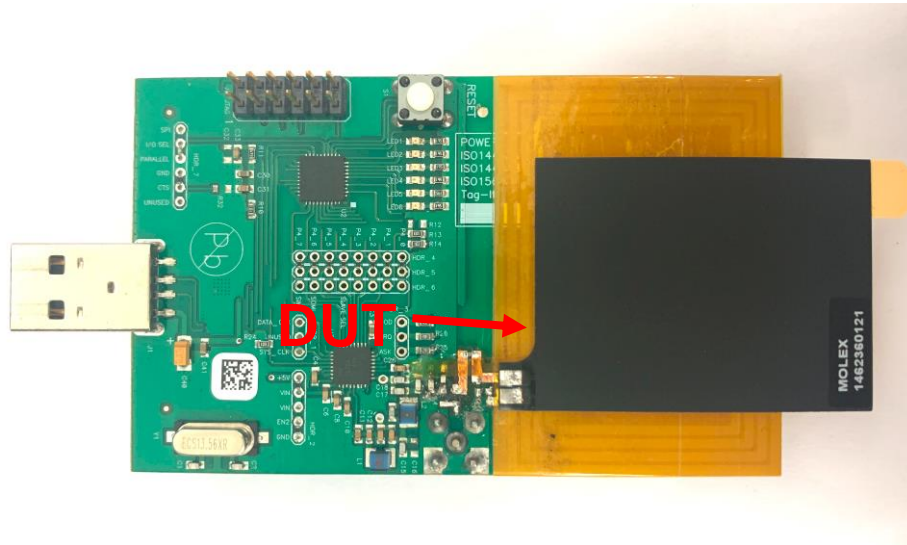

FIGURE 6.1.2 THE NFC ANTENNA IS CONNECTED TO THE EVALUATION BOARD

The Tag-it HF-I RFID tags from Texas Instruments tags used for measurement are as following: RI-102-112, RI-I03-112 and Button. The below pictures show the different tags.

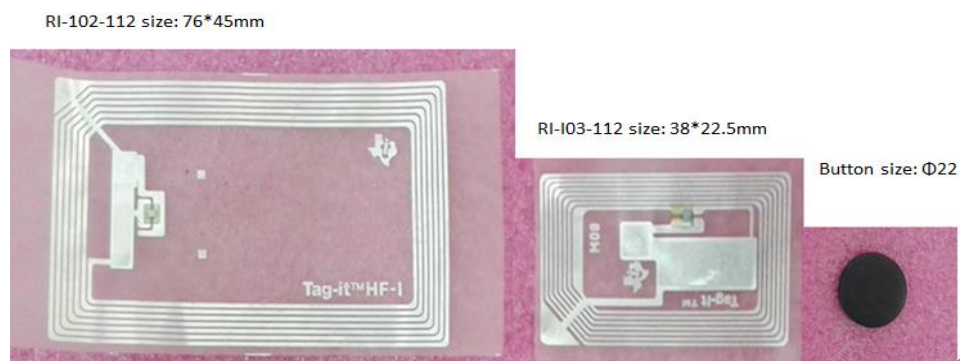

FIGURE 6.1.3 THE DIFFERENT RFID TAGS USED FOR MEASUREMENT

Texas Instruments Tag-it HF-I standard transponder inlays consist of 13.56-MHz high-frequency (HF) transponders that are compliant with the ISO/IEC 15693 and ISO/IEC 18000-3 global open standard. The Tag-it HF-I standard transponder inlays available in various inlay shapes also form the basis of consumable smart labels for use in markets requiring quick and accurate identification of items. The passive (no battery) transponder inlays are thin and flexible, offer a general purpose read/write capability, and are designed to be easily converted into paper or plastic labels.

The five sizes rectangular standard NFC antennas are under the detection distance test in free space. The below figures show the detection distance between NFC antennas and the three RFID tags.

REVISION: B2	ECR/ECN INFORMATION: EC No: 663046 DATE: 2021/05/06	TITLE: Rectangular Standard NFC Antenna Application Specification	SHEET No. 10 of 22
DOCUMENT NUMBER: AS-1462360001	CREATED / REVISED BY: Liu Hai 2021/03/17	CHECKED BY: Cheng Kang 2021/03/17	APPROVED BY: Andy Zhang 2021/03/17

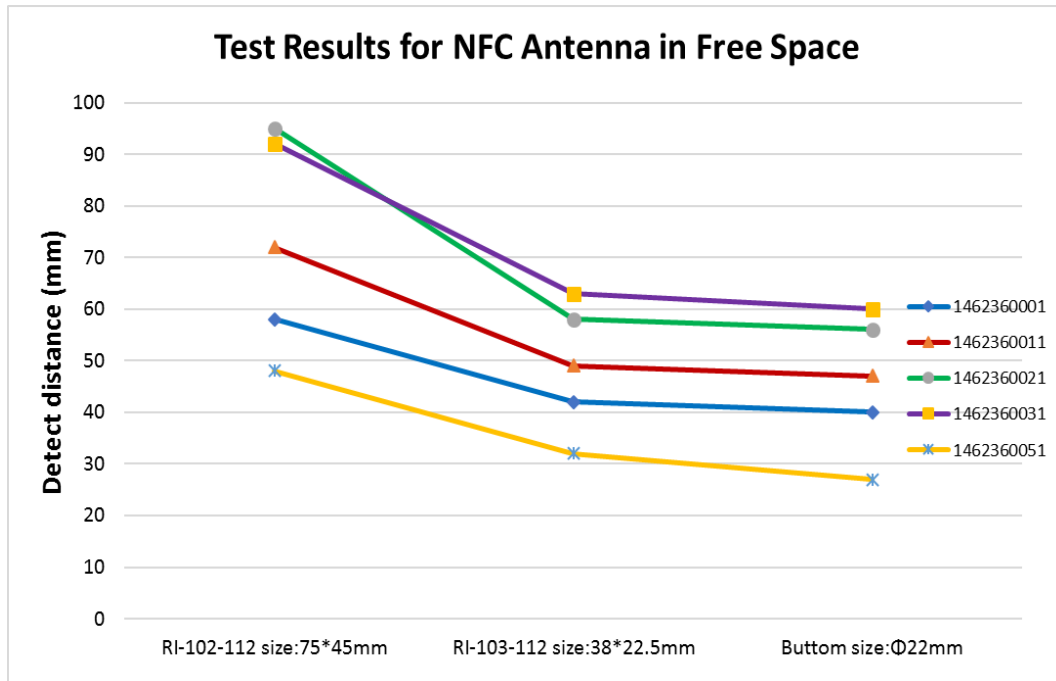

FIGURE 6.1.4 DETECTION DISTANCE FOR NFC ANTENNA IN FREE SPACE

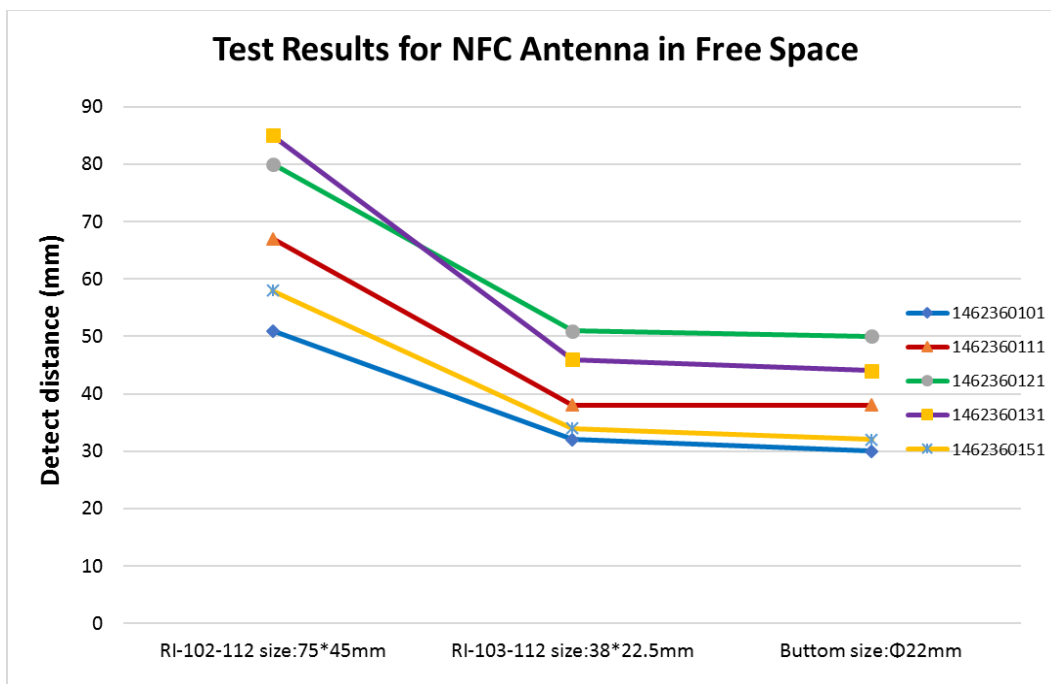

FIGURE 6.1.5 DETECTION DISTANCE FOR NFC ANTENNA WITH FERRITE IN FREE SPACE

REVISION: B2	ECR/ECN INFORMATION: EC No: 663046 DATE: 2021/05/06	TITLE: Rectangular Standard NFC Antenna Application Specification	SHEET No. 11 of 22
DOCUMENT NUMBER: AS-1462360001	CREATED / REVISED BY: Liu Hai 2021/03/17	CHECKED BY: Cheng Kang 2021/03/17	APPROVED BY: Andy Zhang 2021/03/17

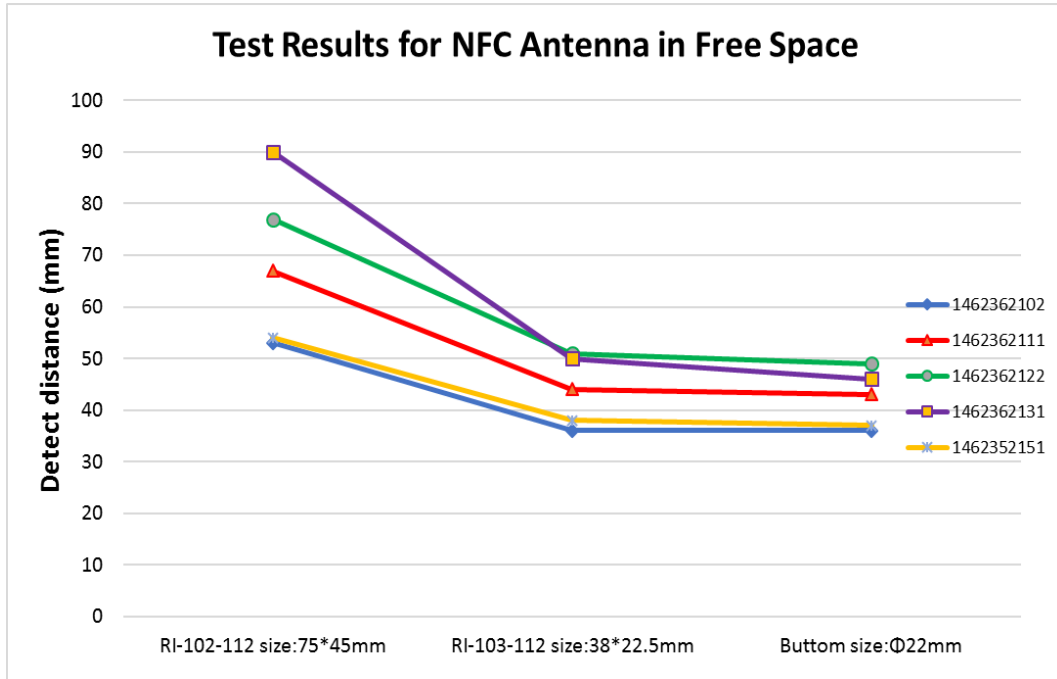

FIGURE 6.1.5 DETECTION DISTANCE FOR NFC ANTENNA WITH FERRITE AND TWISTED PAIR IN FREE SPACE

6.2 TEST SYSTEM FOR NFC ANTENNA ATTACHED NEAR METALLIC SURFACE

Compared with test results for NFC antenna in free space, the only difference is the metal part, which was simulated by a PCB with copper. We evaluate the influence of the distance between the metallic surface and NFC antenna.

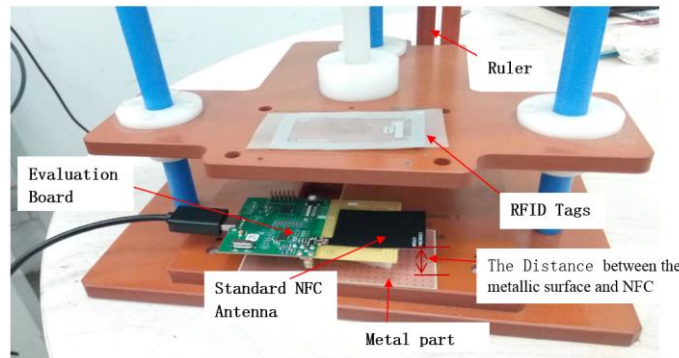

FIGURE 6.2 TEST SYSTEM FOR NFC ANTENNA ATTACHED NEAR METALLIC SURFACE

The five sizes rectangular standard NFC antennas as well as the antennas with Ferrite are under the detection distance test near metallic surface just as below.

REVISION: B2	ECR/ECN INFORMATION: EC No: 663046 DATE: 2021/05/06	TITLE: Rectangular Standard NFC Antenna Application Specification	SHEET No. 12 of 22
DOCUMENT NUMBER: AS-1462360001	CREATED / REVISED BY: Liu Hai 2021/03/17	CHECKED BY: Cheng Kang 2021/03/17	APPROVED BY: Andy Zhang 2021/03/17

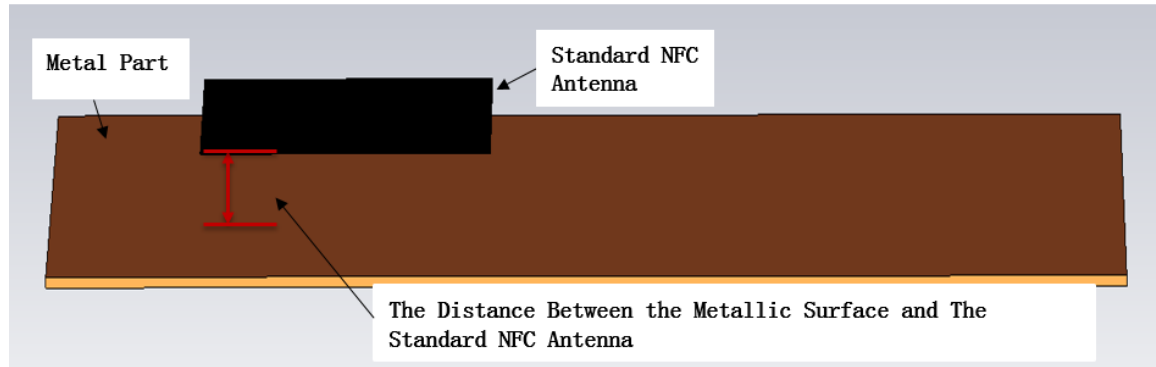

FIGURE 6.3 THE DISTANCE BETWEEN THE METALLIC SURFACE AND THE STANDARD NFC ANTENNA

The below figure 6.4 to figure 6.17 show the detection distance between NFC antennas and the three RFID tags in different distances between NFC antenna and metallic surface. The effect of metal is evaluated with 4 different distances from the standard NFC antenna. The 4 distances are as follow: 0mm, 5mm, 15mm and free space (without metal part).

From the Figure 6.4, Figure 6.6, Figure 6.8, Figure 6.10 and Figure 6.12 we can get that the NFC antennas without ferrite cannot work if they are mounted on the metallic surface directly. When the distance between NFC antenna and metallic surface is over 15mm, the detection distance between NFC antennas and RFID tags is close to the NFC antenna detection distance in free space.

From the Figure 6.14 to figure 6.17 we can get that the NFC antennas with ferrite and twisted pair can work if they are mounted on the metallic surface directly. When the distance between NFC antenna and metallic surface is over 15mm, the detection distance between NFC antennas and RFID tags is close to the NFC antenna with ferrite detection distance in free space.

From the Figure 6.4~Figure 6.17 we can get that the distance between NFC antenna and metallic surface is shorter than 15mm, the NFC antenna with ferrite performance is much better than the same size NFC antenna without ferrite. We recommend use the NFC antenna with ferrite in this situation. When the distance between NFC antenna and metallic surface is over than 15mm, the NFC antenna with ferrite is similar with the same size NFC antenna without ferrite. We recommend use the NFC antenna without ferrite in this situation.

REVISION: B2	ECR/ECN INFORMATION: EC No: 663046 DATE: 2021/05/06	TITLE: Rectangular Standard NFC Antenna Application Specification	SHEET No. 13 of 22
DOCUMENT NUMBER: AS-1462360001	CREATED / REVISED BY: Liu Hai 2021/03/17	CHECKED BY: Cheng Kang 2021/03/17	APPROVED BY: Andy Zhang 2021/03/17

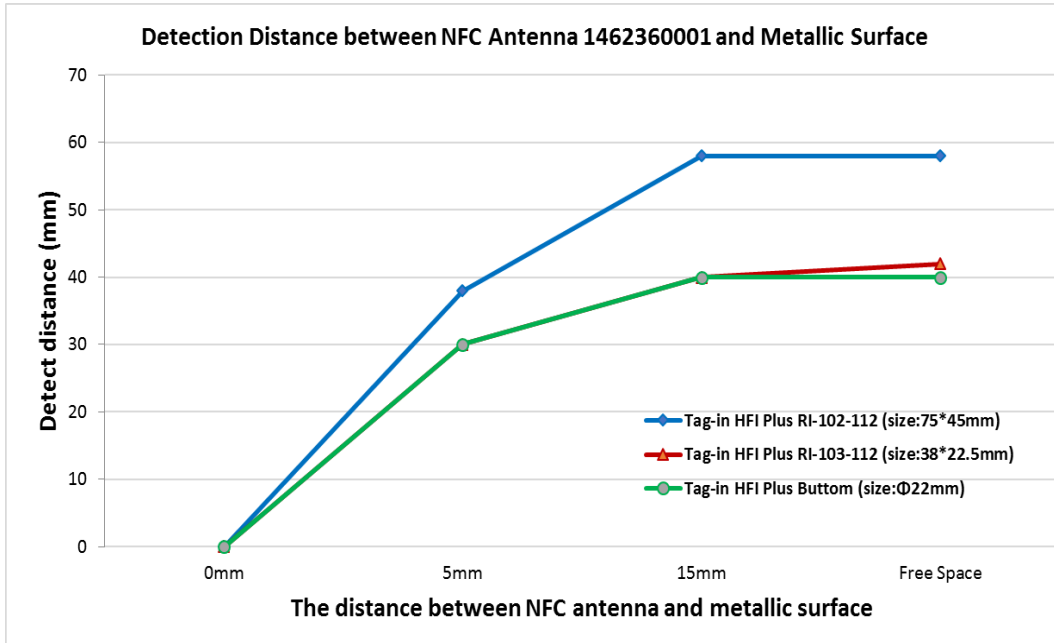

FIGURE 6.4 DETECTION DISTANCE FOR NFC ANTENNA 146236001(SIZE:15*25MM)

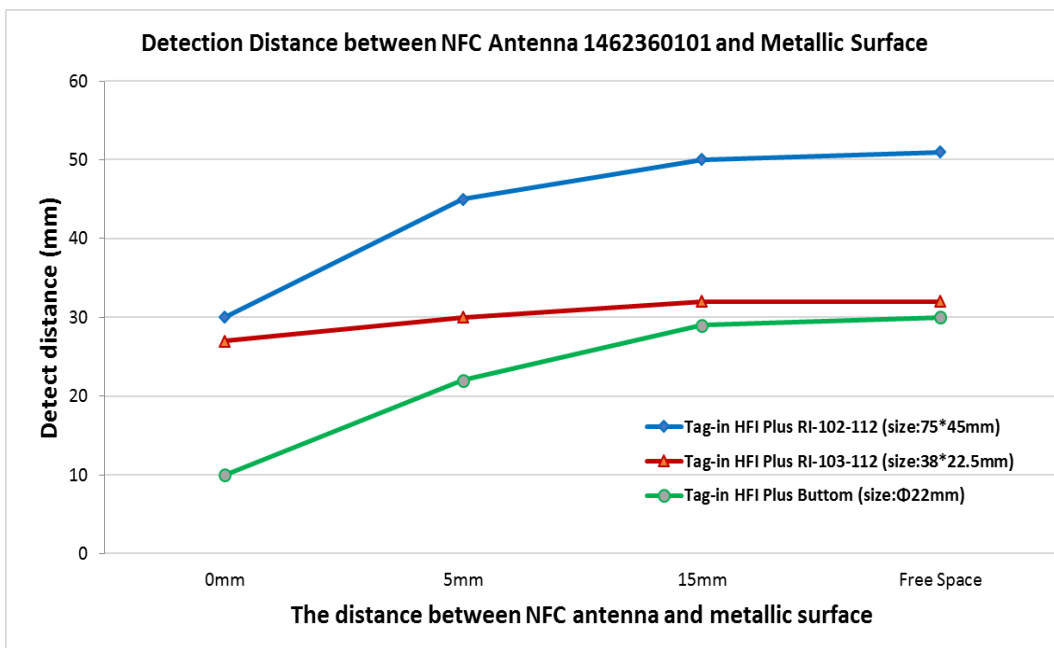

FIGURE 6.5 DETECTION DISTANCE FOR NFC ANTENNA 1462360101 WITH FERRITE (SIZE:15*25MM)

REVISION: B2	ECR/ECN INFORMATION: EC No: 663046 DATE: 2021/05/06	TITLE: Rectangular Standard NFC Antenna Application Specification	SHEET No. 14 of 22
DOCUMENT NUMBER: AS-1462360001	CREATED / REVISED BY: Liu Hai 2021/03/17	CHECKED BY: Cheng Kang 2021/03/17	APPROVED BY: Andy Zhang 2021/03/17

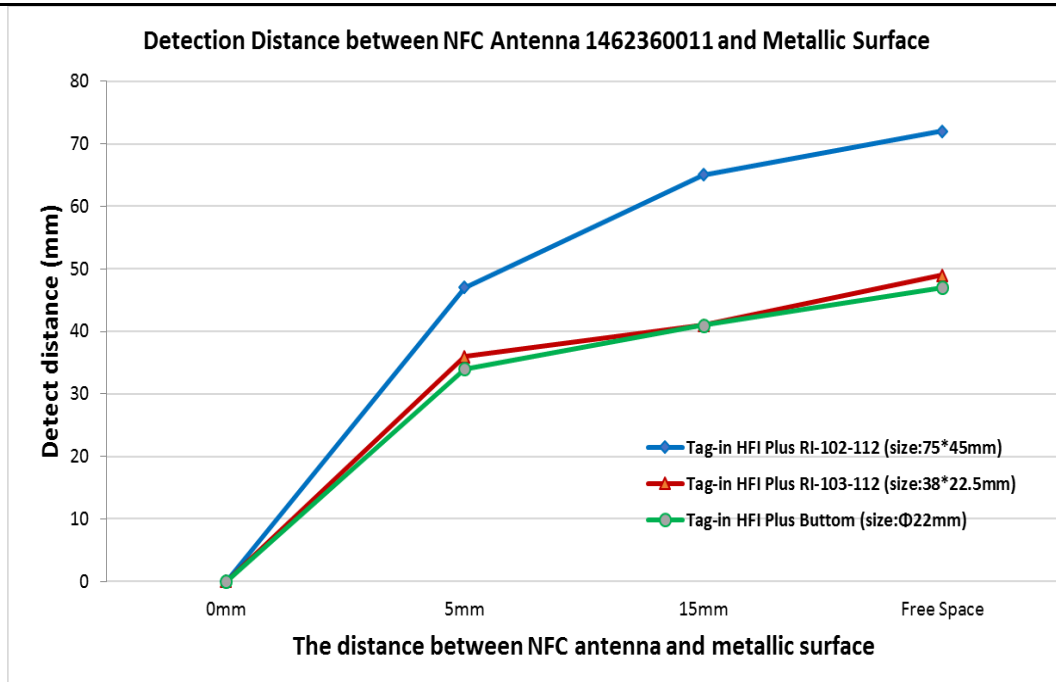

FIGURE 6.6 DETECTION DISTANCE FOR NFC ANTENNA 1462360011 (SIZE:23*27MM)

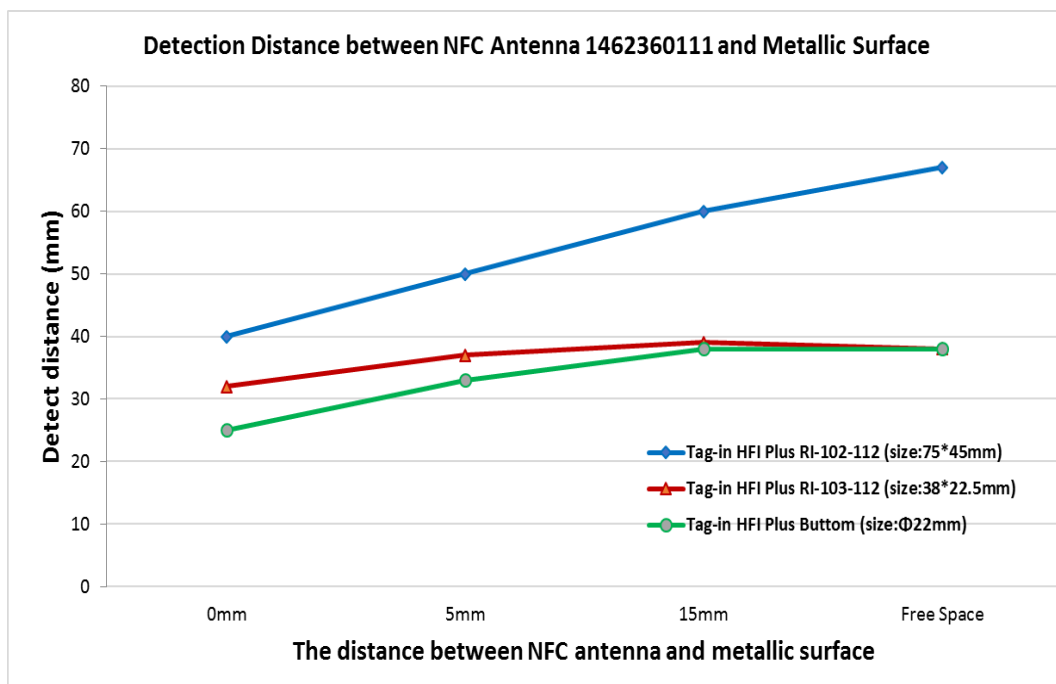

FIGURE 6.7 DETECTION DISTANCE FOR NFC ANTENNA 1462360111 WITH FERRITE (SIZE:23*27MM)

REVISION: B2	ECR/ECN INFORMATION: EC No: 663046 DATE: 2021/05/06	TITLE: Rectangular Standard NFC Antenna Application Specification	SHEET No. 15 of 22
DOCUMENT NUMBER: AS-1462360001	CREATED / REVISED BY: Liu Hai 2021/03/17	CHECKED BY: Cheng Kang 2021/03/17	APPROVED BY: Andy Zhang 2021/03/17

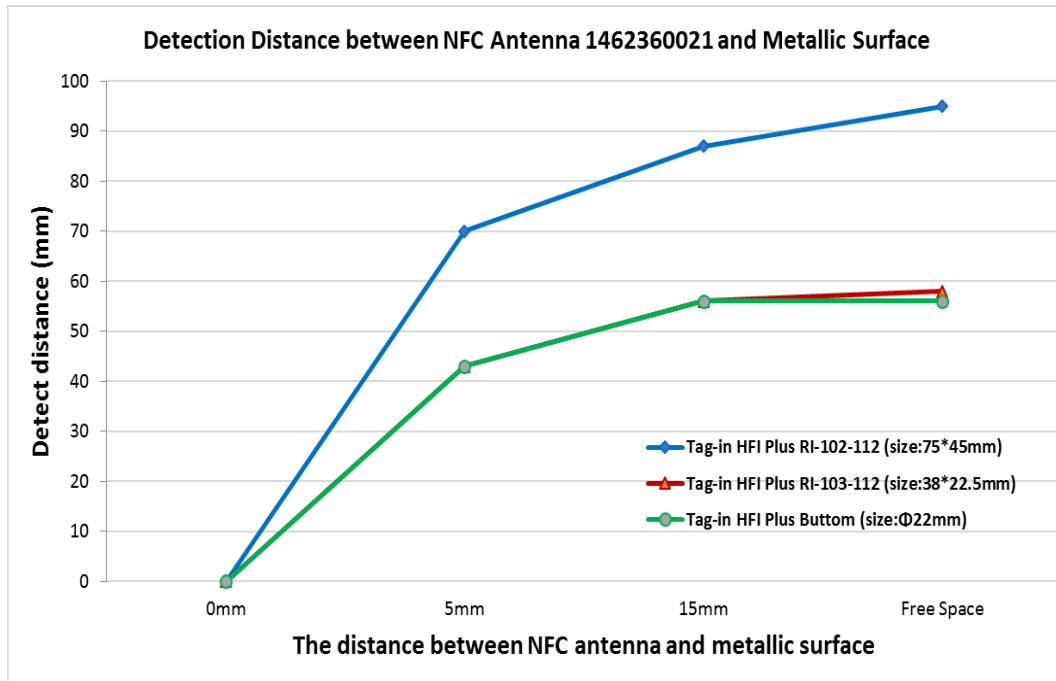

FIGURE 6.8 DETECTION DISTANCE FOR NFC ANTENNA 1462360021(SIZE:34*46MM)

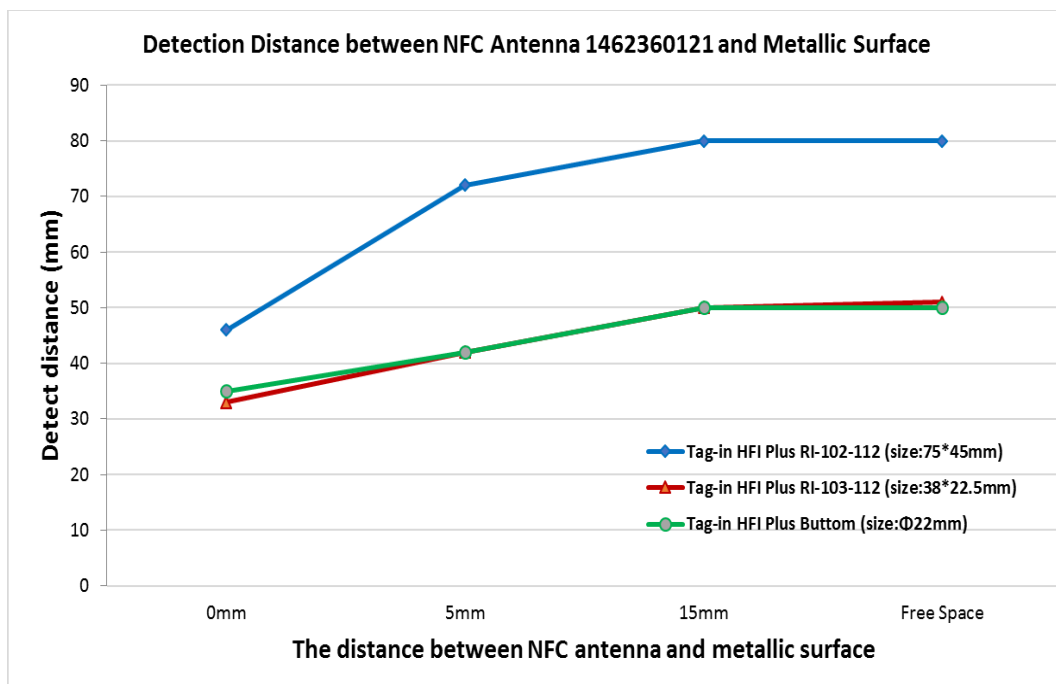

FIGURE 6.9 DETECTION DISTANCE FOR NFC ANTENNA 1462360121 WITH FERRITE (SIZE:34*46MM)

REVISION: B2	ECR/ECN INFORMATION: EC No: 663046 DATE: 2021/05/06	TITLE: Rectangular Standard NFC Antenna Application Specification	SHEET No. 16 of 22
DOCUMENT NUMBER: AS-1462360001	CREATED / REVISED BY: Liu Hai 2021/03/17	CHECKED BY: Cheng Kang 2021/03/17	APPROVED BY: Andy Zhang 2021/03/17

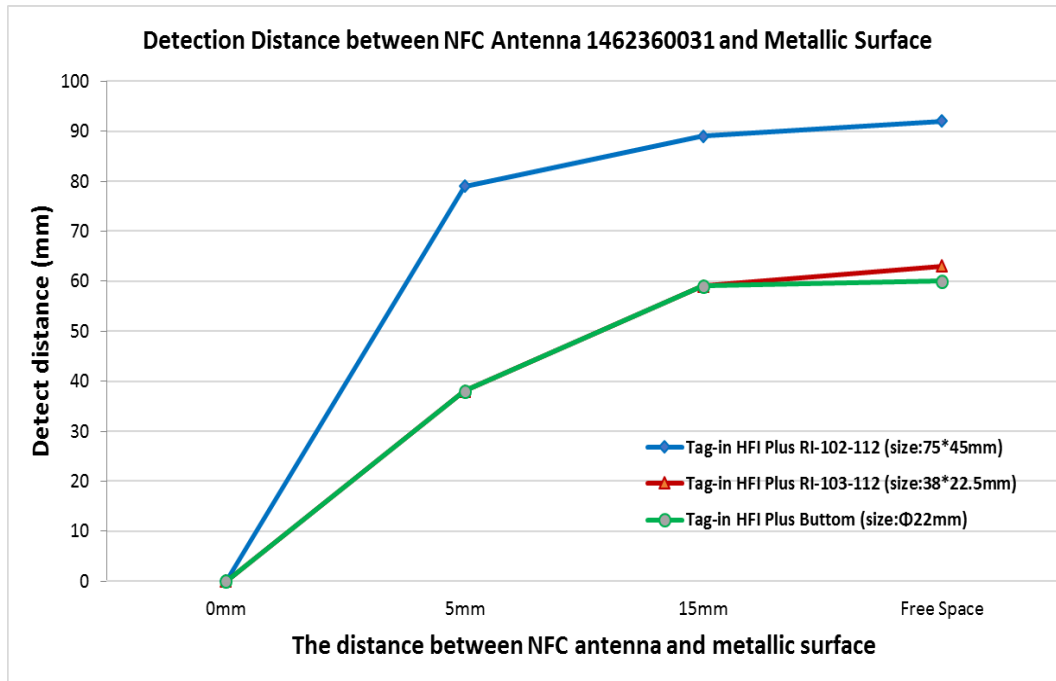

FIGURE 6.10 DETECTION DISTANCE FOR NFC ANTENNA 1462360031(SIZE:45*55MM)

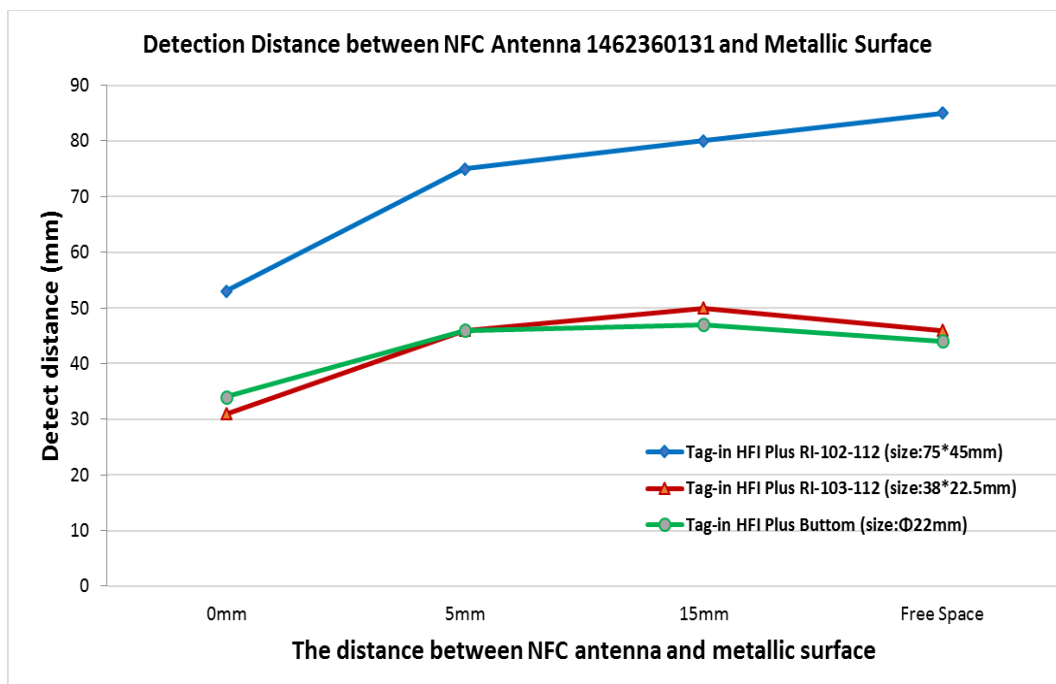

FIGURE 6.11 DETECTION DISTANCE FOR NFC ANTENNA 1462360131 WITH FERRITE (SIZE:45*55MM)

REVISION: B2	ECR/ECN INFORMATION: EC No: 663046 DATE: 2021/05/06	TITLE: Rectangular Standard NFC Antenna Application Specification	SHEET No. 17 of 22
DOCUMENT NUMBER: AS-1462360001	CREATED / REVISED BY: Liu Hai 2021/03/17	CHECKED BY: Cheng Kang 2021/03/17	APPROVED BY: Andy Zhang 2021/03/17

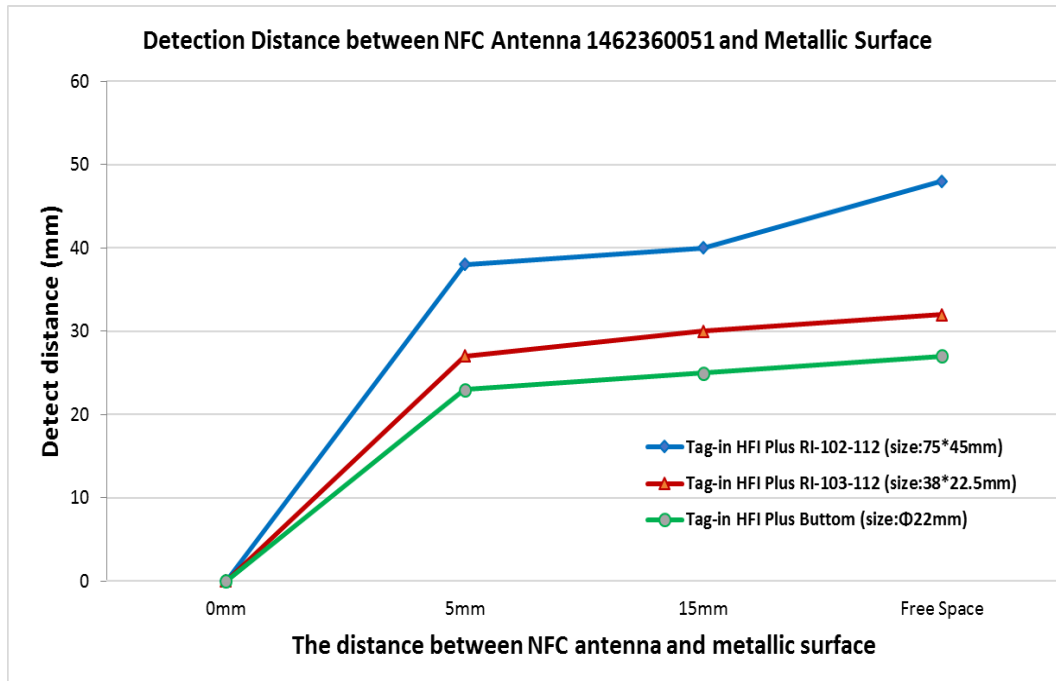

FIGURE 6.12 DETECTION DISTANCE FOR NFC ANTENNA 1462360051(SIZE:15*15MM)

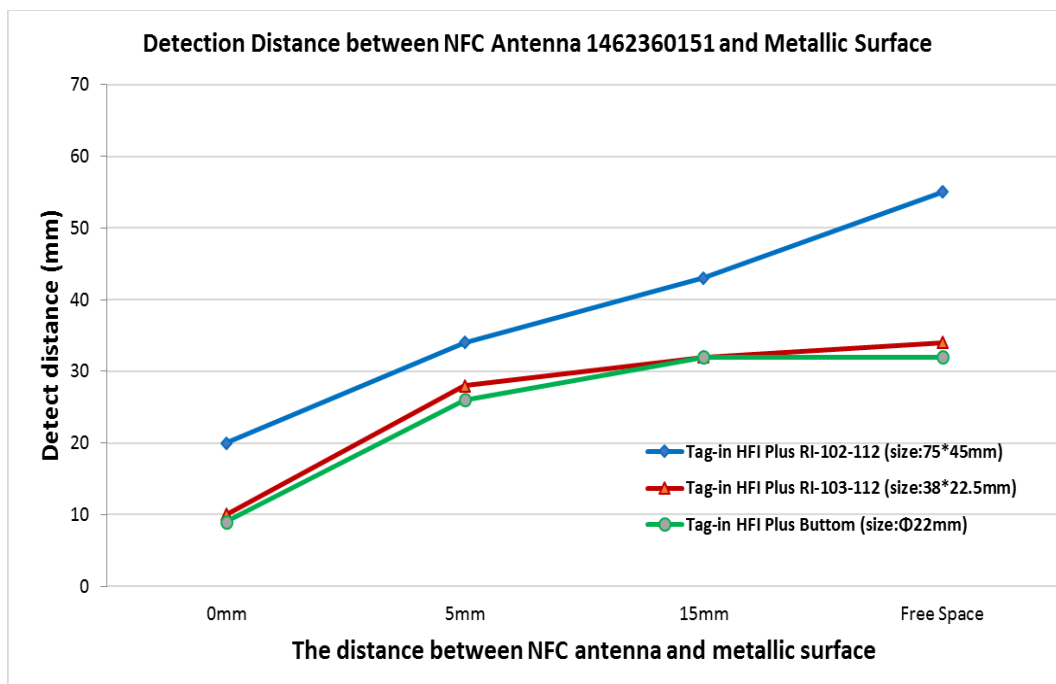

FIGURE 6.13 DETECTION DISTANCE FOR NFC ANTENNA 1462360151 WITH FERRITE (SIZE:15*15MM)

REVISION: B2	ECR/ECN INFORMATION: EC No: 663046 DATE: 2021/05/06	TITLE: Rectangular Standard NFC Antenna Application Specification	SHEET No. 18 of 22
DOCUMENT NUMBER: AS-1462360001	CREATED / REVISED BY: Liu Hai 2021/03/17	CHECKED BY: Cheng Kang 2021/03/17	APPROVED BY: Andy Zhang 2021/03/17

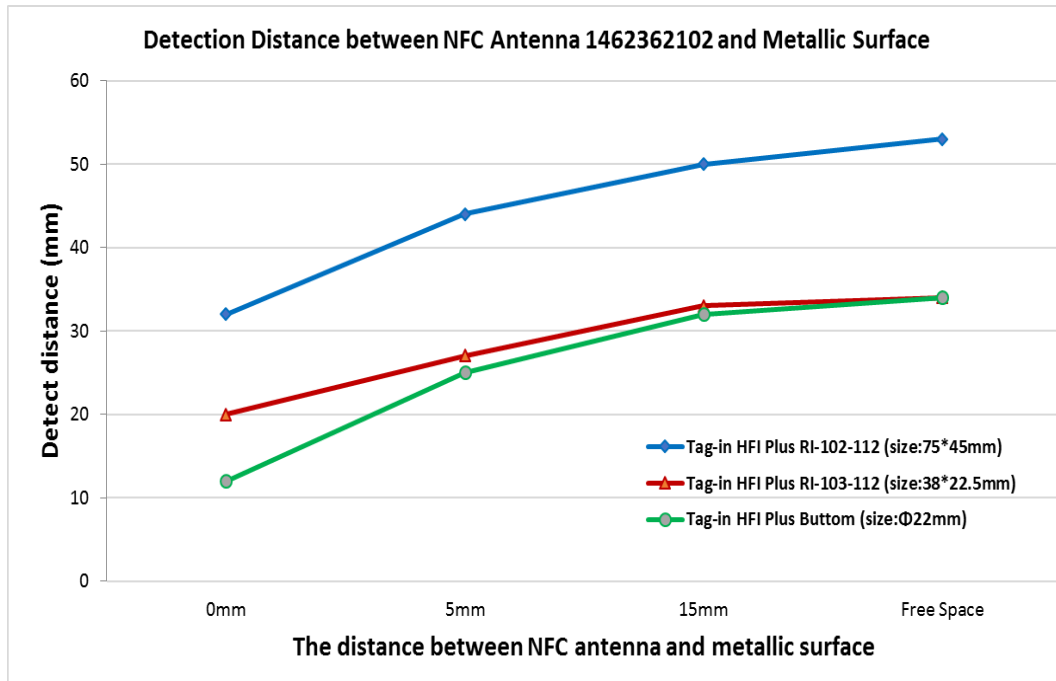

FIGURE 6.14 DETECTION DISTANCE FOR NFC ANTENNA 1462362102 WITH FERRITE AND TWISTED PAIR (SIZE: 15*25MM)

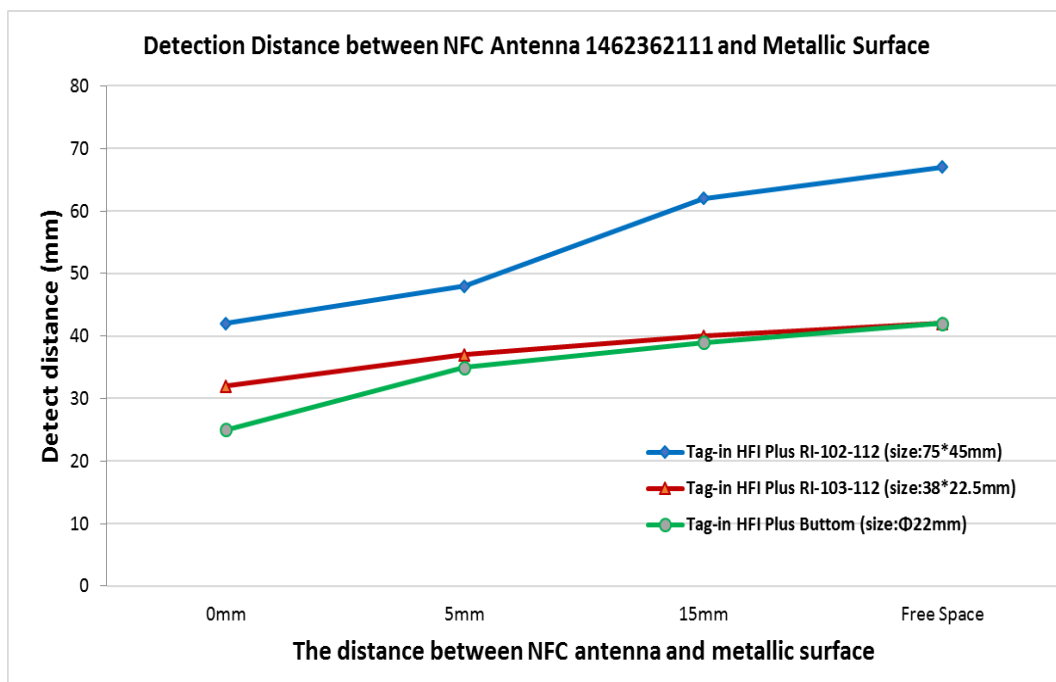

FIGURE 6.15 DETECTION DISTANCE FOR NFC ANTENNA 1462362111 WITH FERRITE AND TWISTED PAIR (SIZE: 23*27MM)

REVISION: B2	ECR/ECN INFORMATION: EC No: 663046 DATE: 2021/05/06	TITLE: Rectangular Standard NFC Antenna Application Specification	SHEET No. 19 of 22
DOCUMENT NUMBER: AS-1462360001	CREATED / REVISED BY: Liu Hai 2021/03/17	CHECKED BY: Cheng Kang 2021/03/17	APPROVED BY: Andy Zhang 2021/03/17

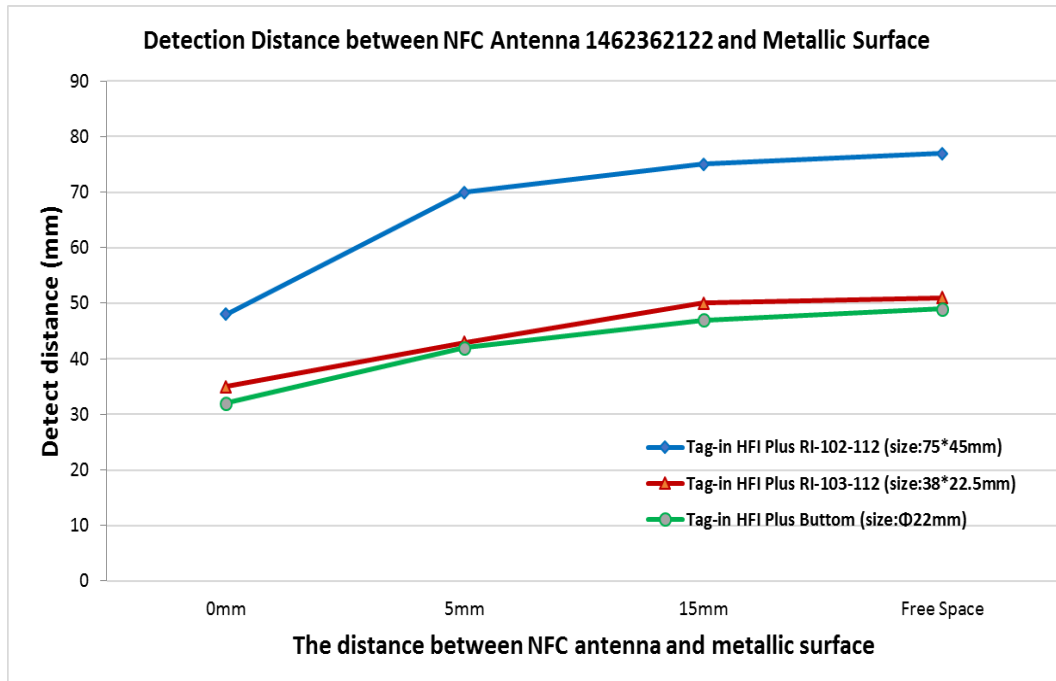

FIGURE 6.16 DETECTION DISTANCE FOR NFC ANTENNA 1462362122 WITH FERRITE AND TWISTED PAIR (SIZE:34*46MM)

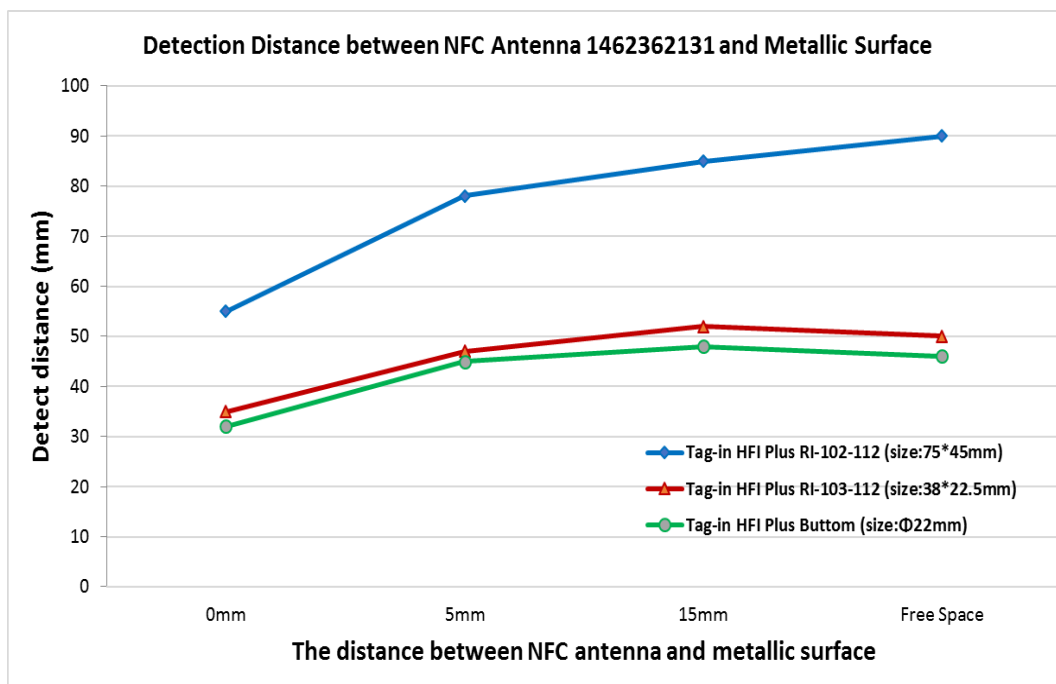

FIGURE 6.17 DETECTION DISTANCE FOR NFC ANTENNA 1462362131 WITH FERRITE AND TWISTED PAIR (SIZE:45*55MM)

REVISION: B2	ECR/ECN INFORMATION: EC No: 663046 DATE: 2021/05/06	TITLE: Rectangular Standard NFC Antenna Application Specification	SHEET No. 20 of 22
DOCUMENT NUMBER: AS-1462360001	CREATED / REVISED BY: Liu Hai 2021/03/17	CHECKED BY: Cheng Kang 2021/03/17	APPROVED BY: Andy Zhang 2021/03/17

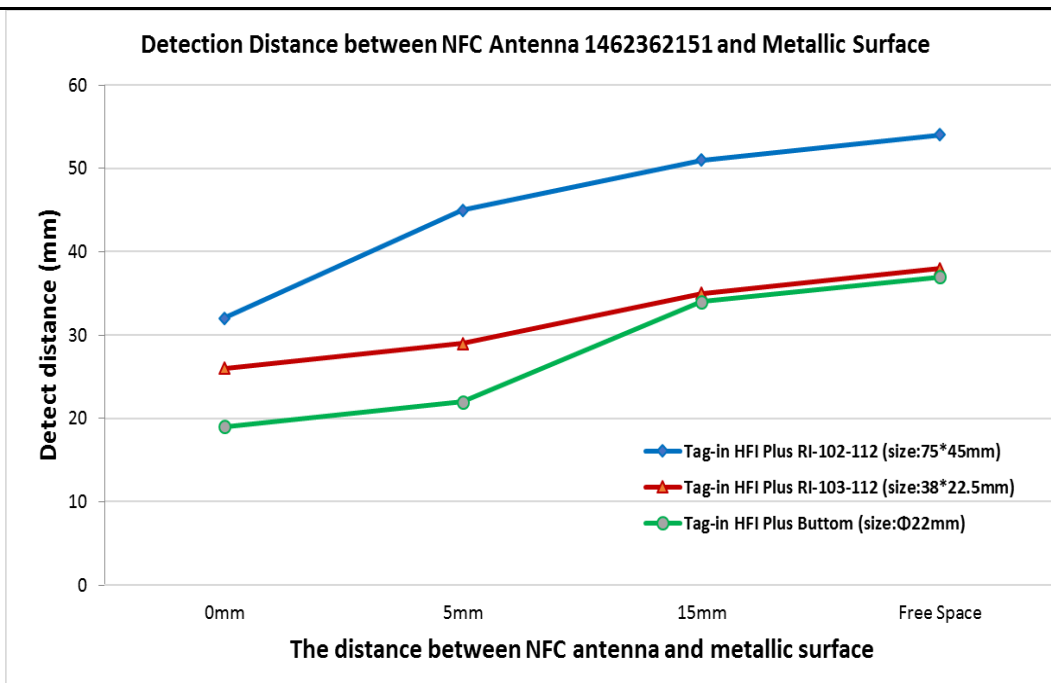

FIGURE 6.17 DETECTION DISTANCE FOR NFC ANTENNA 1462362151 WITH FERRITE AND TWISTED PAIR (SIZE:15*15MM)

REVISION: B2	ECR/ECN INFORMATION: EC No: 663046 DATE: 2021/05/06	TITLE: Rectangular Standard NFC Antenna Application Specification	SHEET No. 21 of 22
DOCUMENT NUMBER: AS-1462360001	CREATED / REVISED BY: Liu Hai 2021/03/17	CHECKED BY: Cheng Kang 2021/03/17	APPROVED BY: Andy Zhang 2021/03/17



APPLICATION SPECIFICATION

REV	DATE	DESCRIPTION
B2	2021/05/06	Updated 4.0 General Specification

REVISION: B2	ECR/ECN INFORMATION: EC No: 663046 DATE: 2021/05/06	TITLE: Rectangular Standard NFC Antenna Application Specification	SHEET No. 22 of 22
DOCUMENT NUMBER: AS-1462360001	CREATED / REVISED BY: Liu Hai 2021/03/17	CHECKED BY: Cheng Kang 2021/03/17	APPROVED BY: Andy Zhang 2021/03/17