



SparkFun Electronics
Artemis Module
Integration Guide
Version: 1p0p3

Table of Contents

Overview	3
Features	3
Mechanical Specifications	4
Pad Signals and Assignment	7
Designing Artemis Into End Application	10
Programming	10
Reflow Profile and Cleaning	14
Tape and Reel Packaging	14
Regulator Testing and Configuration	16
Regulatory Statements	16
Revision History	18

1. Overview

The SparkFun Artemis is a Cortex-M4F based BLE module using the Apollo3 microcontroller from Ambiq. The Artemis is capable of running machine learning algorithms with the low current consumption of 6 $\mu\text{A}/\text{MHz}$ at 3.3V. The Artemis has an integrated 2.4GHz antenna and incorporates all the necessary circuitry to implement a low power BLE enabled microcontroller.

2. Features

Ultra-low supply current

- 6 $\mu\text{A}/\text{MHz}$ executing from flash at 3.3V
- 1 μA deep sleep mode (BLE Off) with RTC at 3.3V
- Supply voltage: 1.75V to 3.63V with onboard DC/DC regulation

High-performance ARM Cortex-M4 Processor

- Up to 48 GPIO
- 48 MHz nominal clock frequency, with 96 MHz burst mode
- Floating point unit
- Memory protection unit
- Wake-up interrupt controller with 32 interrupts
- Up to 1 MB of flash memory for code/data
- Up to 384 KB of low leakage RAM for code/data
- 16 kB 2-way Associative/Direct-Mapped Cache

Integrated Bluetooth 5 low-energy module

- RF sensitivity: -93 dBm (typical)
- TX: 3 mA @ 0 dBm, RX: 3 mA
- TX peak output power: 4.0 dBm (max)

Small Size

- 15.5 x 10.5mm including antenna

Easy Integration

- Large SMD pads and spacing allow for low cost 2-layer carrier board implementations
- Programming over pre-configured serial bootloader or JTAG

Ultra-low power ADC

- 14 bit ADC at up to 2.67 MS/s effective continuous, multi-slot sampling rate
- 15 selectable input channels
- Voltage Comparator

- Temperature sensor with +/-3°C accuracy

ISO7816 Secure 'Smart Card' interface

Flexible serial peripherals

- 1x 2/4/8-bit SPI master interface
- 6x I2C/SPI masters for peripheral communication
- I2C/SPI slave for host communications
- 2x UART modules with 32-location Tx and Rx FIFOs
- PDM for mono and stereo audio microphone
- 1x I2S slave for PDM audio pass-through

Rich set of clock sources

- 32.768 kHz XTAL oscillator
- Low frequency RC oscillator – 1.024 kHz
- High frequency RC oscillator – 48/96 MHz
- RTC based on Ambiq's AM08X5/18X5 families

3. Mechanical Specifications

Module Dimensions	15.5 x 10.5 x 2.3mm
Weight	0.6g
Antenna	2.4 - 2.5GHz Chip

Recommended PCB Layout:

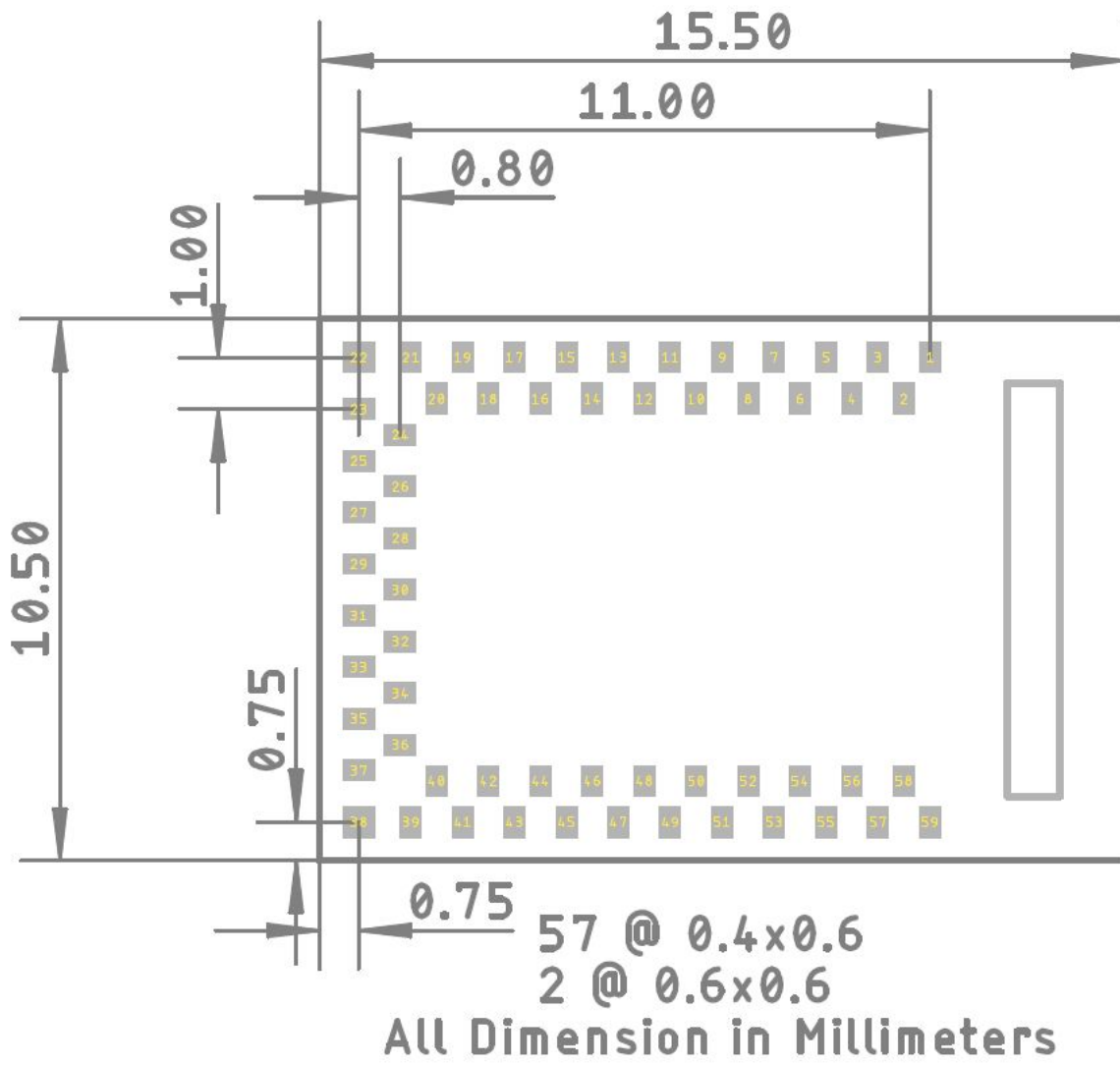

Top View
Copper Pad and Paste Aperture Dimensions

Recommended Soldermask Layout:

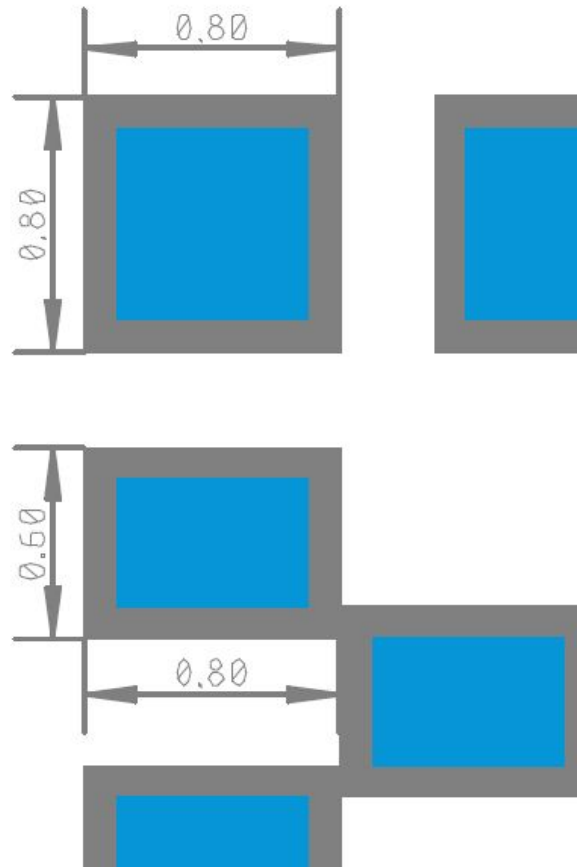

Solder Mask Dimensions

4. Pad Signals and Assignment

Module Pad No.	Name	Pin Function	Description
1	GND	Power	Ground
2	GPIO20	SWDCK	JTAG single wire clock
3	GPIO49	RX0 Bootload	RX pin for serial bootloading
4	GPIO39		
5	GPIO40		
6	GPIO9		
7	BOOT	Bootload	Hold pin high during reset to initiate bootloader
8	GPIO10		
9	GPIO48	TX0 Bootload	TX pin for serial bootloading
10	GPIO21	SWDIO	JTAG single wire I/O
11	GPIO8		
12	GPIO5		
13	GPIO7		
14	GPIO35		All GPIOs have up to 8 possible functions ranging from I2C, SPI, PDM, SCC, UART, I2S, and clock sources. Please see the Apollo3 datasheet for a complete listing of capabilities.
15	GPIO4		
16	GPIO24		
17	GPIO22		
18	GPIO23		
19	GPIO27		
20	GPIO14		
21	GPIO28		
22	GND	Power	
23	GPIO6		
24	GPIO32		
25	GPIO25		
26	GPIO12		
27	GPIO26		
28	GPIO13		
29	GPIO15		
30	GPIO33		
31	GPIO34		
32	GPIO11		
33	GPIO29		

34	XO	32kHz Xtal	Connection for external 32.768kHz RTC crystal
35	XI	32kHz Xtal	Connection for external 32.768kHz RTC crystal
36	VDD	Power	
37	VDD	Power	
38	GND	Power	
39	GND	Power	
40	GPIO19		
41	GPIO18		
42	GPIO16		
43	GPIO17		
44	GPIO31		
45	GPIO41		
46	GPIO45		
47	GND	Power	
48	GPIO2		
49	GPIO1		
50	nRESET	System Reset	Pull pin low to reset system
51	GPIO0		
52	GPIO43		
53	GPIO42		
54	GPIO3		
55	GPIO36		
56	GPIO38		
57	GPIO37		
58	GPIO44		
59	GND	Power	

Pad	PADnFNCSEL							
	0	1	2	3	4	5	6	7
0	SLSCL	SLSCK	CLKOUT	GPIO00		MSPI4		NCE0
1	SLSDAWIR3	SLMOSI	UART0TX	GPIO01		MSPI5		NCE1
2	UART1RX	SLMISO	UART0RX	GPIO02		MSPI6		NCE2
3	UA0RTS	SLnCE	NCE3	GPIO03		MSPI7	TRIG1	I2SWCLK
4	UA0CTS	SLINT	NCE4	GPIO04		UART1RX	CT17	MSPI2
5	M0SCL	M0SCK	UA0RTS	GPIO05		-		CT8
6	M0SDAWIR3	M0MISO	UA0CTS	GPIO06		CT10		I2SDAT
7	NCE7	M0MOSI	CLKOUT	GPIO07	TRIG0	UART0TX		CT19
8	M1SCL	M1SCK	NCE8	GPIO08	SCCCLK		UART1TX	
9	M1SDAWIR3	M1MISO	NCE9	GPIO09	SCCIO		UART1RX	
10	UART1TX	M1MOSI	NCE10	GPIO10	PDMCLK	UA1RTS		
11	ADCSE2	NCE11	CT31	GPIO11	SLINT	UA1CTS	UART0RX	PDMDATA
12	ADCD0NSE9	NCE12	CT0	GPIO12	SLnCE	PDMCLK	UA0CTS	UART1TX
13	ADCD0PSE8	NCE13	CT2	GPIO13	I2SBCLK	-	UA0RTS	UART1RX
14	ADCD1P	NCE14	UART1TX	GPIO14	PDMCLK	-	SWDCK	32KHzXT
15	ADCD1N	NCE15	UART1RX	GPIO15	PDMDATA	-	SWDIO	SWO
16	ADCSE0	NCE16	TRIG0	GPIO16	SCCRST	CMPIN0	UART0TX	UA1RTS
17	CMPRF1	NCE17	TRIG1	GPIO17	SCCCLK		UART0RX	UA1CTS
18	CMPIN1	NCE18	CT4	GPIO18	UA0RTS	-	UART1TX	SCCIO
19	CMPRF0	NCE19	CT6	GPIO19	SCCCLK	-	UART1RX	I2SBCLK
20	SWDCK	NCE20		GPIO20	UART0TX	UART1TX	I2SBCLK	UA1RTS
21	SWDIO	NCE21		GPIO21	UART0RX	UART1RX	SCCRST	UA1CTS
22	UART0TX	NCE22	CT12	GPIO22	PDMCLK	-	MSPI0	SWO
23	UART0RX	NCE23	CT14	GPIO23	I2SWCLK	CMPOUT	MSPI3	-
24	UART1TX	NCE24	MSPI8	GPIO24	UA0CTS	CT21	32KHzXT	SWO
25	UART1RX	NCE25	CT1	GPIO25	M2SDAWIR3	M2MISO		
26	-	NCE26	CT3	GPIO26	SCCRST	MSPI1	UART0TX	UA1CTS
27	UART0RX	NCE27	CT5	GPIO27	M2SCL	M2SCK		
28	I2SWCLK	NCE28	CT7	GPIO28		M2MOSI	UART0TX	
29	ADCSE1	NCE29	CT9	GPIO29	UA0CTS	UA1CTS	UART0RX	PDMDATA
30	-	NCE30	CT11	GPIO30	UART0TX	UA1RTS	BLEIF_SCK	I2SDAT
31	ADCSE3	NCE31	CT13	GPIO31	UART0RX	SCCCLK	BLEIF_MISO	UA1RTS
32	ADCSE4	NCE32	CT15	GPIO32	SCCIO	-	BLEIF_MOSI	UA1CTS
33	ADCSE5	NCE33	32KHzXT	GPIO33	BLEIF_CSN	UA0CTS	CT23	SWO
34	ADCSE6	NCE34	UA1RTS	GPIO34	CMPRF2	UA0RTS	UART0RX	PDMDATA
35	ADCSE7	NCE35	UART1TX	GPIO35	I2SDAT	CT27	UA0RTS	BLEIF_STATUS
36	TRIG1	NCE36	UART1RX	GPIO36	32KHzXT	UA1CTS	UA0CTS	PDMDATA
37	TRIG2	NCE37	UA0RTS	GPIO37	SCCIO	UART1TX	PDMCLK	CT29
38	TRIG3	NCE38	UA0CTS	GPIO38		M3MOSI	UART1RX	
39	UART0TX	UART1TX	CT25	GPIO39	M4SCL	M4SCK		
40	UART0RX	UART1RX	TRIG0	GPIO40	M4SDAWIR3	M4MISO		
41	NCE41	BLEIF_JRQ	SWO	GPIO41	I2SWCLK	UA1RTS	UART0TX	UA0RTS
42	UART1TX	NCE42	CT16	GPIO42	M3SCL	M3SCK		
43	UART1RX	NCE43	CT18	GPIO43	M3SDAWIR3	M3MISO		
44	UA1RTS	NCE44	CT20	GPIO44		M4MOSI	UART0TX	
45	UA1CTS	NCE45	CT22	GPIO45	I2SDAT	PDMDATA	UART0RX	SWO
46	I2SBCLK	NCE46	CT24	GPIO46	SCCRST	PDMCLK	UART1TX	SWO
47	32KHzXT	NCE47	CT26	GPIO47		M5MOSI	UART1RX	
48	UART0TX	NCE48	CT28	GPIO48	M5SCL	M5SCK		
49	UART0RX	NCE49	CT30	GPIO49	M5SDAWIR3	M5MISO		

Overview of Pad Functions

Note: Apollo Pad# maps to GPIO# on Artemis

5. Designing Artemis Into End Application

Routing and Recommended Keep Out

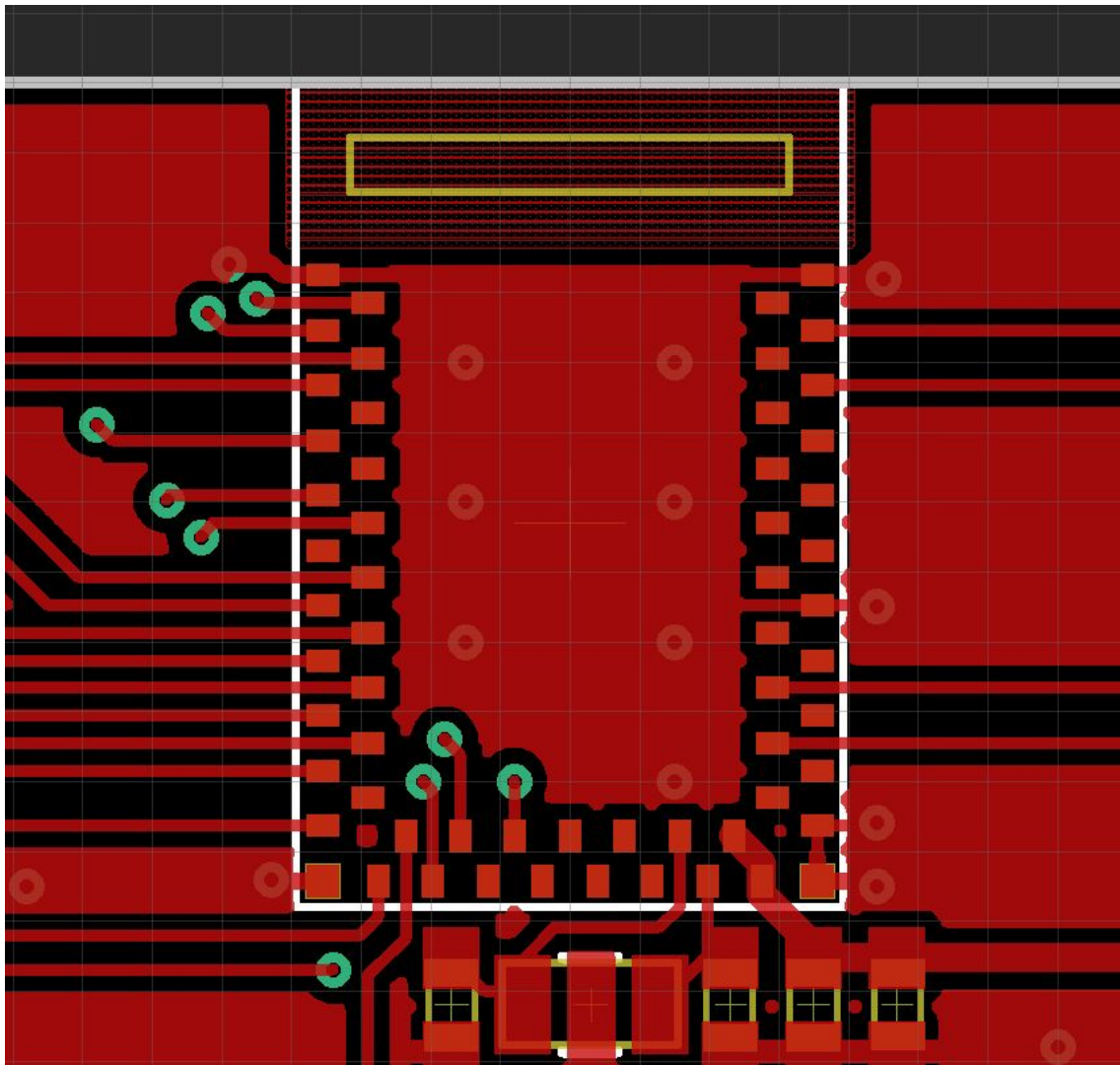

An example layout with ground pour and ground vias

The Artemis module was designed to be implemented onto low cost 2-layer PCBs with easy 8mil trace/space routing. A good ground connection is essential. Routing under the module is allowed. Keep all ground pours away from the antenna area. If mechanical exposure allows for it the antenna can be extended over the edge of the PCB for increased reception.

6. Programming

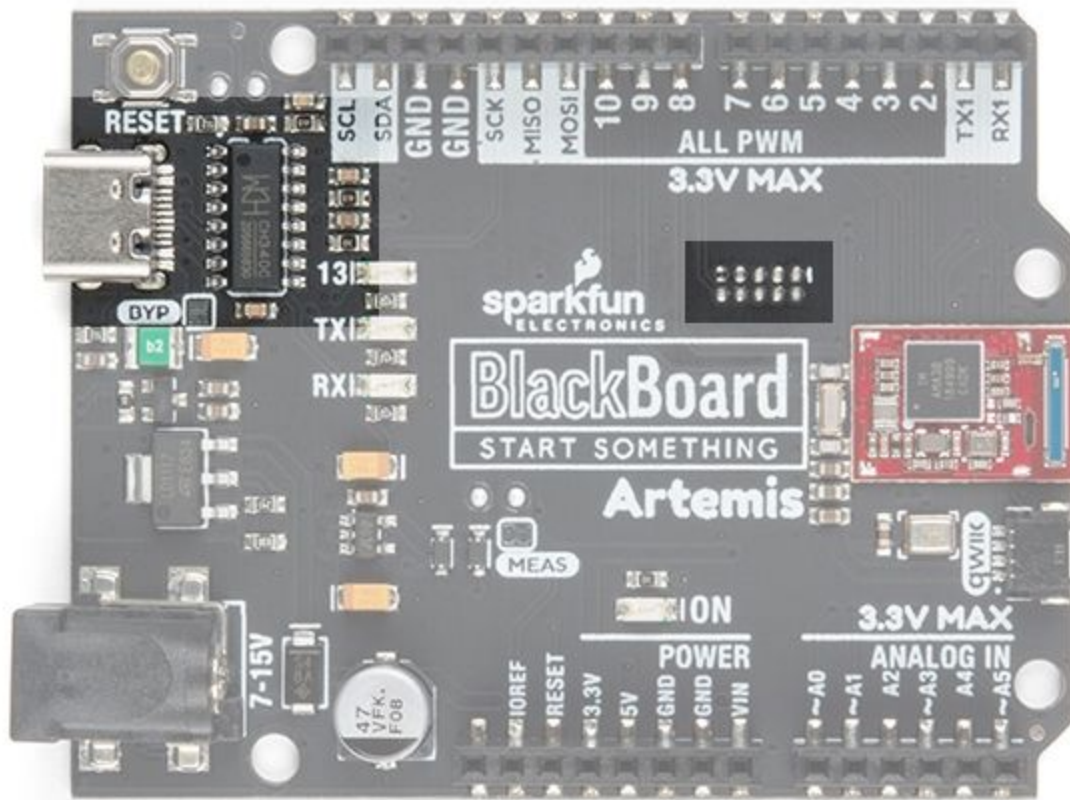

Two example programming interfaces

Artemis can be programmed using the standard JTAG interface or with a serial bootloader. The Artemis module can be routed to USB to serial circuit or an industry standard JTAG connector for more advanced programming and debugging. For more information on ARM programming, including JTAG interfaces, check out our [ARM Programming Tutorial](#).

SparkFun Bootloader

We've designed a baud rate flexible bootloader that is run at each power on reset. What does baud rate flexible mean exactly? The computer initiates communication at a given baud rate (921600bps for example) and the Artemis auto-detects the baud rate and transfers the bulk of the binary data at the agreed upon rate. This enables upload speeds up to 921600bps; significantly reducing upload times. A flexible rate allows computer systems that may have problems at higher rates to select the rate that works best. This bootloader is the preferred method for uploading sketches and user code that needs quick and reliable means of getting new code onto the Artemis.

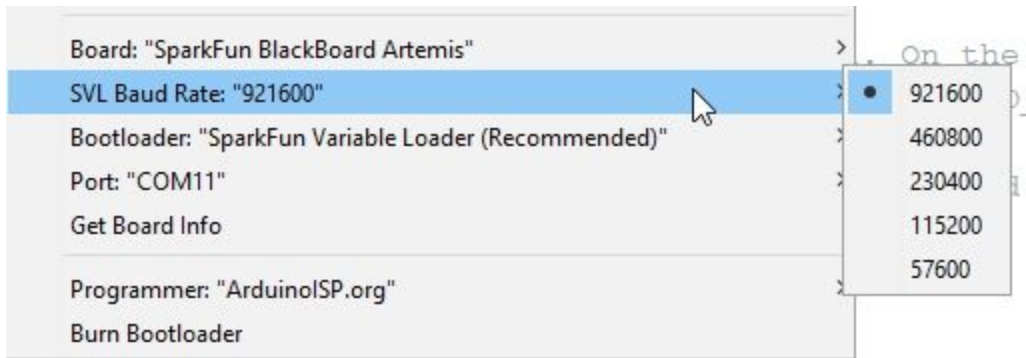

Once you've selected an Artemis target board additional menu options will appear the next time you open the Tools menu. The SVL Baud Rate options will allow you to change the upload speed. 921600bps is the recommended speed as it's extremely fast to update new sketches. However, there are some platforms (Linux flavors) where the standard CH340 USB to serial drivers don't operate well at speeds higher than 115200. So if you run into upload problems, consider reducing the upload speed. For more information about Linux upload issues see [this forum post](#) and consider upgrading with [these drivers](#).

Just like the classic Arduino Uno, Arduino Mega, etc, the bootloader is activated by resetting the board. A single 0.1uF capacitor between DTR and reset is all that is needed to cause the Artemis to reset and enter bootload mode. If no new firmware is detected within a short amount of time (50ms), user code is run.

If you're into niche electrical engineering discussions on things like bootloaders, you can read more about the Artemis bootloader [here](#).

Factory Bootloader

In addition to the SparkFun Artemis bootloader, we program every Artemis with the Ambiq factory Secure Bootloader (SBL). This bootloader is best used for low-level updates to devices that need to have a secure provenance. The bootloader is activated at reset if pin 47 is high and communicates at 115200. The bootloader will then wait indefinitely for new binary data. SparkFun provides a python tool as well as an executable to communicate with this bootloader.

Bootloader Reset Circuit

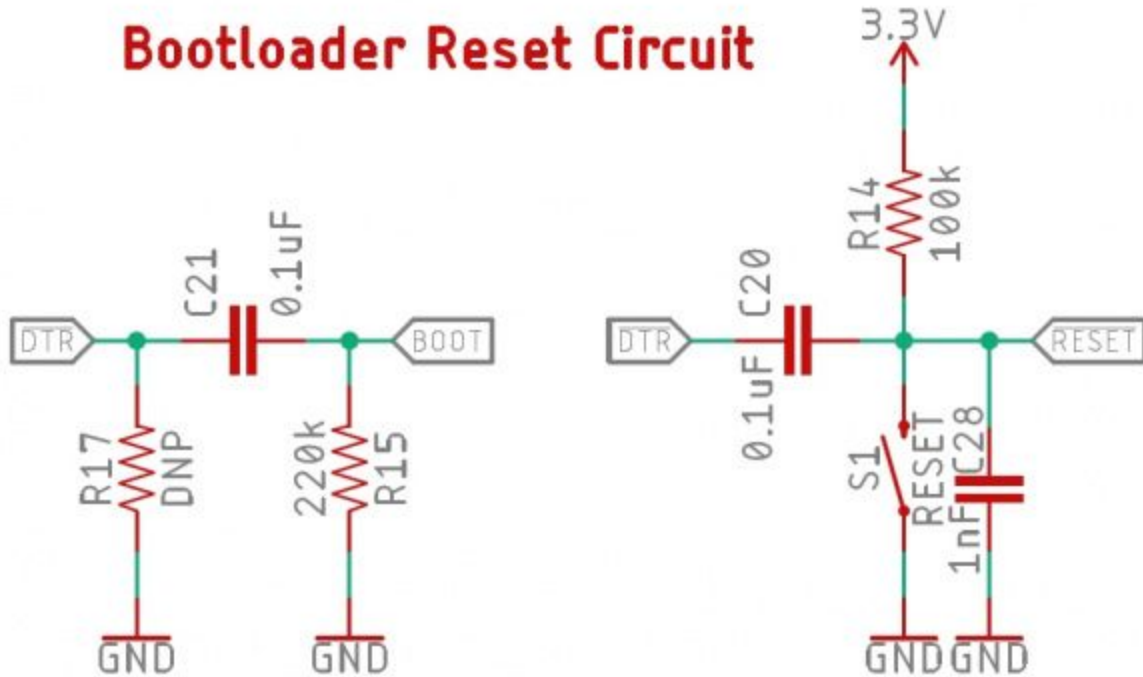

This style of bootloading is slightly different from bootloaders that you may be accustomed to. The STK500 bootloader that runs on most ATmega328 based Arduinos is run automatically at reset, then times out and the user's code is run. The Artemis bootloader is similar but requires an extra pin (the Bootload pin) to be held high. To make using Artemis as cheap and easy as possible we've designed a simple RC circuit that can be implemented on your design using USB-to-serial ICs with the bare minimum control pins (the CH340E has only RTS) and still allow for factory bootloader activation. If you suspect you will need to modify the SparkFun Artemis Bootloader (described above) or if you need to use the secure bootload toolchain, the circuit above can be used to bootload using a single pin (DTR or RTS is supported). This single-pin reset and bootload solution is ideal for any USB to serial implementation that has control pins exposed (CH340, CP210x, FT232, etc).

Heads up! You will never damage or brick the Artemis but using the Ambiq Secure Bootloader tools will overwrite the SparkFun bootloader removing the faster upload abilities. We don't recommend using the Ambiq Secure Bootloader for general Arduino programming.



Don't select Ambiq Secure Bootloader unless you know what you're doing

To load new code onto your Artemis module using the Ambiq bootloader toolchain select the Ambiq Secure Bootloader option in the Arduino Tools->Bootloader menu. These tools will modify your binary and package

them with various security headers. The code will load at 115200bps and may fail. Hit upload again if the process fails.

How the Single Pin RC Circuit Works

By pulling DTR (or RTS) low, the module is reset. After 10ms, DTR is pushed high in software. This causes the bootload pin to be high for 100ms allowing the bootloader to run. Opening of a serial port causes DTR to go low causing the module to reset, but because DTR stays low during normal serial operations the module does not enter the SBL and instead proceeds to run the SparkFun Artemis Bootloader.

We have modified the Ambiq python bootload tool so that both DTR and RTS are driven at the same time, and in the same way, so you can use either RTS or DTR to bootload the Artemis. Our [Ambiq SBL tools](#) then drive DTR/RTS high to enter the the factory bootloader.

If you prefer, the bootload pin can be broken out to a button. When the user holds the button and resets the board the Artemis will enter bootload mode and stay there until a bootload cycle completes or a reset occurs. This method works well but requires the user's interaction every time new code needs to be loaded.

7. Reflow Profile and Cleaning

Cleaning

The use of "No Clean" paste is recommended as it does not require a wash phase after reflow. Washing a final assembly that uses the Artemis is not recommended as water may be captured under the module and/or RF shield causing part degradation.

Recommended Reflow Profile

The Artemis module follows standard reflow handling and processing. Please refer to the Jedec J-STD-020-D.1 reflow profile. Multiple reflow exposures are not recommended.

8. Tape and Reel Packaging

Artemis comes on 24mm reels of 500pcs with 16mm pocket spacing as shown below.

POCKET SIZE	
A ₀ -	11.00mm [.433"]
B ₀ -	16.50mm [.650"]
K ₀ -	2.90mm [.114"]

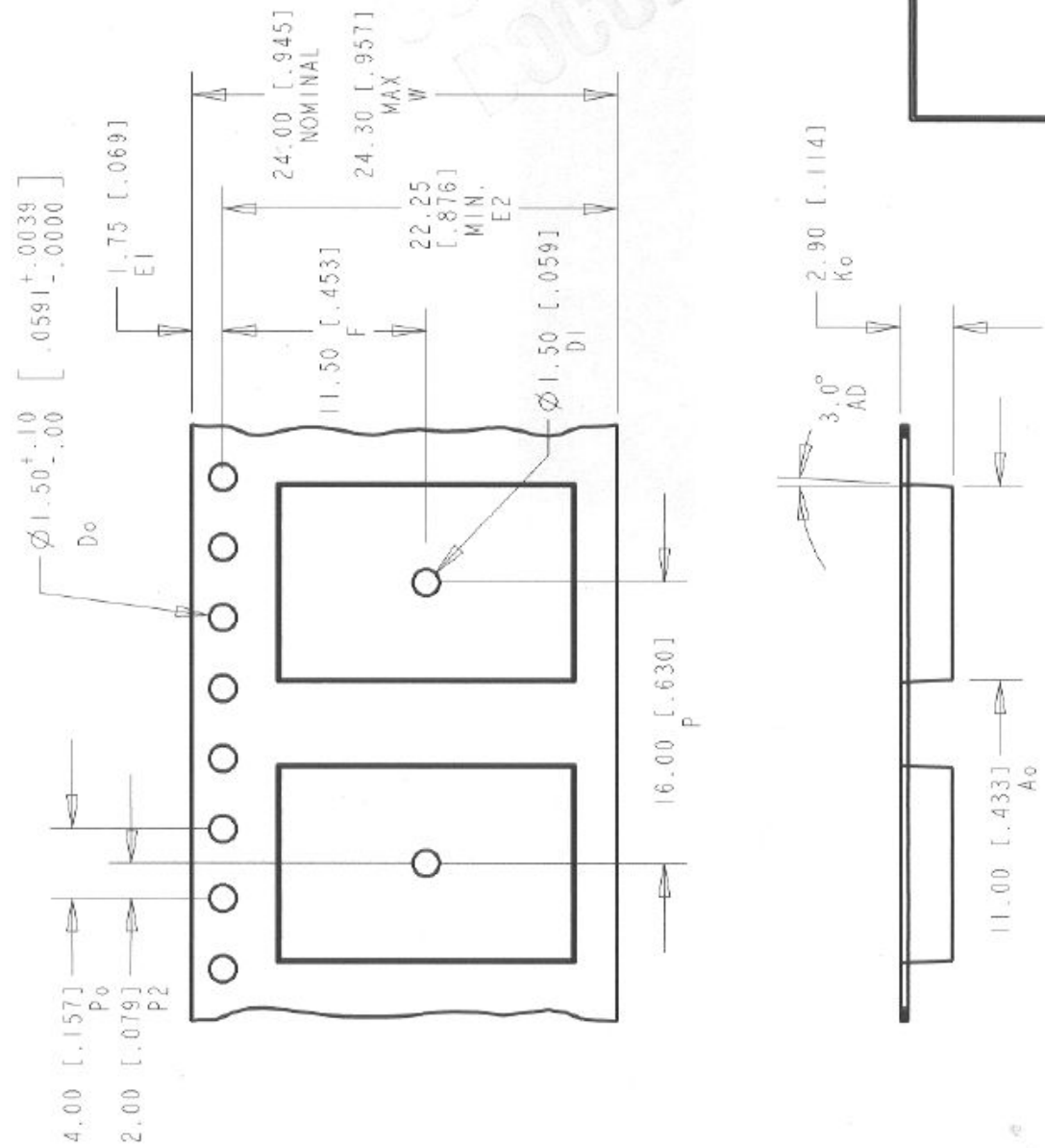

CUSTOMER APPROVAL
TO BUILD MOLD

X _____ DATE _____

PART NO: 100010490	
DRAWN BY: GLP	DATE: 3-31-08
REVISY BY:	SCALE: 2.500
APPROVED BY: <i>[Signature]</i>	DRAWING NO. 015050-00
	REVISION NO. 0

PART CONFORMS TO EIA-481-C STANDARDS

UNLESS OTHERWISE NOTED ALL TOLERANCES ARE AS FOLLOWS:
 ANGLES: $\pm 1^\circ$
 DIM: .XX \pm .10 mm

NOTE:
 1. ALL DIMENSIONS IN MILLIMETERS (INCHES)
 2. 10 SPROCKET HOLE PITCH CUMULATIVE TOLERANCE ± 0.2 mm

THIS DRAWING CONTAINS PROPRIETARY DESIGN INFORMATION AND REMAINS ALONG WITH THE PRODUCT OR PRODUCTS REPRESENTED HERE IN THE PROPERTY OF TEK PAK, INC. THIS DOCUMENT AND THE INFORMATION IT CONTAINS MAY NOT BE COPIED, TRANSMITTED, OR USED BY ANY THIRD PARTY WITHOUT THE EXPRESS WRITTEN APPROVAL OF TEK PAK, INC.

9.Regulator Testing and Configuration

If necessary the Artemis module can be configured for host product evaluation for different operational conditions. In other words, if Artemis is implemented into a host system that needs secondary certifications the Artemis can be loaded with test firmware to put the radio into different constant transmission or reception states to verify the end device does not emit spurious emissions caused by the Artemis. The test firmware and documentation for implementation is located in the Ambiq SDK under 'uart_ble_bridge'.

10. Regulatory Statements

FCC Statements

FCC Statements

This device complies with part 15 of the FCC Rules. Operation is subject to the following two conditions:

- 1) This device may not cause harmful interference, and
- 2) This device must accept any interference received, including interference that may cause undesired operation.

Cet appareil est conforme à la section 15 des réglementations de la FCC. Le fonctionnement de l'appareil est sujet aux deux conditions suivantes :

- 1) cet appareil ne doit pas provoquer d'interférences néfastes, et
- 2) cet appareil doit tolérer les interférences reçues, y compris celles qui risquent de provoquer un fonctionnement indésirable.

Note: This product has been tested and found to comply with the limits for a Class B digital device, pursuant to part 15 of the FCC Rules. These limits are designed to provide reasonable protection against harmful interference in a residential installation. This product generates, uses, and can radiate radio frequency energy and, if not installed and used in accordance with the instructions, may cause harmful interference to radio communications. However, there is no guarantee that interference will not occur in a particular installation. If this product does cause harmful interference to radio or television reception, which can be determined by turning the equipment off and on, the user is encouraged to try to correct the interference by one or more of the following measures:

- Reorient or relocate the receiving antenna.
- Increase the separation between the equipment and receiver.
- Connect the equipment into an outlet on a circuit different from that to which the receiver is connected.
- Consult the dealer or an experienced radio/TV technician for help.

Warning: Changes or modifications to this unit not expressly approved by the party responsible for compliance could void the user's authority to operate the equipment.

FCC Radiation Exposure Statement

This equipment complies with FCC radiation exposure limits set forth for an uncontrolled environment. End users must follow the specific operating instructions for satisfying RF exposure compliance.

FCC Modular Usage Statement

Note 1: This module certified complies with RF exposure requirements under mobile or fixed condition; this module is to be installed only in mobile or fixed applications.

A mobile device is defined as a transmitting device designed to be used in other than fixed locations and to generally be used in such a way that a separation distance of at least 20 centimeters is normally maintained between the transmitter's radiating structure(s) and the body of the user or nearby persons. Transmitting devices designed to be used by consumers or workers that can be easily re-located, such as wireless devices associated with a personal computer, are considered to be mobile devices if they meet the 20 centimeter separation requirement.

A fixed device is defined as a device is physically secured at one location and is not able to be easily moved to another location.

Note 2: Host product manufacturers must provide in their user manual the required RF exposure information for mobile & fixed usage of this module. Host product manufacturers must use the following RF exposure statement in their user manual "This equipment complies with FCC radiation exposure limits set forth for an uncontrolled environment. This equipment should be installed and operated with a minimum distance of 20 cm between the radiator and all persons. This transmitter must not be co-location or operating in conjunction with any other antenna or transmitter."

Note 3: Any modifications made to the module will void the Grant of Certification, this module is limited to OEM installation only and must not be sold to end-users, end-user shall have no manual instructions to remove or install the device, only software or operating procedure shall be placed in the end-user operating manual of final products.

Note 4: Additional testing and certification may be necessary when multiple modules are used.

Note 5: The module may be operated only with the integral chip antenna with which it is authorized.

Note 6: To ensure compliance with all non-transmitter functions the host manufacturer is responsible for ensuring compliance with the module(s) installed and fully operational. For example, if a host was previously authorized as an unintentional radiator under the Supplier's Declaration of Conformity procedure without a transmitter certified module and a module is added, the host manufacturer is responsible for ensuring that the after the module is installed and operational the host continues to be compliant with the part 15B unintentional radiator requirements. Since this may depend on the details of how the module is integrated with the host, the manufacturer shall provide guidance to the host manufacturer for compliance with the part 15B requirements.

Note 7: The FCC ID label on the final system must be labeled with "Contains FCC ID: 2ASW8- ART3MIS" or "Contains transmitter module FCC ID: 2ASW8- ART3MIS".

Note 8: The FCC rule/s for this module are CFR 47 Part 15 Subpart C.

Note 9: This modular transmitter is only FCC authorized for the specific rule parts listed on its grant. The host product manufacturer is responsible to any other FCC rules that apply to the host not covered by the modular

transmitter grant of certification. The final host product will require Part 15 Subpart B compliance when the modular transmitter is installed.

ISED Statements

This device complies with Innovation, Science and Economic Development Canada's license-exempt RSS standard(s). Operation is subject to the following two conditions:

- 1) this device may not cause interference, and
- 2) this device must accept any interference, including interference that may cause undesired operation of the device.

Le présent appareil est conforme aux CNR d'Innovation, Sciences et Développement Économique Canada applicables aux appareils radioexempts de licence. L'exploitation est autorisée aux deux conditions suivantes :

- 1) l'appareil ne doit pas produire de brouillage, et
- 2) l'utilisateur de l'appareil doit accepter tout brouillage radioélectrique subi, même si le brouillage est susceptible d'en compromettre le fonctionnement.

Under Innovation, Science and Economic Development Canada's regulations, this radio transmitter may only operate using the integral antenna under which it was approved.

Conformément à la réglementation d'Innovation, Sciences et Développement Économique Canada, le présent émetteur radio peut fonctionner avec une antenne fonctionner qu'en utilisant l'antenne intégrée sous laquelle il a été approuvé.

ISED RF Exposure Statement

This equipment complies with ISED radiation exposure limits set forth for an uncontrolled environment. This equipment should be installed and operated with minimum distance 20cm between the radiator & your body. This transmitter must not be co-located or operating in conjunction with any other antenna or transmitter.

Le rayonnement de la classe b respecte ISED fixaient un environnement non contrôlés. Installation et mise en œuvre de ce matériel devrait avec échangeur distance minimale entre 20 cm ton corps. Lanceurs ou ne peuvent pas coexister cette antenne ou capteurs avec d'autres.

ISED Modular Usage Statement

NOTE 1: When the ISED certification number is not visible when the module is installed inside another device, then the outside of the device into which the module is installed must also display a label referring to the enclosed module. This exterior label can use the wording "Contains transmitter module IC: 25186-ART3MIS" or "Contains IC: 25186-ART3MIS".

NOTE 1: Lorsque le numéro de certification ISED n'est pas visible lorsque le module est installé dans un autre appareil, l'extérieur de l'appareil dans lequel le module est installé doit également afficher une étiquette faisant référence au module inclus. Cette étiquette extérieure peut être libellée Contient le module émetteur IC: 25186-ART3MIS ou Contient IC: 25186-ART3MIS.

11. Revision History

Revision	Date	Description
1p0p0	June-2-2019	Initial Release
1p0p1	July-23-2019	Add Regulatory Statements Add Programming Move recommended layout to new section
1p0p2	August-9-2019	Update regulator information. Add regulatory testing section. Add reflow information. Add tape and reel diagram.
1p0p3	August-12-2019	Updated regulator information.