

EVK-U20, EVK-U23

LISA-U200, LISA-U230

HSPA+/UMTS/EGPRS/GSM

Cellular evaluation kit

User Guide

Abstract

This guide explains how to set up the EVK-U20 and EVK-U23 evaluation kits to begin evaluating the u-blox LISA-U2 series HSPA+/UMTS/EGPRS/GSM cellular modules.



Document Information

Title	EVK-U20, EVK-U23		
Subtitle	LISA-U200, LISA-U230 HSPA+/UMTS/EGPRS/GSM Cellular evaluation kit		
Document type	User Guide		
Document number	UBX-13001794		
Revision and Date	R07	29-Jul-2015	
Document status	Early Production Information		

Document status explanation

Objective Specification	Document contains target values. Revised and supplementary data will be published later.
Advance Information	Document contains data based on early testing. Revised and supplementary data will be published later.
Early Production Information	Document contains data from product verification. Revised and supplementary data may be published later.
Production Information	Document contains the final product specification.

This document applies to the following products:

Product name	Type number	Firmware version	PCN / IN
EVK-U20	EVK-U20-03S-01	N/A	N/A
EVK-U23	EVK-U23-00S-01	N/A	N/A

u-blox reserves all rights to this document and the information contained herein. Products, names, logos and designs described herein may in whole or in part be subject to intellectual property rights. Reproduction, use, modification or disclosure to third parties of this document or any part thereof without the express permission of u-blox is strictly prohibited.

The information contained herein is provided "as is" and u-blox assumes no liability for the use of the information. No warranty, either express or implied, is given, including but not limited, with respect to the accuracy, correctness, reliability and fitness for a particular purpose of the information. This document may be revised by u-blox at any time. For most recent documents, please visit www.u-blox.com. Copyright © 2015, u-blox AG.

u-blox® is a registered trademark of u-blox Holding AG in the EU and other countries.

Trademark Notice

Microsoft and Windows are either registered trademarks or trademarks of Microsoft Corporation in the United States and/or other countries. All other registered trademarks or trademarks mentioned in this document are property of their respective owners.

Contents

Contents.....	3
1 Starting up.....	4
1.1 EVK-U2x overview	4
1.2 EVK-U2x block diagram	5
1.3 Switches, jumpers and buttons	5
1.4 Connectors.....	6
1.5 LEDs	6
1.6 EVK-U2x pinout.....	7
1.7 Software installation.....	7
1.8 Board setup and settings	8
1.9 Enabling verbose error result codes.....	9
1.10 PIN code insertion (when required).....	9
1.11 Registration on a cellular network.....	9
1.12 Audio codec configuration and enabling / disabling.....	10
1.13 Switching off the EVK-U2x	10
Appendix	11
A Setting up AT terminal applications for communication with EVK-U2x	11
B Setting up cellular packet data connection on PC.....	12
B.1 How to install and configure a low data rate modem connection	12
B.2 How to install and configure a high data rate modem connection	15
C Examples of AT commands.....	17
C.1 Voice call.....	17
C.2 Data call (CSD mode).....	17
C.3 SMS management	18
C.4 Internet connection in GPRS mode (using external TCP/IP stack)	18
C.5 Internet connection in GPRS mode (using internal TCP/IP stack).....	18
C.6 Enable communication between cellular and GNSS modules	19
C.7 Read NMEA messages (example: GLL).....	19
C.8 GNSS AssistNow	19
Declaration of conformities.....	20
Related documents	20
Revision history.....	20
Contact.....	21

1 Starting up

1.1 EVK-U2x overview

The EVK-U20 and EVK-U23 are powerful and easy-to-use tools that make evaluating the u-blox LISA-U200 and LISA-U230 HSPA+/UMTS/EGPRS/GSM cellular modules simple.

The evaluation kits differ depending on which LISA-U2 series module version is mounted:

- LISA-U200 module is provided on the EVK-U20 evaluation kit
- LISA-U230 module is provided on the EVK-U23 evaluation kit

This document identifies both evaluation kits as EVK-U2x.

This section describes the main connections and settings required to get started.



EVK-U2x can also be used to evaluate the LISA-U2 series modules: LISA-U201, LISA-U260, LISA-U270.



See the LISA-U2 series Data Sheet [2] and the LISA-U series System Integration Manual [3] for the features supported by u-blox LISA-U2 series HSPA+/UMTS/EGPRS/GSM cellular modules.

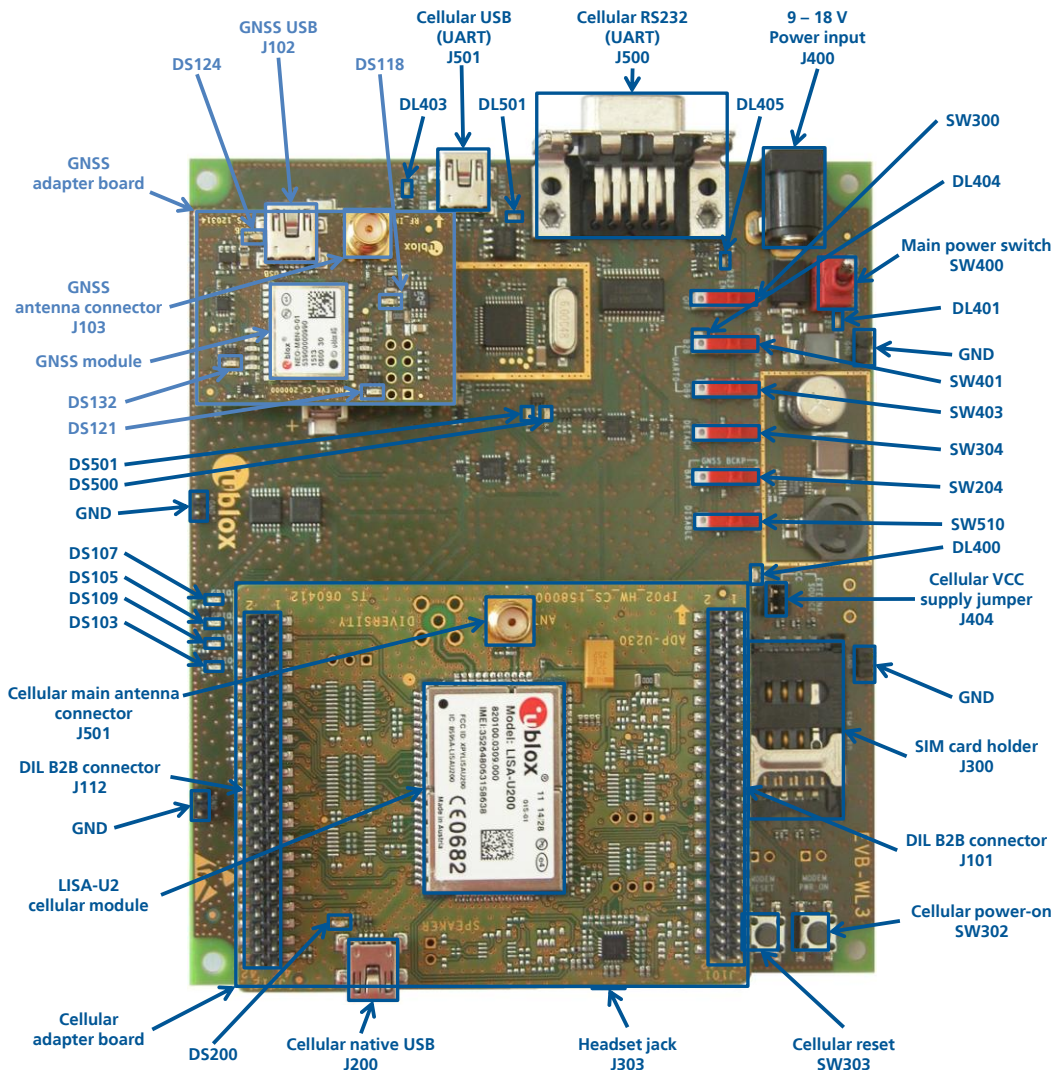

Figure 1: EVK-U2x evaluation kit overview

1.2 EVK-U2x block diagram

Figure 2 shows the main interfaces and internal connections of the EVK-U2x:

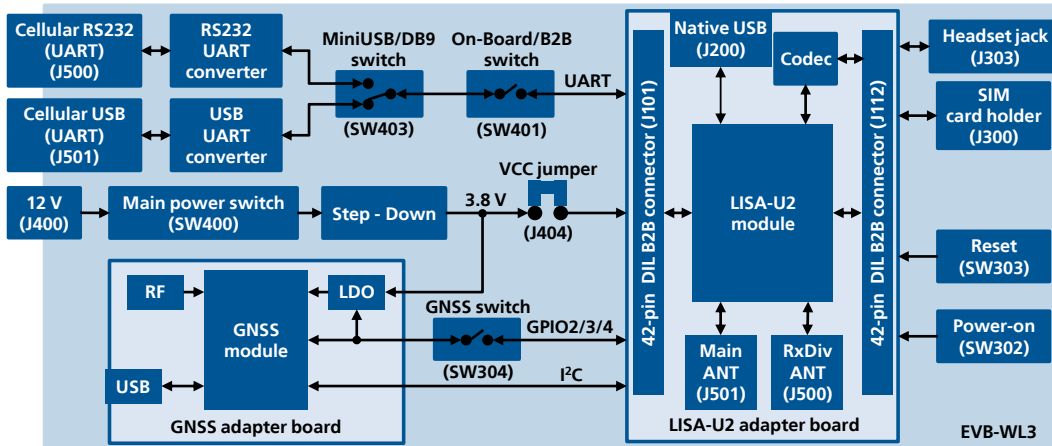

Figure 2: EVK-U2x block diagram

The EVK-U2x is formed by three boards:

- The lower one, called EVB-WL3, contains the power supply and other peripherals for the LISA-U2 series cellular module (SIM card holder, Reset button and Power-on button).
- The cellular adapter board, called ADP-U200 or ADP-U230 contains the LISA-U200 or the LISA-U230 cellular module, the antennas and USB connectors for the cellular module.
- The GNSS adapter board, called ADP-GNSS, contains the u-blox GNSS module, the GNSS antenna connector and the USB connector for the GNSS module.

The boards are connected by means of male header board-to-board connectors provided on the bottom of the adapter boards and their corresponding female connectors provided on top of the lower board

The USB interface of the cellular module is available on the cellular native USB connector on the adapter board, while the other peripherals are available on the Dual-In-Line male Board-to-Board connectors provided on the top layer of the adapter board (J101, J112), which are pin-to-pin compatible to the connectors on the bottom layer of the adapter board.

1.3 Switches, jumpers and buttons

Function	Description	Name	Board
Main Power Switch	Switch to power on / off the whole evaluation kit	SW400	EVB
Cellular VCC	Jumper socket to provide the 3.8 V supply to the cellular module VCC input	J404	EVB
Cellular Power-on	Push button to switch-on the cellular module	SW302	EVB
Cellular Reset	Push button to reset the cellular module	SW303	EVB
Cellular UART detach	Slide switch to attach / detach cellular module UART from USB and RS232 connectors: when detached, UART signals available only on the DIL B2B connector on ADP board	SW401	EVB
Cellular UART routing	Slide switch to select cellular module UART routing on USB or on RS232 connector	SW403	EVB
Cellular GPIO detach	Slide switch to attach / detach the cellular module GPIOs, SIM_DET from peripherals: when detached, the signals are available only on the DIL B2B connector on ADP board	SW300	EVB
Cellular GNSS detach	Slide switch to attach / detach the cellular module to the GNSS module (GPIO2-3-4): when detached, the signals are available only on DIL B2B connector on ADP board	SW304	EVB
GNSS V_BCKP	Slide switch to connect / disconnect backup battery to V_BCKP pin of GNSS module	SW204	EVB

Table 1: EVK-U2x switches and buttons description

1.4 Connectors



Function	Description		Name	Board
9 - 18 V Power Input	Connector for the AC / DC power adapter of the EVK AC: 100-240 V, 0.8 A, 50-60 Hz / DC: +12 V, 2.5 A		J400	EVB
Cellular main antenna	SMA connector for the cellular module main antenna		J501	ADP-U2xx
Cellular Rx div antenna	SMA connector for the cellular module Rx diversity antenna		J500	ADP-U2xx
SIM card holder	SIM card holder		J300	EVB
Cellular native USB	Mini USB connector for cellular module native USB interface		J313	ADP-U2xx
Cellular USB (UART)	Mini USB connector for cellular module UART interface converted as USB interface		J501	EVB
Cellular RS232 (UART)	DB9 connector for cellular module UART interface converted as RS232 interface		J500	EVB
Cellular headset	Audio headset jack connector for cellular module audio interface		J303	EVB
DIL B2B headers	Dual-In-Line Board-to-Board connectors for cellular module interfaces		J101, J112	ADP-U2xx
GNSS antenna	SMA connector for the GNSS module antenna (GNSS antenna)		J103	ADP-GNSS
GNSS USB	Mini USB connector for GNSS module USB interface		J102	ADP-GNSS
GNSS backup battery	Backup battery socket for the GNSS module (under GNSS adapter board)		BT200	EVB
GND	Ground terminals for probe reference		J402/3/5/6	EVB

Table 2: EVK-U2x connectors' description

 **Caution! In the unlikely event of a failure in the internal protection circuitry there is a risk of an explosion when charging fully or partially discharged battery. Replace battery when it no longer has sufficient charge for unit operation. Control the battery before use if the device has not been used for an extended period of time.**

 **Caution! Risk of explosion if battery is replaced with an incorrect type. Dispose of used batteries according to the instructions!**

1.5 LEDs















Function	Description	LED #	Board	Color
Main Power	Power supply plugged in the 9 - 18 V Power Input	DL401	EVB	
Cellular VCC supply	Cellular module supplied. Main Power Switch must be switched on	DL400	EVB	
Cellular native USB	USB cable plugged in Cellular native USB connector	DS200	ADP-U2xx	
Cellular USB	USB cable plugged in Cellular USB connector for UART access	DL501	EVB	
Cellular USB / UART	Green light is activated when UART is routed to Cellular USB connector Red light blinks at UART TX or RX data on Cellular USB connector	DL403	EVB	
Cellular RS232 / UART	Green light is activated when UART is routed to Cellular RS232 connector Red light blinks at UART TX or RX data on Cellular RS232 connector	DL405	EVB	
Cellular UART detach	UART signals are available only on the DIL B2B connector on ADP board	DL404	EVB	
Cellular RI indicator	RI line turns ON (active low)	DS501	EVB	
Cellular CTS indicator	CTS line turns ON (active low)	DS500	EVB	
Cellular GPIOs indicators	Green light is activated when cellular GPIO1 is high Green light is activated when cellular GPIO2 is high Green light is activated when cellular GPIO3 is high Green light is activated when cellular GPIO4 is high	DS107 DS105 DS109 DS103	EVB EVB EVB EVB	
GNSS VCC supply	GNSS module supply is turned ON	DS118	ADP-GNSS	
GNSS USB	USB cable plugged in GNSS USB connector	DS124	ADP-GNSS	
GNSS timepulse	Pulses at 1 Hz when valid GNSS fix	DS121	ADP-GNSS	
Cellular / GNSS DDC	Cellular / GNSS module communication over DDC (I ² C) interface	DS132	ADP-GNSS	

Table 3: EVK-U2x LEDs' description

1.6 EVK-U2x pinout

DIL Name/Pin Number	LISA Signal Name	LISA Pin N°	LISA Pin N°	LISA Signal Name	DIL Name/Pin Number
J112 Pins 7-8-9-10	GND	1	65	GND	J112 Pins 7-8-9-10
J112 Pin 3	V_BCKP	2	64	GND	J112 Pins 7-8-9-10
J112 Pins 7-8-9-10	GND	3	63	VCC	J101 Pins 7-8-9-10
J112 Pin 36	V_INT	4	62	VCC	J101 Pins 7-8-9-10
J112 Pin 22	RSVD	5	61	VCC	J101 Pins 7-8-9-10
J112 Pins 7-8-9-10	GND	6	60	GND	J112 Pins 7-8-9-10
J112 Pins 7-8-9-10	GND	7	59	SPI_MRDY / GPIO14	J112 Pin 37
J112 Pins 7-8-9-10	GND	8	58	SPI_SRDY / GPIO13	J112 Pin 39
J112 Pin 18	DSR	9	57	SPI_MISO / GPIO12	J101 Pin 17
J112 Pin 17	RI	10	56	SPI_MOSI / GPIO11	J101 Pin 18
J112 Pin 11	DCD	11	55	SPI_SCLK / GPIO10	J101 Pin 19
J112 Pin 12	DTR	12	54	GPIO9 / I2S1_WA	J112 Pin 30
J112 Pin 13	RTS	13	53	GPIO8 / I2S1_CLK	J112 Pin 34
J112 Pin 14	CTS	14	52	RSVD / CODEC_CLK	J112 Pin 24
J112 Pin 15	TXD	15	51	GPIO5	J112 Pin 23
J112 Pin 16	RXD	16	50	VSIM	J101 Pin 13
J112 Pins 7-8-9-10	GND	17	49	SIM_RST	J101 Pin 16
Not present	VUSB_DET	18	48	SIM_IO	J101 Pin 14
J112 Pin 29	PWR_ON	19	47	SIM_CLK	J101 Pin 15
J112 Pin 33	GPIO1	20	46	SDA	J101 Pin 21
J112 Pin 31	GPIO2	21	45	SCL	J101 Pin 20
J101 Pin 26	RESET_N	22	44	RSVD / I2S_RXD	J101 Pin 23
J112 Pin 32	GPIO3	23	43	RSVD / I2S_CLK	J101 Pin 22
J112 Pin 25	GPIO4	24	42	RSVD / I2S_TXD	J101 Pin 24
J112 Pins 7-8-9-10	GND	25	41	RSVD / I2S_WA	J101 Pin 25
Not present	USB_D-	26	40	GPIO7 / I2S1_TXD	J112 Pin 28
Not present	USB_D+	27	39	GPIO6 / I2S1_RXD	J112 Pin 27

Table 4: Cellular module interfaces availability on the 42-pins Dual-In-Line Board-to-Board connectors on the Adapter Board

1.7 Software installation

The USB driver can be downloaded from the EVK-U2x collection found on u-blox.com/evk-downloads. Save the executable file to any location of the hard drive on the computer. The installation can be started by running the executable file on the computer running the Windows operating system.

1.8 Board setup and settings

- 1 Insert a SIM card into the **SIM card holder** (J300).
- 2 Connect a cellular antenna provided with the evaluation kit box to the **Cellular main antenna** SMA connector (J501 on ADP-U2xx, RF input/output for transmission and reception of 3G/2G RF signals).
- 3 In case of EVK-U23, connect a cellular antenna provided with the evaluation kit box to the **Cellular Rx div antenna** SMA connector (J500 on ADP-U2xx, RF input for reception of 3G RF signals as per DL Rx diversity). Place the Rx div cellular antenna far enough from the main cellular antenna (should be more than 20 cm).
- 4 If the GNSS functionality is required, connect the GNSS antenna provided with the evaluation kit box to the **GNSS antenna** SMA connector (J103 on ADP-GNSS). Put the GNSS antenna in a place with good sky view.
- 5 Connect the AC / DC +12 V power adapter provided with the evaluation kit box to **9 – 18 V Power Input** connector (J400 on EVB). LED DL401 lights blue.
- 6 Be sure to insert a jumper socket on the **Cellular VCC supply jumper** (J404). This provides the connection from the 3.8 V output of the supply circuit on the EVB to the VCC input of the module.
- 7 To enable board power supply, turn **Main Power** switch (SW400) to ON position. LED DL400 lights green. The cellular module switches on.



If the cellular module is powered off using AT+CPWROFF command, press the **Cellular Power ON** button (SW302) or the **Cellular Reset** button (SW303) to switch on the module again.

- 8 For communication via UART interface of the cellular module, the following connections are allowed and can be alternatively enabled in a mutually exclusive way (see Table 5 for switch position and LED status):
 - a. Connect a USB cable to the mini USB connector (**Cellular USB**, J501 on EVB), LED DL501 lights blue
 - b. Connect an RS232 cable to DB9 connector (**Cellular RS232**, J500 on EVB)

When a USB cable is connected to the mini USB connector, two COM ports are enabled in Windows (the numbering of the COM ports can be seen via the Windows Device Manager). The serial port for AT commands is available over the first numbered COM port opened by the driver.

Type of connections	SW401	SW403	LED
Access to cellular UART over the Cellular USB (UART) mini USB connector (J501)	ON BOARD	MINIUSB	DL403
Access to cellular UART over the Cellular RS232 (UART) DB9 connector (J500)	ON BOARD	DB9	DL405
Access to cellular UART on DIL Board-to-Board connector on the adapter board: cellular UART detached from USB (UART) J501 and RS232 (UART) J500 connectors	B2B	Do not care	DL404

Table 5: Cellular UART interface configuration and routing

- 9 For communication via USB interface of the cellular module, connect a USB cable to Cellular Native USB connector (J313 on ADP). LED DL300 on ADP lights blue.

After the end of the module boot, the COM ports listed in Table 6 are enabled by the Windows USB driver (details as the numbering of the ports can be seen via the Windows Device Manager)¹:

Parameter	Type	Remarks
u-blox Modem USB1 AT and data	Modems	AT command interface and data communication
u-blox Modem USB2 AT and data	Ports (COM & LPT)	AT command interface and data communication
u-blox Modem USB3 AT and data	Ports (COM & LPT)	AT command interface and data communication
u-blox Modem USB4 GNSS	Ports (COM & LPT)	GNSS tunneling
u-blox Modem USB5 Primary Log	Ports (COM & LPT)	Diagnostic purpose
u-blox Modem USB6 Secondary Log	Ports (COM & LPT)	Diagnostic purpose
u-blox Modem USB7 SAP	Ports (COM & LPT)	Remote SIM Access profile

Table 6: COM-ports in use for Cellular Native USB ports

¹ A message of "driver installation fail" may appear on Windows if the USB cable has been connected before the end of the module boot, but this can be ignored as the normal operating functionality of the module will be anyway available after the end of the module boot.



When using USB drivers for Windows, if a dial-up connection is created and then started on the “Modems Type” interface (USB1), the following commands are issued to the module through USB1 during the dial-up initialization phase:

```
AT&F&D2&C1S0=0<cr> ATE0V1<cr> AT\Q0<cr>
```

These commands reset all profile parameters to factory-programmed values. This is strictly related to the provided Windows modem driver, and is not controlled by the FW module. If needed, profile parameters other than the factory-programmed values must be set after the dial up connection is disconnected.

10 Run an AT terminal application (e.g. m-center, HyperTerminal) on PC COM-port, with these settings:

- o Data rate: 115200 b/s
- o Data bits: 8
- o Parity: N
- o Stop bits: 1
- o Flow control: HW

See Appendix A for how to configure the AT-Terminal for Windows-XP, Windows 7 and Vista.

11 Connect the headset provided with the evaluation kit box to the **Headset jack** connector (J303 on EVB), if the audio functionality is required.

1.9 Enabling verbose error result codes

Command sent by DTE (user)	DCE response (modem)	Description
AT+CMEE=2	OK	Enables cellular module to report verbose error result codes.

1.10 PIN code insertion (when required)

Command sent by DTE (user)	DCE response (modem)	Description
AT+CPIN="8180"	OK	Enter the PIN code, if needed (enter the PIN of the SIM card – 8180 is written here as an example).
AT+CLCK="SC", 0, "8180"	OK	Unlock the PIN at power on (the last parameter is the PIN of the SIM card – 8180 is written here as an example).
AT+CLCK="SC", 1, "8180"	OK	Lock the PIN at power on (the last parameter is the PIN of the SIM card – 8180 is written here as an example).

1.11 Registration on a cellular network

Command sent by DTE (user)	DCE response (modem)	Description
AT+CREG?	+CREG: 0, 1 OK	Verify the network registration.
AT+COPS=0	OK	Register the phone on the network. The cellular module automatically registers itself on the cellular network. This command is necessary only if the automatic registration failed (AT+CREG? returns 0,0).
AT+URAT=1, 2	OK	Select radio access technology: 1=GSM/UMTS dual mode; 2=UMTS.
AT+COPS?	+COPS: 0, 0, "I TIM", 2 OK	Read operator name; 2 means radio access UMTS.

1.12 Audio codec configuration and enabling / disabling

Command sent by DTE (user)	DCE response (module)	Description
AT+UGPIOC?	+UGPIOC: 16,255 23,3 24,4 25,5 34,12 35,12 36,12 37,12 42,7 OK	Check the I2S pins (<gpio_id> = 34, 35, 36, 37) configuration: they must be configured as I2S digital audio interface (<gpio_mode> = 12) to provide voice capability at the EVB headset jack connector using the external audio codec mounted on the EVK-U2x.
AT+USPM?	+USPM: 0,0,0,0,2 OK	Check the audio path mode setting: both the <main_uplink> path and the <main_downlink> path must be configured as I2S digital audio interface (e.g. <main_uplink> = 0, <main_downlink> = 0) to provide voice capability at the EVB headset jack connector using the external audio codec mounted on the EVK-U2x.
AT+UEXTDCONF=0,1	OK	The audio codec configuration is enabled at any subsequent re-boot of the module, with the execution of the following actions: <ul style="list-style-type: none"> • Set module CODEC_CLK pin to provide 13 MHz master clock to the external Maxim MAX9860 audio codec mounted on EVK-U2x • Open the DDC logical channel connected to the external codec • Send, via DDC, the specified byte sequence for codec configuration • Close the DDC logical channel connected to the external codec Note that the AT+UEXTDCONF setting must be saved in the module' non volatile memory by switching off the module with AT+CPWROFF to be in use at any subsequent re-boot of the module.
AT+UEXTDCONF=0,0	OK	The audio codec configuration is disabled at any subsequent re-boot of the module. Note that the AT+UEXTDCONF setting must be saved in the module' non volatile memory by switching off the module with AT+CPWROFF to be in use at any subsequent re-boot of the module.

1.13 Switching off the EVK-U2x

To switch off the EVK-U2x, send the AT+CPWROFF command. Make sure to use this command before switching off the main power, otherwise settings and configuration parameters may not be saved on EVK-U2x.

Appendix

A Setting up AT terminal applications for communication with EVK-U2x

The u-blox m-center cellular module evaluation tool is a powerful platform for evaluating, configuring and testing u-blox cellular products. m-center includes an AT commands terminal for communication with the device and can be downloaded free-of-charge from our website (<http://www.u-blox.com>).

1. Follow the board setup instructions in section 1.8 to provide all the required connections and switching on the cellular module.
2. Run the m-center tool: after the m-center start-up, the **Home** page appears.
3. On the **Home** page, set up the AT COM port; for the setting values see section 1.8.

Check with Windows Device Manager to find out which COM port is being used by EVK-U2x.

4. Enable the connection to u-blox cellular module by clicking on the **Connect** button.
5. Retrieve the module and network information by clicking on the **Get Info** button.

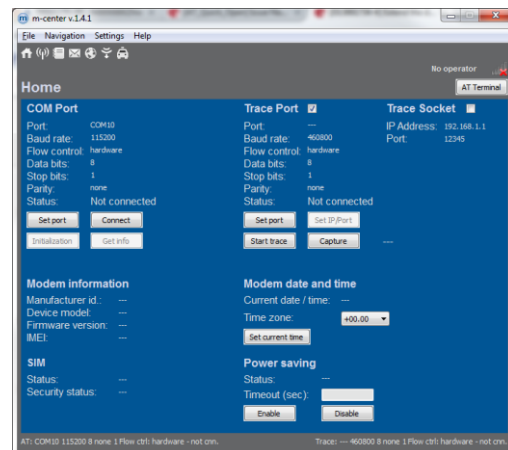

Figure 3: m-center Home page

6. The module information is retrieved and displayed on the **Home** page.
7. Click on the **AT Terminal** button, found at the upper right of the **Home** page. A new window opens and the AT command terminal is now ready for communication with EVK-U2x.

8. The AT terminal is ready to use.

For the complete list of AT commands supported by the modules and their syntax, see the u-blox AT Commands Manual [1].

For more information on using the m-center tool, see the m-center User Guide [4].

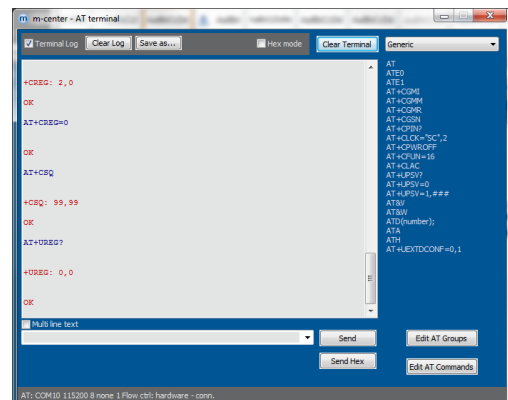

Figure 4: AT Terminal window

B Setting up cellular packet data connection on PC

This section describes how to set up a packet data connection with Windows 7 operating systems (for PC) and EVK-U2x, using the TCP/IP stack of the PC (external TCP/IP stack).

The following examples describe how to install and configure two different kinds of modem on Windows:

1. Low data rate modem, over the UART interface of the cellular module connected to the Windows PC by the **Cellular USB** connector (J501 on EVB) or the **Cellular RS232** connector (J500 on EVB)
2. High data rate modem, over the native USB interface of the cellular module connected to the Windows PC by the **Cellular Native USB** connector (J313 on ADP)

B.1 How to install and configure a low data rate modem connection

This example describes how to install and configure a low data rate packet data connection on a PC with Windows 7 operating system. This uses the TCP/IP stack of the PC over the UART interface of the cellular module connected to the Windows PC by the **Cellular USB** connector (J501 on EVB) or the **Cellular RS232** connector (J500 on EVB).

1. Follow the board setup instructions in section 1.8 to provide the required connections with EVK-U2x.

2. Select "Control panel > Phones and Modem > Modems > Add". This opens the Install New Modem Wizard.
3. Select the **Don't detect my modem** checkbox.

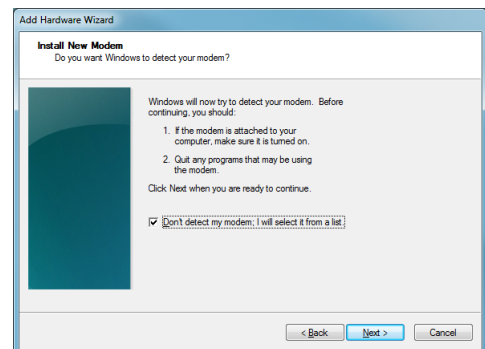

4. Select the Standard Modem (33600 b/s).

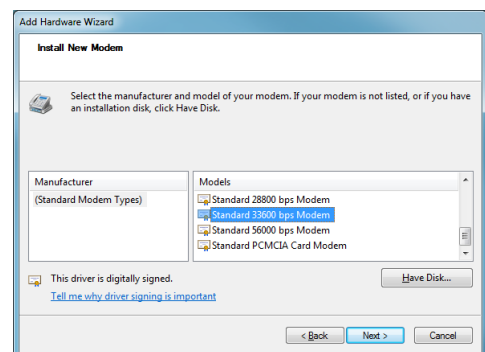

5. Set the COM-port on which the modem will be installed.

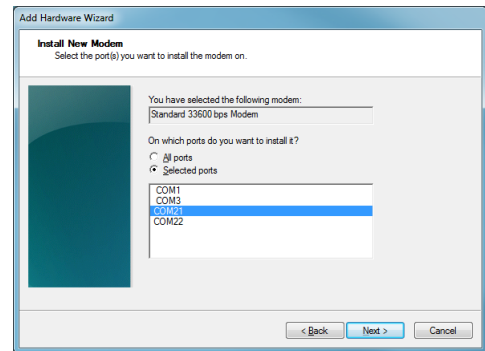

6. Select "Control panel > Phones and Modem > Modems > Standard Modem 33600 bps Modem > Properties".

7. Select "Change Settings > Advanced".

8. Add APN settings command (APN shown in the picture is an example. Make sure to have the correct APN defined by the network operator).

9. Click on **Change Default Preferences**.

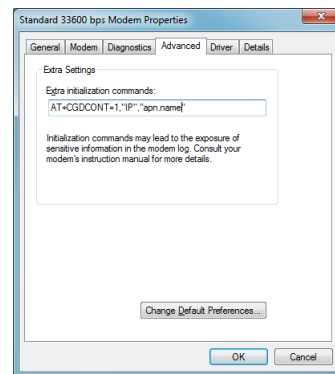

10. Click on **OK** twice and the new connection is now ready to be configured.

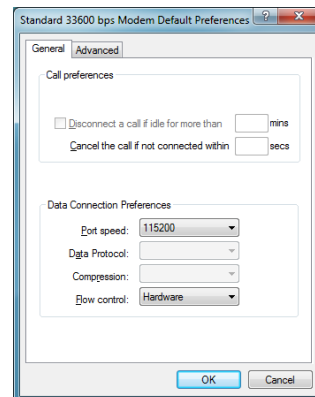

The modem can also be configured using the Device Manager by clicking on the modem name.

11. To configure a new connection, select "Control Panel > Network and Sharing Center > Set up a new connection or network".

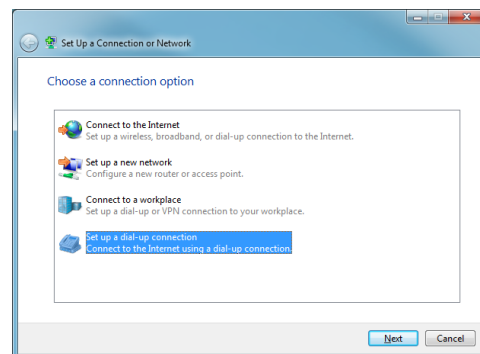

12. Select the modem, if requested (the question appears only if more than one modem is available).

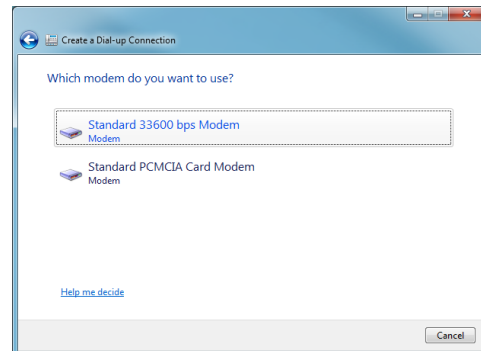

13. Enter parameters for dial-up connection:

- The module telephone number (*99***1#)
- The specific GPRS account information for the network operator
- A name for the new connection (e.g. "u-blox GPRS Connection")

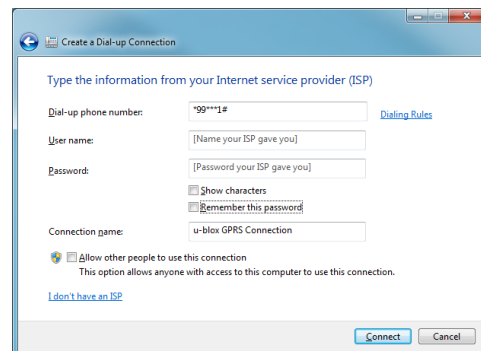

14. The packet data connection is now ready to be used with the EVK-U2x. To check the connection, start a browser.



Consult the cellular network operator for username and password. In most cases, these can be left empty.

B.2 How to install and configure a high data rate modem connection

This example describes how to install and configure a high data rate packet data connection on a PC with the Windows 7 operating system, using the TCP/IP stack of the PC, over the native USB interface of the cellular module connected to the Windows PC by the **Cellular Native USB** connector (J200 on ADP).

1. Follow the board setup instructions in section 1.8 to provide the required connections with EVK-U2x.

2. Select: "Control Panel > Network and Internet > Network and Sharing Center > Setup a new connection or network" This opens the "Choose a connection option" Wizard.

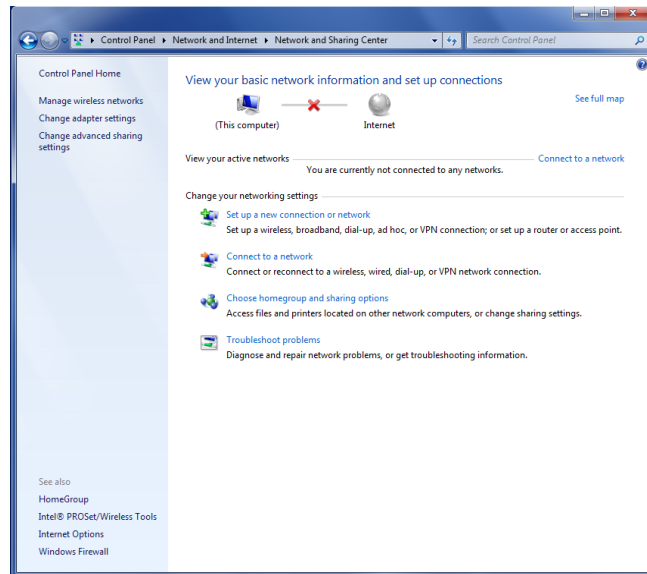

3. Select **Set up a dial-up connection**. Click on **Next**.

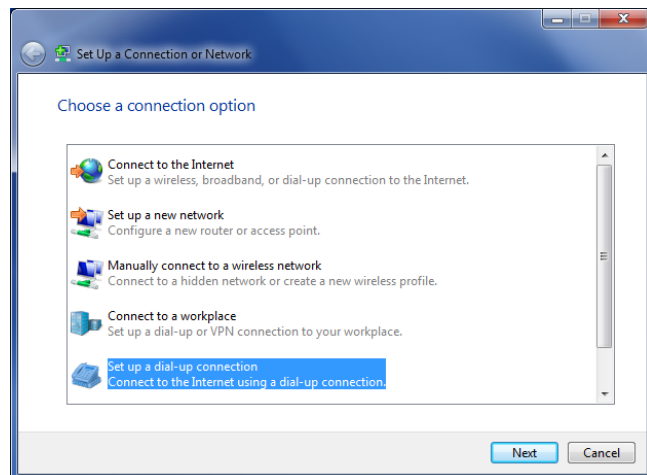

4. Select **u-blox Modem USB1 AT and Data #X** (X=7 in the picture).

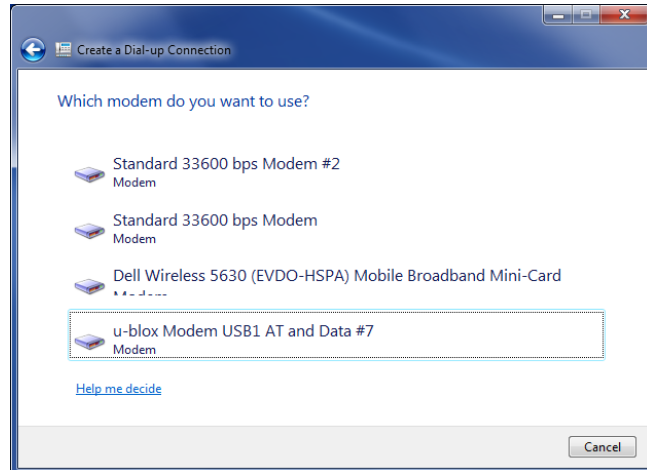

5. Enter the modem telephone number (*99***1#), select **Allow other people to use this connection** and click **Connect** to finalize the procedure.

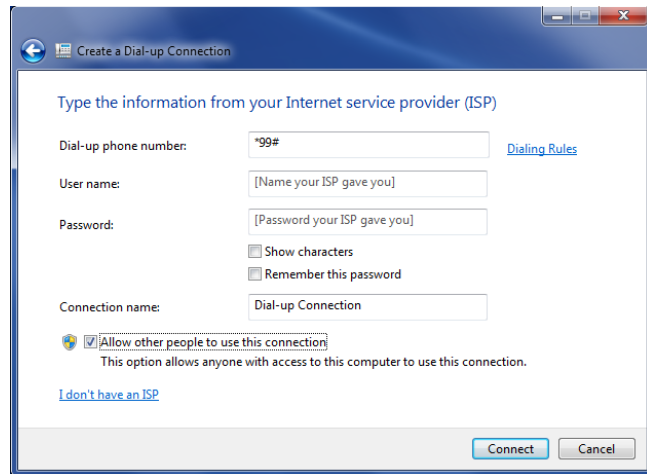

Consult the cellular network operator for username and password. In most cases, these can be left empty.

C Examples of AT commands

For the complete description and syntax of supported AT commands, see the u-blox AT commands Manual [1].

C.1 Voice call

Incoming voice call:

Command sent by DTE (user)	DCE response (module)	Description
AT+CLIP=1	OK	Activation of Caller line ID presentation.
	RING	Call the phone number of the SIM in the device.
	RING	Incoming Call.
	+CLIP: "+3930012345678",145,,,,,0 RING +CLIP: "+3930012345678",145,,,,,0	Presentation of Caller ID: +3930012345678 is written here as example.
ATA	OK	Answer to the voice call.
ATH	OK	Talk to the caller using the headset. Hang up.

Outgoing voice call:

Command sent by DTE (user)	DCE response (module)	Description
AT+CLIP=1	OK	Activation of caller line ID presentation.
ATD+3930012345678;	OK	Outgoing voice call (+3930012345678 is written here as example).
		The voice call is accepted from the network.
ATH	OK	Hang up.

C.2 Data call (CSD mode)

Command sent by DTE (user)	DCE response (module)	Description
AT+CBST=7,0,1	OK	Configure the data call to 9600 RLP analog.
ATD+3930012345678	CONNECT 9600 ~ }#À!}!}1} }4}"& }* } }%}&ú...}<□}'"} (}" /È~~ }#À!}!}2} }4}"& }* } }%}&ú...}<□}'"} ("Áv~ }#À!}!}3} }4}"& }* } }%}&ú...}<□}'"} ("Èâ~ +++ OK	Outgoing data call (+3930012345678 is written here as example).
		Connect to the remote analog modem.
ATH	OK	Hang up.
AT+CBST=71,0,1	OK	Set data call to 9600 RLP V.110 ISDN.
ATD+3930012345678	CONNECT 9600 ~ }#À!}!}!} }4}"& }* } }%}&ú,,Ej}'"} ("KÏ~~ }#À!}!}! }4}"& }* } } }%}&ú,,Ej}'"} (}" "_~~ }#À!}!}ž} }4}"& }* } }%}&ú,,Ej}'"} ("Èâ~ +++ OK	Outgoing data call (+3930012345678 is written here as example).
		Connect to the remote ISDN modem.
ATH	OK	Hang up.

C.3 SMS management

Command sent by DTE (user)	DCE response (module)	Description
AT+CMGF=1	OK	Set the text mode as the format that will be used. To be set before of the first operation.
AT+CMGS="+3930012345678" SMS TEXT MESSAGE 0123456789<CTRL-Z>	> +CMGS: 0 OK	Send the 1 st SMS (+3930012345678 is written here as example).
AT+CMGS="+3930012345678" SMS TEXT MESSAGE 0123456789<CTRL-Z>	> +CMGS: 1 OK	Send the 2 nd SMS (+3930012345678 is written here as example).
AT+CMGL	+CMGL: 302,"REC UNREAD", "+3930012345678", , "05/09/27,16:40:36+08" SMS TEXT MESSAGE 0123456789 OK	List all the incoming SMSes (+3930012345678 is written here as example).

C.4 Internet connection in GPRS mode (using external TCP/IP stack)

Command sent by DTE (user)	DCE response (module)	Description
AT+CGATT?	+CGATT: 1 OK	Check if the cellular module is attached to GPRS service (1 – attached, 0 – detached).
AT+CGDCONT=1,"IP","uni.tim.it"	OK	Define the PDP context parameters.
AT+CGDCONT?	+CGDCONT: 1,"IP","my apn","0.0.0.0",0,0 OK	
ATD*99***1#	CONNECT	Initiate the GPRS connection.
+++	NO CARRIER	Disconnect with +++ sequence.

C.5 Internet connection in GPRS mode (using internal TCP/IP stack)

Command sent by DTE (user)	DCE response (module)	Description
AT+UPSD=0,1,"my apn"	OK	Configure PDP-context parameters. Make sure to have the correct APN.
AT+UPSD=0,2,"my user-name"	OK	Username and password depend on the mobile operator used. In most cases these are not required. Simply use space or omit these commands.
AT+UPSD=0,3,"my password"	OK	
AT+UPSD=0	(configuration parameters)	Check the configuration.
AT+UPSDA=0,1	OK	Store configuration in non-volatile memory (NVM).
AT+UPSDA=0,3	OK	Activate the PDP context.

Verify connection and PDP-context:

Command sent by DTE (user)	DCE response (module)	Description
AT+UPSND=0,0	(IP address)	Check IP addresses assigned.
AT+UPSND=0,1	(IP address of DNS)	Check DNS assigned.
AT+UDNSRN=0,"www.u-blox.com"	195.34.89.137 or 195.34.89.138 OK	Example: resolve DNS name.

C.6 Enable communication between cellular and GNSS modules

Command sent by DTE (user)	DCE response (module)	Description
AT+UGPS=1,0	OK	Enable communication. On the ADP-GNSS: LED DS118 lights green, LED DS132 blinks.

C.7 Read NMEA messages (example: GLL)

Several NMEA messages via Cellular USB or UART can be read. The example below shows how to read a GLL message to get the last available Geographic position Latitude / Longitude. For the full list of NMEA messages that can be read, see the u-blox AT commands manual [1].

Command sent by DTE (user)	DCE response (module)	Description
AT+UGGLL=1	OK	Enable the GLL message.
AT+UGGLL?	+UGGLL: (state), (GLL-msg) OK Or +UGGLL: (state), Not Available OK	Read the message. The last available GLL message is displayed.

C.8 GNSS AssistNow

GNSS AssistNow Online:

Command sent by DTE (user)	DCE response (module)	Description
AT+UGAOP="agps.u-blox.com",46434,1000,0	OK	Insert server data - the parameters are written as an example.
AT+UPSD=0,1,"web.omnitel.it"	OK	Configure the GPRS connection - "web.omnitel.it" is written as APN example.
AT+UGPS=1,4	OK	Start the GNSS. No need to do this if this is already done before.
AT+UGAOS=4	OK	Send data to the u-blox server.

GNSS AssistNow Offline:

Command sent by DTE (user)	DCE response (module)	Description
AT+UGAOF="http://alp.u-blox.com/current_14d.alp",0,1,3	OK	Insert server data - the parameters are written as an example.
AT+UGPS=1,2	OK	Start the GNSS (the default interface is LDC).

Declaration of conformities

The equipment is intended for indoor usage. It is the user's duty to verify if further restrictions apply, such as when used in airplanes, hospitals or hazardous locations (petrol stations, refineries...).

Any changes or modification made to this equipment will void its compliance to the safety requirements.

Maintenance, inspections and/or reparations of the EVK-U2x shall be performed by u-blox AG.

Hereby, u-blox AG declares that this EVK-U2x is in compliance with the essential requirements and other relevant provisions of Directive 1999/5/EC.

Related documents

- [1] u-blox AT Commands Manual, Docu No UBX-13002752
- [2] u-blox LISA-U2 series Data Sheet, Docu No UBX-13001734
- [3] u-blox LISA-U series System Integration Manual, Docu No UBX-13001118
- [4] u-blox m-center User Guide, Docu No UBX-13001925
- [5] u-blox EVK-U2x Quick Start, Docu No UBX-14002546

All these documents are available on our homepage (www.u-blox.com)



For regular updates to u-blox documentation and to receive product change notifications, please register on our homepage (www.u-blox.com).

Revision history

Revision	Date	Name	Status / Comments
-	02-Jan-2012	lpah	Initial Release
1	25-Jun-2012	lpah	Extended to support EVK-U23
2	20-Nov-2012	lpah	Added declaration of conformities (Last revision with old doc number, 3G.G3-EK-11002)
A	08-Aug-2013	lpah	Updated USB ports description
A1	28-Aug-2013	smos	Added note that EVK-U20 can be used to evaluate other LISA-U2 series modules
R06	29-Jul-2015	sses	Updated EVK-U2x description including EVB-WL3 instead of EVB-WL1

Contact

For complete contact information visit us at www.u-blox.com

u-blox Offices

North, Central and South America

u-blox America, Inc.

Phone: +1 703 483 3180
E-mail: info_us@u-blox.com

Regional Office West Coast:

Phone: +1 408 573 3640
E-mail: info_us@u-blox.com

Technical Support:

Phone: +1 703 483 3185
E-mail: support_us@u-blox.com

Headquarters Europe, Middle East, Africa

u-blox AG

Phone: +41 44 722 74 44
E-mail: info@u-blox.com
Support: support@u-blox.com

Asia, Australia, Pacific

u-blox Singapore Pte. Ltd.

Phone: +65 6734 3811
E-mail: info_ap@u-blox.com
Support: support_ap@u-blox.com

Regional Office Australia:

Phone: +61 2 8448 2016
E-mail: info_anz@u-blox.com
Support: support_ap@u-blox.com

Regional Office China (Beijing):

Phone: +86 10 68 133 545
E-mail: info_cn@u-blox.com
Support: support_cn@u-blox.com

Regional Office China (Shenzhen):

Phone: +86 755 8627 1083
E-mail: info_cn@u-blox.com
Support: support_cn@u-blox.com

Regional Office India:

Phone: +91 959 1302 450
E-mail: info_in@u-blox.com
Support: support_in@u-blox.com

Regional Office Japan:

Phone: +81 3 5775 3850
E-mail: info_jp@u-blox.com
Support: support_jp@u-blox.com

Regional Office Korea:

Phone: +82 2 542 0861
E-mail: info_kr@u-blox.com
Support: support_kr@u-blox.com

Regional Office Taiwan:

Phone: +886 2 2657 1090
E-mail: info_tw@u-blox.com
Support: support_tw@u-blox.com