

16 A - 800 V - 150 °C 8H Triac in TO-220AB insulated

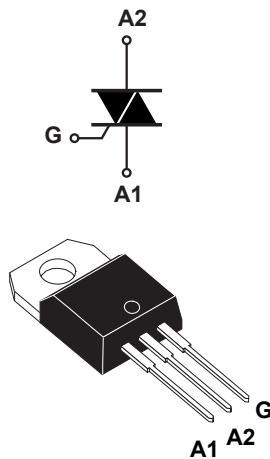

TO-220AB insulated

Features

- 16 A medium current Triac
- 800 V symmetrical blocking voltage
- 150 °C maximum junction temperature T_j
- Three triggering quadrants
- High noise immunity - static dV/dt
- Robust dynamic turn-off commutation - $(di/dt)_c$
- ECOPACK2 compliant component
- Molding resin UL94-V0 flammability certified
- UL recognized for insulation , UL1557: 2.5 kV
 - Reference file: E81734

Applications

- General purpose AC line load control
- AC induction and universal motor control
- Lighting and automation I/O control
- Water heater, room heater and coffee machine
- Home automation smart AC plug
- Inrush current limiter in AC DC rectifiers

Description

Specifically designed to operate at 800 V and 150 °C, the **T1635H-8I** Triac housed in TO-220AB insulated provides an enhanced thermal management: this 16 A Triac is the right choice for a compact drive of AC loads and enables the heatsink size reduction.

Based on the ST high temperature Snubberless technology, it offers higher specified turn off commutation and noise immunity levels up to the T_j max.

Snubberless is a trademark of STMicroelectronics.

The **T1635H-8I** safely optimizes the control of the motors and heaters loads for the most constraining environments of home appliances and industrial control.

By using an internal ceramic pad, it provides a recognized voltage insulation, rated at 2500 V_{RMS} .

Product status link

[T1635H-8I](#)

Product summary

| | |
|-------------------|--------|
| $I_{T(RMS)}$ | 16 A |
| V_{DRM}/V_{RRM} | 800 V |
| V_{DSM}/V_{RSM} | 900 V |
| I_{GT} | 35 mA |
| T_j max. | 150 °C |

1 Characteristics

Table 1. Absolute maximum ratings (limiting values)

| Symbol | Parameter | Value | Unit |
|-------------------|---|---|-------------------------|
| $I_{T(RMS)}$ | RMS on-state current (full sine wave) | $T_c = 115\text{ °C}$ | 16 A |
| I_{TSM} | Non repetitive surge peak on-state current (full cycle, T_j initial = 25 °C) | $t = 16.7\text{ ms}$ | 168 |
| | | $t = 20\text{ ms}$ | 160 |
| I^2t | I^2t value for fusing | $t_p = 10\text{ ms}$ | 169 A ² s |
| di/dt | Critical rate of rise of on-state current, $I_G = 2 \times I_{GT}$, $t_r \leq 100\text{ ns}$, $f = 100\text{ Hz}$ | $T_j = 25\text{ °C}$ | 100 A/ μ s |
| V_{DRM}/V_{RRM} | Repetitive peak off-state voltage | | 800 V |
| V_{DSM}/V_{RSM} | Non Repetitive peak off-state voltage | $t_p = 10\text{ ms}$, $T_j = 25\text{ °C}$ | 900 V |
| I_{GM} | Peak gate current | $t_p = 20\text{ }\mu\text{s}$, $T_j = 150\text{ °C}$ | 4 A |
| P_{GM} | Maximum gate power dissipation | | 5 W |
| $P_{G(AV)}$ | Average gate power dissipation | $T_j = 150\text{ °C}$ | 1 W |
| T_{stg} | Storage temperature range | | -40 to +150 °C |
| T_j | Operating junction temperature range | | -40 to +150 °C |
| T_L | Maximum lead temperature for soldering during 10 s | | 260 °C |
| V_{INS} | Insulation RMS voltage, 1 minute | | 2.5 kV |

Table 2. Electrical characteristics ($T_j = 25\text{ °C}$, unless otherwise specified)

| Symbol | Test conditions | Quadrants | Value | Unit |
|-------------------|--|-----------------------|-------|--------------------|
| I_{GT} | $V_D = 12\text{ V}$, $R_L = 30\text{ }\Omega$ | I - II - III | Min. | 5 mA |
| | | | Max. | 35 mA |
| V_{GT} | $V_D = 12\text{ V}$, $R_L = 30\text{ }\Omega$ | I - II - III | Max. | 1.3 V |
| V_{GD} | $V_D = V_{DRM}$, $R_L = 3.3\text{ k}\Omega$ | I - II - III | Min. | 0.15 V |
| | $T_j = 150\text{ °C}$ | | | |
| I_L | $I_G = 1.2 \times I_{GT}$ | I - III | Max. | 50 mA |
| | | II | Max. | 80 mA |
| $I_H^{(1)}$ | $I_T = 500\text{ mA}$, gate open | | Max. | 35 mA |
| $dV/dt^{(1)}$ | $V_D = 536\text{ V}$, gate open | $T_j = 150\text{ °C}$ | Min. | 2000 V/ μ s |
| $(di/dt)_c^{(1)}$ | Without snubber network | $T_j = 150\text{ °C}$ | Min. | 16 A/ms |

1. For both polarities of A2 referenced to A1.

Table 3. Static characteristics

| Symbol | Test conditions | T_j | | Value | Unit |
|-------------------|---|--------|------|-------|------|
| $V_{TM}^{(1)}$ | $I_{TM} = 22\text{ A}$, $t_p = 380\ \mu\text{s}$ | 25 °C | Max. | 1.50 | V |
| $V_{TO}^{(1)}$ | Threshold voltage | 150 °C | Max. | 0.80 | V |
| $R_D^{(1)}$ | Dynamic resistance | 150 °C | Max. | 23 | mΩ |
| I_{DRM}/I_{RRM} | $V_D = V_R = V_{DRM} = V_{RRM}$ | 25 °C | Max. | 2.0 | μA |
| | | 150 °C | | 5.5 | mA |
| | $V_D = V_R = 400\text{ V}$, peak voltage | 150 °C | Max. | 2.3 | mA |

1. For both polarities of A2 referenced to A1.

Table 4. Thermal resistance

| Symbol | Parameter | | Value | Unit |
|---------------|-----------------------|------|-------|------|
| $R_{th(j-c)}$ | Junction to case (AC) | Max. | 2.0 | °C/W |
| $R_{th(j-a)}$ | Junction to ambient | Typ. | 60 | °C/W |

1.1 Characteristics (curves)

Figure 1. Maximum power dissipation versus on-state RMS current

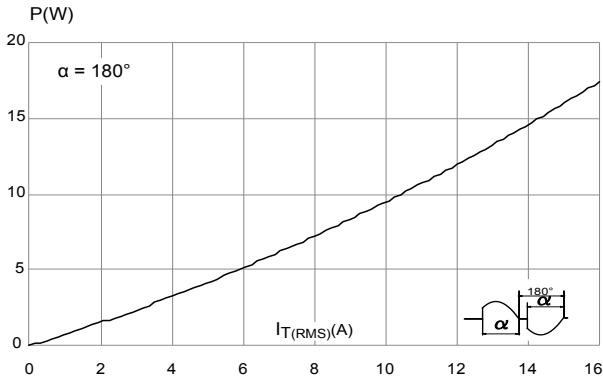

Figure 2. On-state RMS current versus case temperature

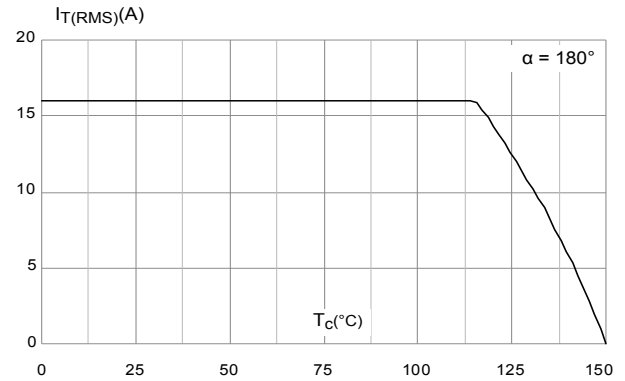

Figure 3. On-state RMS current versus ambient temperature (free air convection)

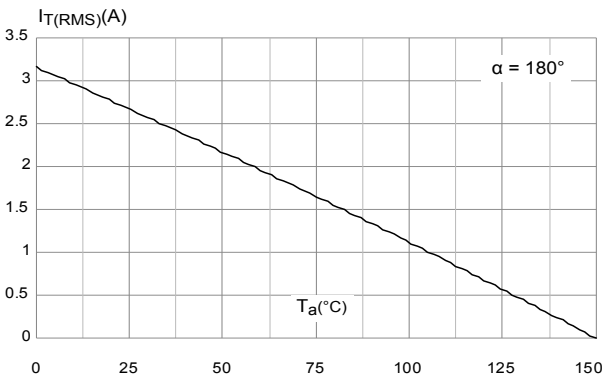

Figure 4. On-state characteristics (maximum values)

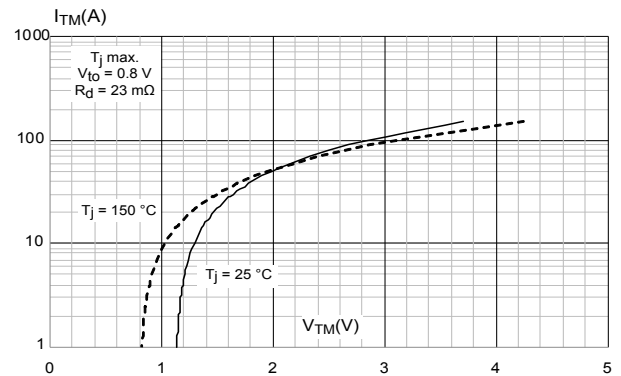

Figure 5. Relative variation of thermal impedance versus pulse duration

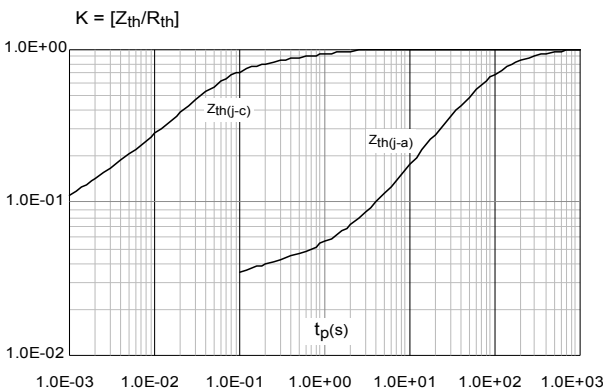

Figure 6. Recommended maximum case-to-ambient thermal resistance versus ambient temperature for different peak off-state voltages

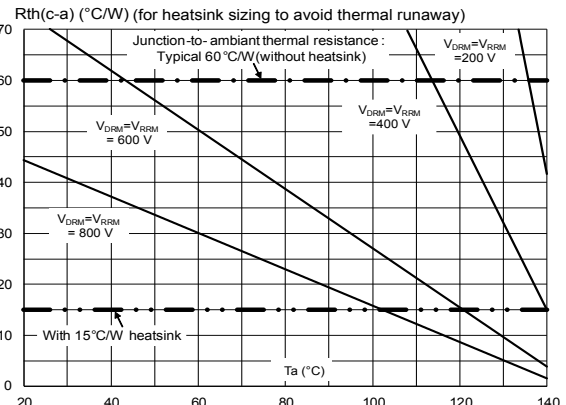

Figure 7. Relative variation of gate trigger voltage and current versus junction temperature (typical values)

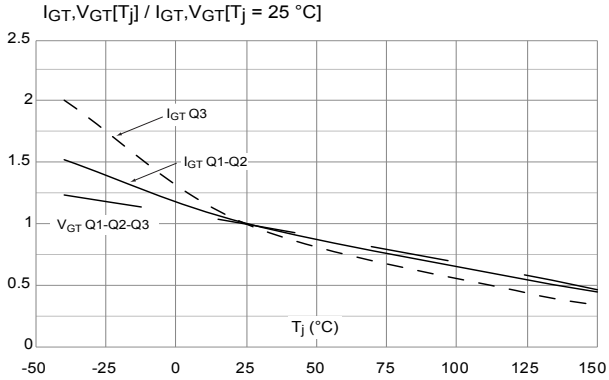

Figure 8. Relative variation of holding current and latching current versus junction temperature (typical values)

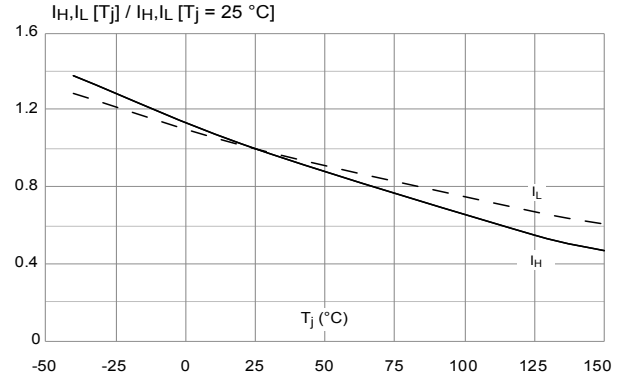

Figure 9. Surge peak on-state current versus number of cycles

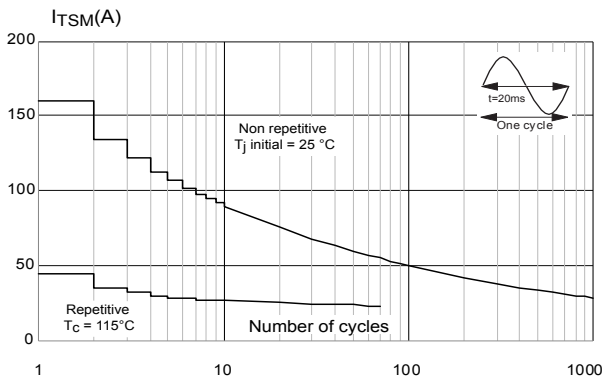

Figure 10. Non repetitive surge peak on-state current for a sinusoidal pulse with width $t_p < 10$ ms

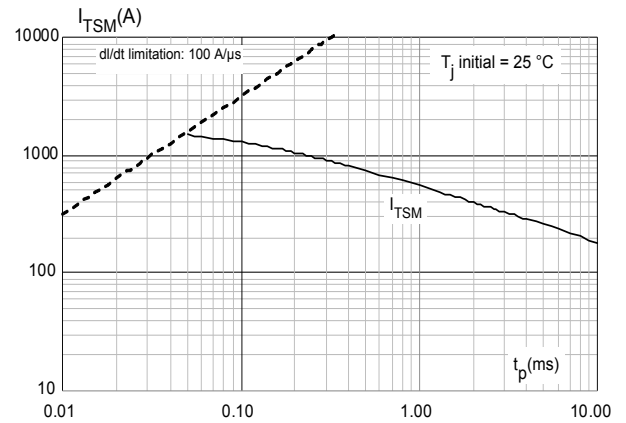

Figure 11. Relative variation of static dV/dt immunity versus junction temperature

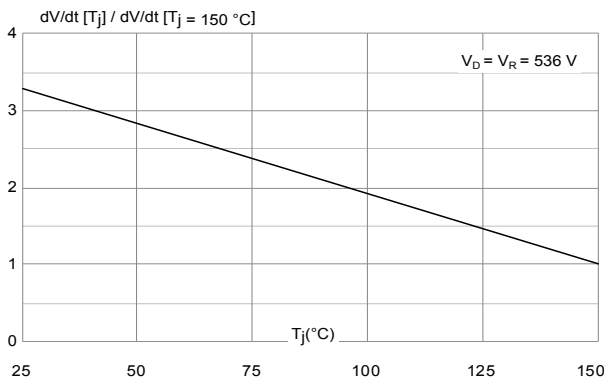

Figure 12. Relative variation of critical rate of decrease of main current versus junction temperature

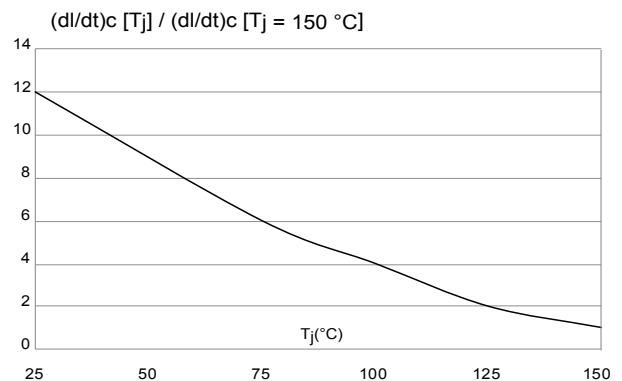
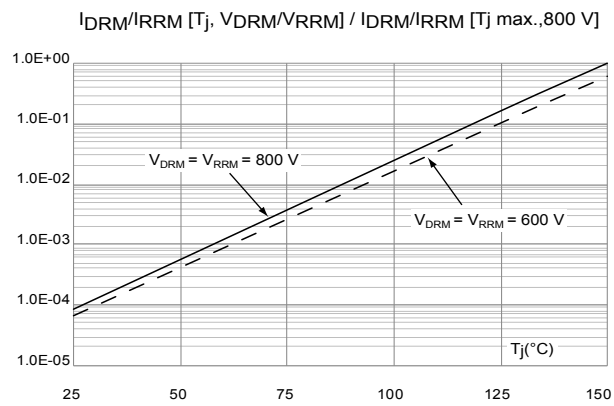

Figure 13. Relative variation of leakage current versus junction temperature for different values of blocking voltage



2 Package information

In order to meet environmental requirements, ST offers these devices in different grades of **ECOPACK** packages, depending on their level of environmental compliance. ECOPACK specifications, grade definitions and product status are available at: www.st.com. ECOPACK is an ST trademark.

2.1 TO-220AB insulated package information

- Molding compound resin is halogen free and meets UL94 flammability standard, level V0
- Lead-free plating package leads
- Recommended torque: 0.4 to 0.6 N·m

Figure 14. TO-220AB package outline

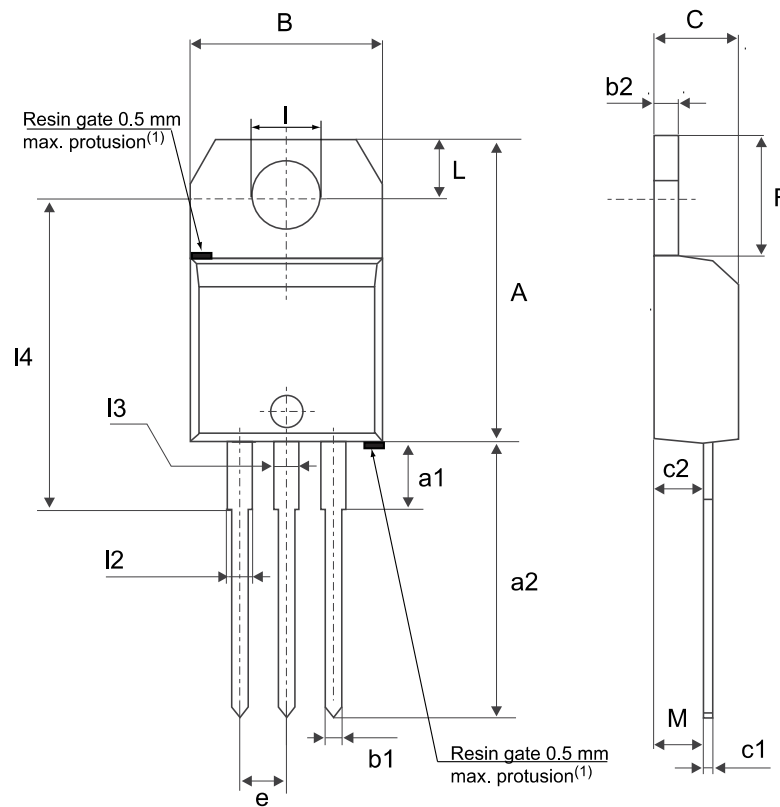

(1)Resin gate position accepted in one of the two positions or in the symmetrical opposites.

Table 5. TO-220AB package mechanical data

| Ref. | Dimensions | | | | | |
|------|-------------|-------|-------|-----------------------|--------|--------|
| | Millimeters | | | Inches ⁽¹⁾ | | |
| | Min. | Typ. | Max. | Min. | Typ. | Max. |
| A | 15.20 | | 15.90 | 0.5984 | | 0.6260 |
| a1 | | 3.75 | | | 0.1476 | |
| a2 | 13.00 | | 14.00 | 0.5118 | | 0.5512 |
| B | 10.00 | | 10.40 | 0.3937 | | 0.4094 |
| b1 | 0.61 | | 0.88 | 0.0240 | | 0.0346 |
| b2 | 1.23 | | 1.32 | 0.0484 | | 0.0520 |
| C | 4.40 | | 4.60 | 0.1732 | | 0.1811 |
| c1 | 0.49 | | 0.70 | 0.0193 | | 0.0276 |
| c2 | 2.40 | | 2.72 | 0.0945 | | 0.1071 |
| e | 2.40 | | 2.70 | 0.0945 | | 0.1063 |
| F | 6.20 | | 6.60 | 0.2441 | | 0.2598 |
| I | 3.73 | | 3.88 | 0.1469 | | 0.1528 |
| L | 2.65 | | 2.95 | 0.1043 | | 0.1161 |
| I2 | 1.14 | | 1.70 | 0.0449 | | 0.0669 |
| I3 | 1.14 | | 1.70 | 0.0449 | | 0.0669 |
| I4 | 15.80 | 16.40 | 16.80 | 0.6220 | 0.6457 | 0.6614 |
| M | | 2.6 | | | 0.1024 | |

1. Inch dimensions are for reference only.

3 Ordering information

Figure 15. Ordering information scheme

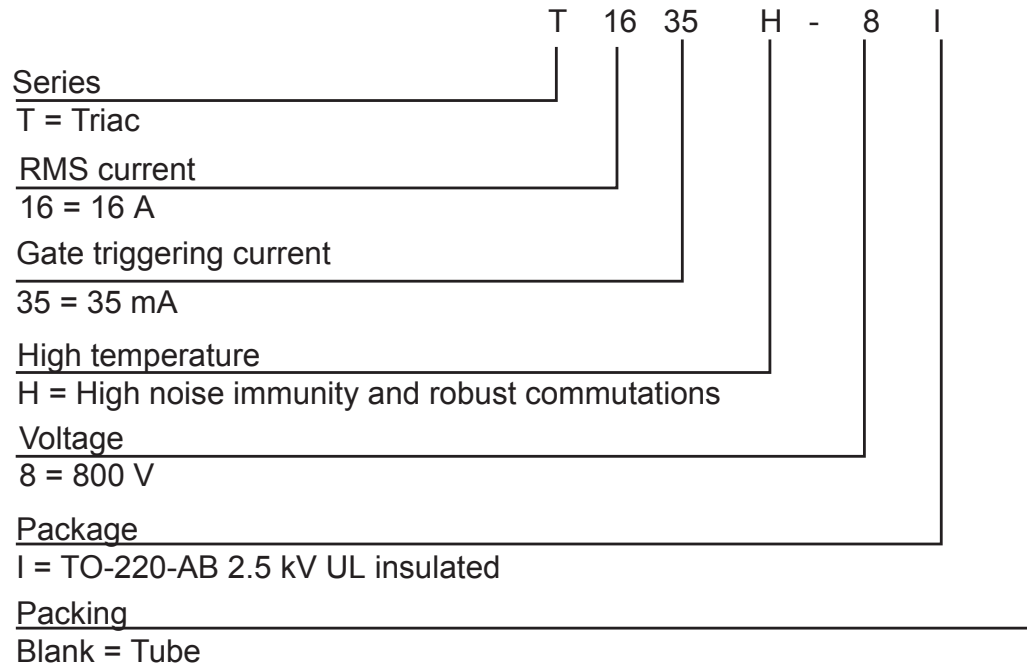

Table 6. Ordering information

| Order code | Marking | Package | Weight | Base qty. | Delivery mode |
|------------|-----------|---------------|--------|-----------|---------------|
| T1635H-8I | T1635H-8I | TO-220AB Ins. | 2.3 g | 50 | Tube |

Revision history

Table 7. Document revision history

| Date | Version | Changes |
|-------------|---------|------------------------------|
| 27-Jan-2020 | 1 | Initial release. |
| 21-Dec-2020 | 2 | Updated general description. |

IMPORTANT NOTICE – PLEASE READ CAREFULLY

STMicroelectronics NV and its subsidiaries (“ST”) reserve the right to make changes, corrections, enhancements, modifications, and improvements to ST products and/or to this document at any time without notice. Purchasers should obtain the latest relevant information on ST products before placing orders. ST products are sold pursuant to ST’s terms and conditions of sale in place at the time of order acknowledgement.

Purchasers are solely responsible for the choice, selection, and use of ST products and ST assumes no liability for application assistance or the design of Purchasers’ products.

No license, express or implied, to any intellectual property right is granted by ST herein.

Resale of ST products with provisions different from the information set forth herein shall void any warranty granted by ST for such product.

ST and the ST logo are trademarks of ST. For additional information about ST trademarks, please refer to www.st.com/trademarks. All other product or service names are the property of their respective owners.

Information in this document supersedes and replaces information previously supplied in any prior versions of this document.

© 2020 STMicroelectronics – All rights reserved