

# Data sheet | Item number: 788-608

Relay module; Nominal input voltage: 230 VAC; 1 changeover contact;  
Limiting continuous current: 16 A; with gold contacts; Red status indicator;  
Module width: 15 mm; 2,50 mm<sup>2</sup>; gray

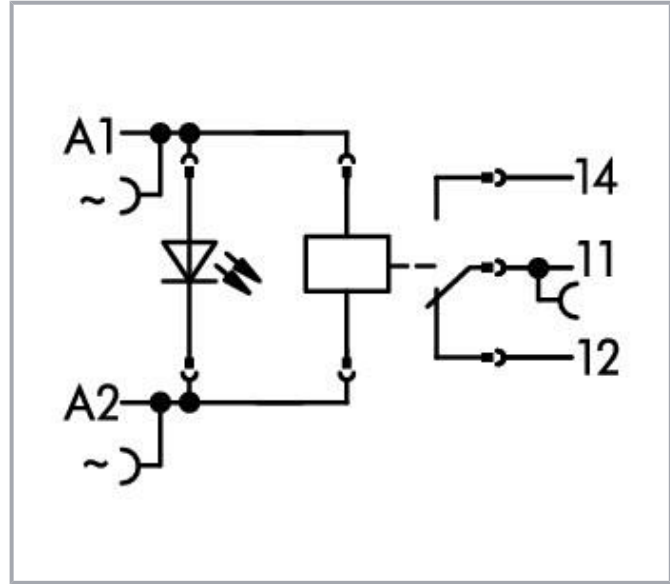

[www.wago.com/788-608](http://www.wago.com/788-608)

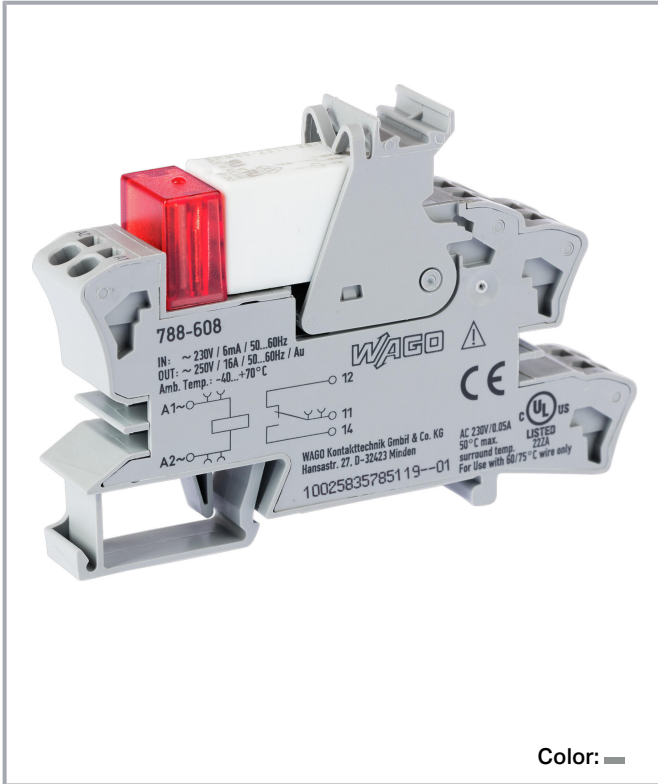

Color: —

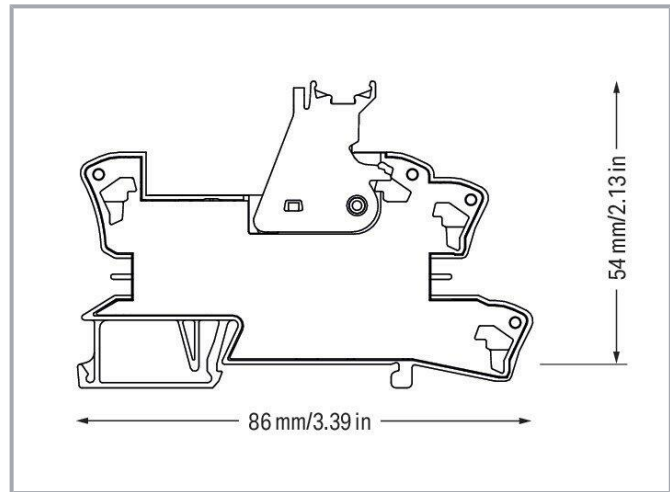
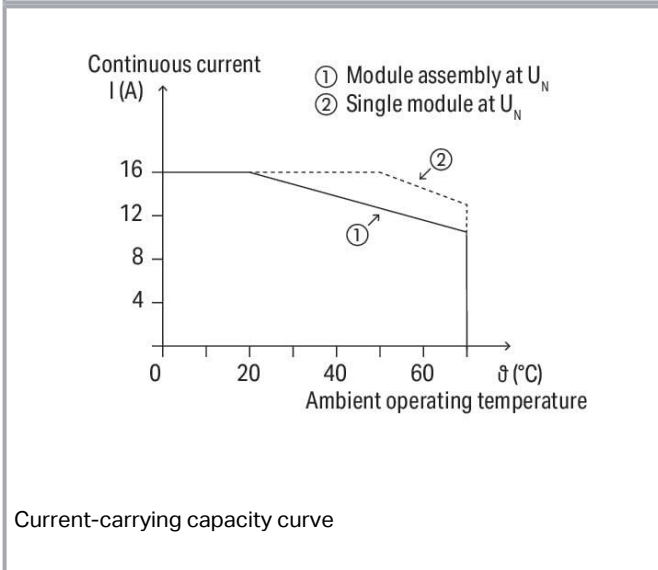

Subject to changes. Please also observe the further product documentation!

WAGO GmbH & Co. KG  
Hansastr. 27  
32423 Minden  
Phone: +49571 887-0 | Fax: +49571 887-169  
Email: [info.de@wago.com](mailto:info.de@wago.com) | Web: [www.wago.com](http://www.wago.com)

Do you have any questions about our products?  
We are always happy to take your call at +49 (571) 887-44222.

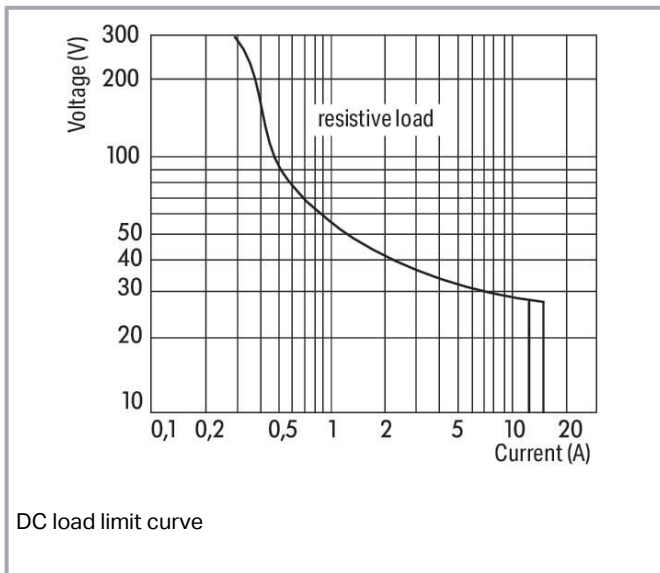

## Data

### Notes

Safety information

A separator plate (e.g., 209-191) must be used for voltages greater than 250 V between adjacent relay modules and for compliance with the reinforced insulation requirements.

Note

- Reinforced insulation between coil and contacts
- To prevent damaging the gold layer, 30 VDC switching voltages and 50 mA currents must not be exceeded. Higher switching power eventually evaporates the gold layer. The resulting deposits in the housing may reduce service life.
- To protect the relay coils and contacts, inductive loads must be dampened with an effective protection circuit.

## Technical data

### Control Circuit

Nominal input voltage $U_N$	AC 230 V
Input voltage range	$\pm 10\%$
Nominal input current at $U_N$	5 mA

Subject to changes. Please also observe the further product documentation!

## Load circuit

Number of changeover/switchover contacts	1
Contact material (relay)	AgNi + Au
Limiting continuous current	16 A
Switching voltage (max.)	AC 250 V
Switching power (resistive) max.	AC 4000 VA; DC (see load limit curve)
Switching capacity	AC-15: 6 A / AC 250 V; DC-13: 2 A / DC 24 V
Recommended minimum load	5 V / 2 mA / 50 mW
Pull-in time (typ.)	7 ms
Drop-out time (typ.)	3 ms
Bounce time (typ.)	6 ms
Electrical life (NO; resistive load; 23 °C)	70 x 10 <sup>3</sup> switching operations
Mechanical life	30 x 10 <sup>6</sup> switching operations
Switching frequency with/without load (max.)	10 min <sup>-1</sup> / 1200 min <sup>-1</sup>

## Signaling

Status indicator	Red LED
------------------	---------

## Safety and protection

Rated voltage	250 V
Rated surge voltage	4 kV
Pollution degree	3
Dielectric strength (control/load circuit) (AC, 1 min)	5 kVrms
Dielectric strength (open contact) (AC, 1 min)	1 kVrms
Safety information	A separator plate (e.g., 209-191) must be used for voltages greater than 250 V between adjacent relay modules and for compliance with the reinforced insulation requirements.
Protection type	IP20

## Connection data

Connection technology	Push-in CAGE CLAMP®
Solid conductor	0.34 ... 2.5 mm <sup>2</sup> / 22 ... 14 AWG
Fine-stranded conductor	0.34 ... 2.5 mm <sup>2</sup> / 22 ... 14 AWG
Strip length	9 ... 10 mm / 0.35 ... 0.39 inches

Subject to changes. Please also observe the further product documentation!



## Physical data

Width	15 mm / 0.591 inches
Height	86 mm / 3.386 inches
Depth from upper-edge of DIN-rail	54 mm / 2.126 inches

## Mechanical data

Mounting type	DIN-35 rail
---------------	-------------

## Material Data

Color	gray
Fire load	0.877 MJ
Weight	47.8 g

## Environmental requirements

Ambient temperature (operation at $U_N$ )	-40 ... +70 °C
Ambient temperature UL (operation at $U_N$ )	-40 ... +50 °C
Ambient temperature (storage)	-40 ... +70 °C
Processing temperature	-25 ... +50 °C
Temperature range of connection cable	$\geq (T_{\text{ambient}} + 20 \text{ K})$

## Standards and specifications

Standards/specifications	EN 61010-2-201 EN 61810-1 EN 61373 UL 508 DNV
--------------------------	---

## Basic relay

WAGO Basic Relay	788-179
------------------	---------

## Commercial data

Product Group	6 (INTERFACE ELECTRONIC)
eCl@ss 10.0	27-37-16-01
eCl@ss 9.0	27-37-16-01

Subject to changes. Please also observe the further product documentation!

ETIM 8.0	EC001437
ETIM 7.0	EC001437
PU (SPU)	20 (1) pcs
Packaging type	box
Country of origin	DE
GTIN	4055143998055
Customs tariff number	85364900990

## Environmental Product Compliance

RoHS Compliance Status	Compliant, No Exemption
------------------------	-------------------------

## Approvals / Certificates

### General approvals

Logo	Approval	Additional Approval Text	Certificate name
	EAC Brjansker Zertifizierungsstelle	TP TC 004/2011	EAC RU C-DE.AM02.B.00122 /19

### Declarations of conformity and manufacturer's declarations

Logo	Approval	Additional Approval Text	Certificate name
	EU-Declaration of Conformity WAGO GmbH & Co. KG	-	-

### Approvals for marine applications

Logo	Approval	Additional Approval Text	Certificate name
	DNV DNV Germany GmbH	DNV-CG-0339, Aug. 2021	TAA00001D1
	PRS Polski Rejestr Statków	-	TE/2186 /880590/18

Subject to changes. Please also observe the further product documentation!

WAGO GmbH & Co. KG  
Hansastr. 27  
32423 Minden  
Phone: +49571 887-0 | Fax: +49571 887-169  
Email: [info.de@wago.com](mailto:info.de@wago.com) | Web: [www.wago.com](http://www.wago.com)

Do you have any questions about our products?  
We are always happy to take your call at +49 (571) 887-44222.

## Optional accessories

### Tool

Operating tool



**Item no.: 210-720**

Operating tool; Blade: 3.5 x 0.5 mm; with a partially insulated shaft; multicoloured

[www.wago.com/210-720](http://www.wago.com/210-720)

### Filter Module

Suppressor module



**Item no.: 788-148**

Filter module; RC filter element; Nominal voltage: 230 VAC

[www.wago.com/788-148](http://www.wago.com/788-148)

### Jumpers

Jumper



**Item no.: 788-116**

Jumper; for jumper slot; 6-way; insulated; light gray

[www.wago.com/788-116](http://www.wago.com/788-116)



**Item no.: 788-117**

Jumper; for jumper slot; 8-way; insulated; light gray

[www.wago.com/788-117](http://www.wago.com/788-117)



**Item no.: 788-114**

Jumper; for jumper slot; 3-way; insulated; light gray

[www.wago.com/788-114](http://www.wago.com/788-114)



**Item no.: 788-113**

Jumper; for jumper slot; 2-way; insulated; light gray

[www.wago.com/788-113](http://www.wago.com/788-113)



**Item no.: 788-115**

Jumper; for jumper slot; 4-way; insulated; light gray

[www.wago.com/788-115](http://www.wago.com/788-115)



**Item no.: 859-402**

Jumper; for jumper slot; 2-way; insulated; light gray

[www.wago.com/859-402](http://www.wago.com/859-402)



**Item no.: 788-118**

Jumper; for jumper slot; 2-way; from 1 to 3; insulated; light gray

[www.wago.com/788-118](http://www.wago.com/788-118)

### Basic Relay

Basic relay



**Item no.: 788-179**

Basic relay; Nominal input voltage: 230 VAC; 1 changeover contact; Limiting continuous current: 16 A; with gold contacts; Module width: 13 mm; Module height: 15 mm

[www.wago.com/788-179](http://www.wago.com/788-179)

### Ferrule

Ferrule



**Item no.: 216-241**

Ferrule; Sleeve for 0.5 mm<sup>2</sup> / 20 AWG; insulated; electro-tin plated; electrolytic copper; gastight crimped; acc. to DIN 46228, Part 4/09.90; white

[www.wago.com/216-241](http://www.wago.com/216-241)

**Item no.: 216-242**

Subject to changes. Please also observe the further product documentation!

WAGO GmbH & Co. KG

Hansastr. 27













32423 Minden

Phone: +49571 887-0 | Fax: +49571 887-169







Email: [info.de@wago.com](mailto:info.de@wago.com) | Web: [www.wago.com](http://www.wago.com)

Do you have any questions about our products?

We are always happy to take your call at +49 (571) 887-44222.

	Ferrule; Sleeve for 0.75 mm <sup>2</sup> / 18 AWG; insulated; electro-tin plated; electrolytic copper; gastight crimped; acc. to DIN 46228, Part 4/09.90; gray	<a href="http://www.wago.com/216-242">www.wago.com/216-242</a>
	<b>Item no.: 216-243</b> Ferrule; Sleeve for 1 mm <sup>2</sup> / AWG 18; insulated; electro-tin plated; electrolytic copper; gastight crimped; acc. to DIN 46228, Part 4/09.90; red	<a href="http://www.wago.com/216-243">www.wago.com/216-243</a>
	<b>Item no.: 216-244</b> Ferrule; Sleeve for 1.5 mm <sup>2</sup> / AWG 16; insulated; electro-tin plated; electrolytic copper; gastight crimped; acc. to DIN 46228, Part 4/09.90; black	<a href="http://www.wago.com/216-244">www.wago.com/216-244</a>
 <small>image coming soon</small>	<b>Item no.: 216-542</b> Twin ferrule; Sleeve for 2 x 1 mm <sup>2</sup> / AWG 2 x 18; red, insulated; 12 mm long; red	<a href="http://www.wago.com/216-542">www.wago.com/216-542</a>
<b>Indicators</b>		
Status indication		
	<b>Item no.: 788-125</b> Accessories for relay modules; Operation status indicator: red	<a href="http://www.wago.com/788-125">www.wago.com/788-125</a>
<b>Marking accessories</b>		
Marking strip		
	<b>Item no.: 2009-110</b> Marking strips; for Smart Printer; on reel; not stretchable; plain; snap-on type; white	<a href="http://www.wago.com/2009-110">www.wago.com/2009-110</a>
Double marker carrier		
	<b>Item no.: 209-128</b> Adaptor; gray	<a href="http://www.wago.com/209-128">www.wago.com/209-128</a>
Marking devices		
	<b>Item no.: 210-110</b> Fiber-tip pen	<a href="http://www.wago.com/210-110">www.wago.com/210-110</a>
Protective marker cover		
	<b>Item no.: 209-184</b> Protection cover; transparent	<a href="http://www.wago.com/209-184">www.wago.com/209-184</a>
Marker		
	<b>Item no.: 2009-115</b> WMB-Inline; for Smart Printer; 1500 pieces on roll; stretchable 5 - 5.2 mm; plain; snap-on type; white	<a href="http://www.wago.com/2009-115">www.wago.com/2009-115</a>
	<b>Item no.: 209-183</b> Marker; white	<a href="http://www.wago.com/209-183">www.wago.com/209-183</a>
	<b>Item no.: 793-501</b> WMB marking card; as card; not stretchable; plain; snap-on type; white	<a href="http://www.wago.com/793-501">www.wago.com/793-501</a>

Subject to changes. Please also observe the further product documentation!

	<b>Item no.: 793-502</b> WMB marking card; as card; MARKED; 1 ... 10 (10x); not stretchable; Horizontal marking; snap-on type; <a href="http://www.wago.com/793-502">www.wago.com/793-502</a> white
	<b>Item no.: 793-503</b> WMB marking card; as card; MARKED; 11 ... 20 (10x); not stretchable; Horizontal marking; snap-on type; <a href="http://www.wago.com/793-503">www.wago.com/793-503</a> white
	<b>Item no.: 793-504</b> WMB marking card; as card; MARKED; 21 ... 30 (10x); not stretchable; Horizontal marking; snap-on type; <a href="http://www.wago.com/793-504">www.wago.com/793-504</a> white
	<b>Item no.: 793-505</b> WMB marking card; as card; MARKED; 31 ... 40 (10x); not stretchable; Horizontal marking; snap-on type; <a href="http://www.wago.com/793-505">www.wago.com/793-505</a> white
Group marker carrier	
	<b>Item no.: 209-145</b> Group marker carrier; white <a href="http://www.wago.com/209-145">www.wago.com/209-145</a>
	<b>Item no.: 249-105</b> Group marker carrier; gray <a href="http://www.wago.com/249-105">www.wago.com/249-105</a>

## Downloads

### Documentation

#### Bid Text

788-608 X81 - Datei	2019 Feb 19	xml 5.0 kB	Download
788-608 docx - Datei	2019 Jan 25	docx 17.3 kB	Download

#### Instruction Leaflet

Sockets with Elementary Relay/ SSR	V 1.0.1 2020 Oct 9	pdf 2.3 MB	Download
------------------------------------	-----------------------	---------------	----------

#### Additional Information

Disposal and Recycling Electrical and electronic equipment, Batteries, Packaging	V 1.1.0 2022 Aug 18	pdf 2.2 MB	Download
---	------------------------	---------------	----------

## CAD/CAE-Data

### CAE data

Subject to changes. Please also observe the further product documentation!



EPLAN Data Portal 788-608	<a href="#">URL</a>	<a href="#">Download</a>
WSCAD Universe 788-608	<a href="#">URL</a>	<a href="#">Download</a>
ZUKEN Portal 788-608	<a href="#">URL</a>	<a href="#">Download</a>
<b>CAD data</b>		
2D/3D Models 788-608	<a href="#">URL</a>	<a href="#">Download</a>

## Environmental Product Compliance

### Compliance Search

Environmental Product Compliance 788-608	<a href="#">URL</a>	<a href="#">Download</a>
--	---------------------	--------------------------

Relay module; Nominal input voltage: 230 VAC; 1 changeover contact; Limiting continuous current: 16 A; with gold contacts; Red status indicator; Module width: 15 mm; 2,50 mm<sup>2</sup>; gray

## Installation Notes

### Conductor termination

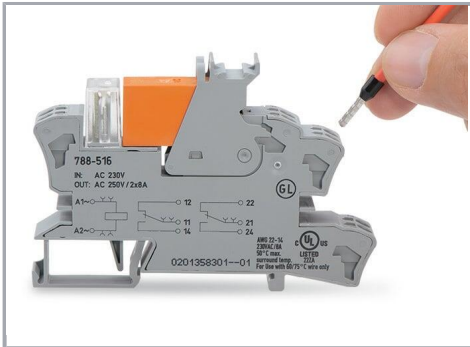

### Conductor termination

### Commoning

Subject to changes. Please also observe the further product documentation!

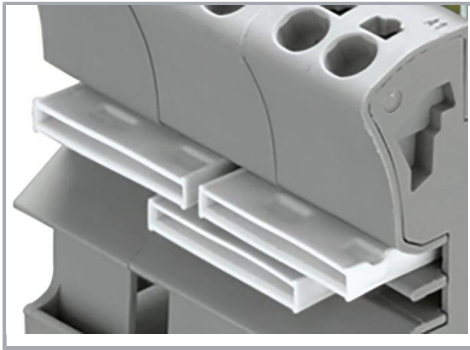

Easy commoning using adjacent jumpers

### Marking

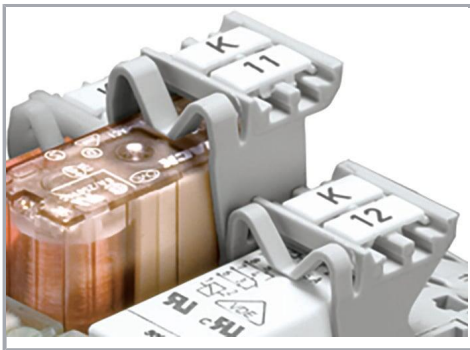

Marking using WMB Multi markers and group marker carriers.

Subject to changes. Please also observe the further product documentation!