

TDK μ POL™ Evaluation Boards Summary

Products: FS1406, FS1404, FS1403 and I2C Programming Dongle

Each evaluation board contains a users design guide for general operation and specifications for typical use case, PCB board design, Build of Materials, schematics, start up and fault condition test, DC/AC and ripple performance, efficiency and losses, and load regulation. Thermal performance evaluation is also provided.

Three standard evaluation boards are shown for the FS1406, FS1404 & FS1403 to show a full 10W to 15W performance rating, respectively --- Best Power Module for Current Density and Performance.

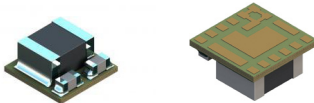
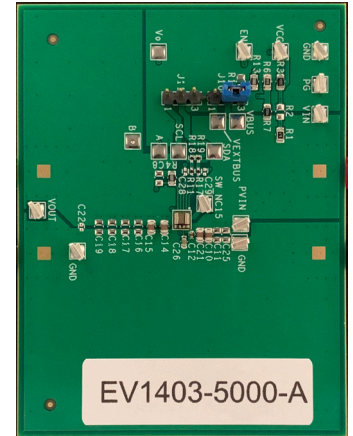
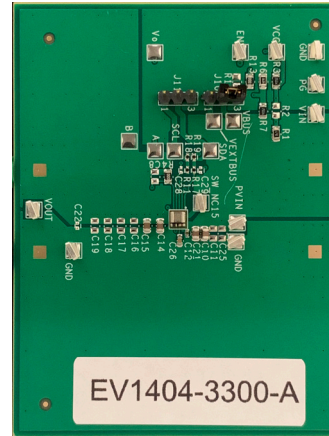
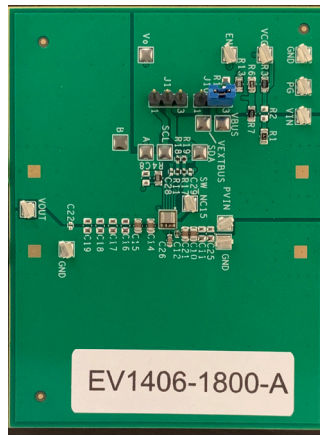

Highlights

- μ POL™ Technology Includes Inductor in a Thermally Enhanced Package
- Small Size 3.3mm x 3.3mm with a height of 1.5mm
- Plug & Play (No External Compensation Required)
- Digital Communication, I2C Serial Bus
- Scalable Output Current, same footprint (3A – 6A)
- Adjustable Output Voltage, $\pm 0.5\%$ Initial accuracy
- -40°C to 125°C Operating Temperature

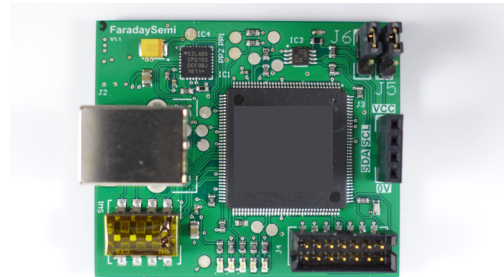

An I2C programming dongle is optional (shown left).

Only required for I2C operations.

Typically used to vary the Vout $\pm 5\text{mV}$ step size over the valid Vout range.

It is provided separately from the standard evaluation boards.

TDK μ POL Evaluation Boards

TDK Part Number	Description	Notes
EV1406-1800-A	Standard Eval Board, FS1406, 1.8V, 6A	Users Guide www.tdk.com/POL under Part No. List
EV1404-3300-A	Standard Eval Board, FS1404, 3.3V, 4A	Users Guide www.tdk.com/POL under Part No. List
EV1403-5000-A	Standard Eval Board, FS1403, 5.0V, 3A	Users Guide www.tdk.com/POL under Part No. List
TDK micro-POL Dongle	I2C Programming Board Optional only need if use I2C	GUI Users Manual & Software www.tdk.com/POL Technical Support Tools

DC-DC Power Solutions

TDK Power: 5W to 25W

Device Options

TDK micro-POL™ Power Modules	MOQ Reel Qty	Voltage	Current Range
FS1406-0600	250, 4k	0.6V to 2.5V	1A to 6A
FS1406-0700	250, 4k	0.7V	1A to 6A
FS1406-0750	250, 4k	0.75V	1A to 6A
FS1406-0800	250, 4k	0.8V	1A to 6A
FS1406-0900	250, 4k	0.9V	1A to 6A
FS1406-1000	250, 4k	1.0V	1A to 6A
FS1406-1050	250, 4k	1.05V	1A to 6A
FS1406-1100	250, 4k	1.1V	1A to 6A
FS1406-1200	250, 4k	1.2V	1A to 6A
FS1406-1800	250, 4k	1.8V	1A to 6A
FS1406-2500	250, 4k	2.5V	1A to 6A
FS1404-2500	250, 4k	2.5V	1A to 4A
FS1404-3300	250, 4k	3.3V	1A to 4A
FS1403-3300	250, 4k	3.3V	1A to 3A
FS1403-5000	250, 4k	5.0V	1A to 3A

Best Performance & Current Density

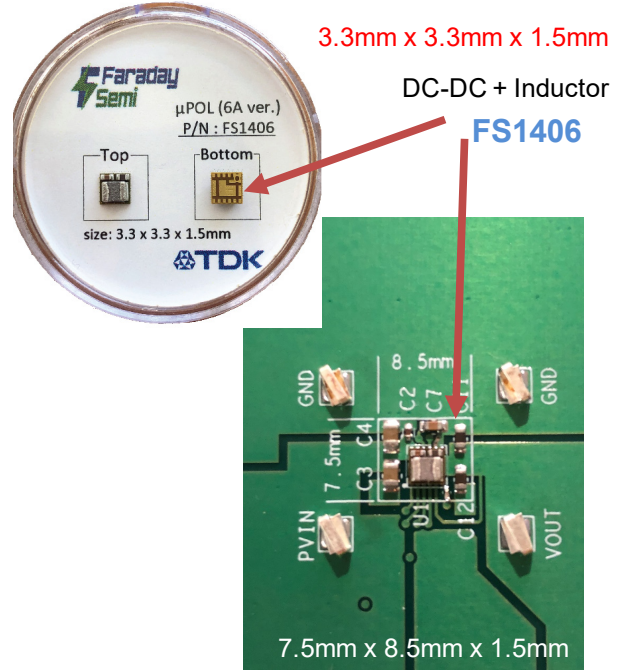

Typical Schematic for FS1406

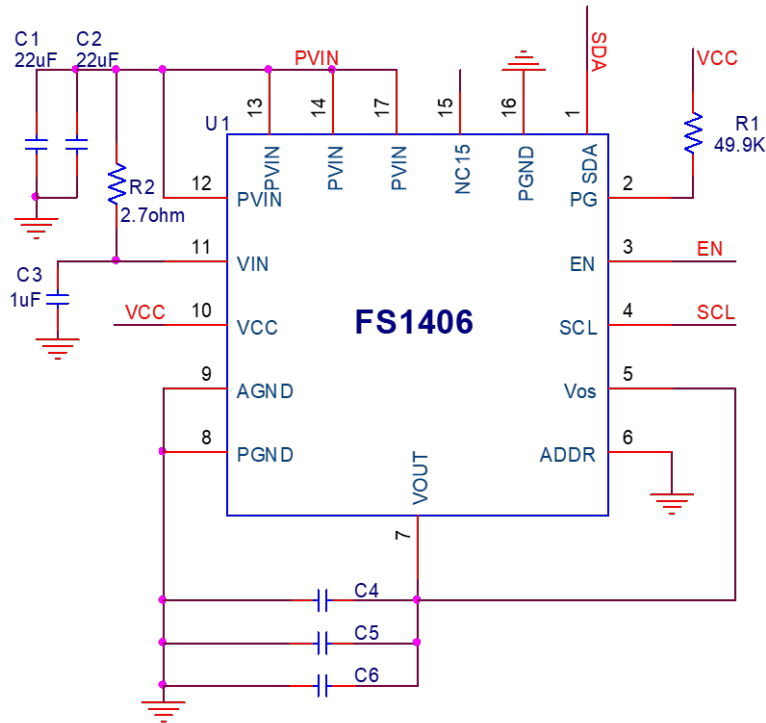

DC-DC Power Solutions

TDK Power: 5W to 25W

Performance Data

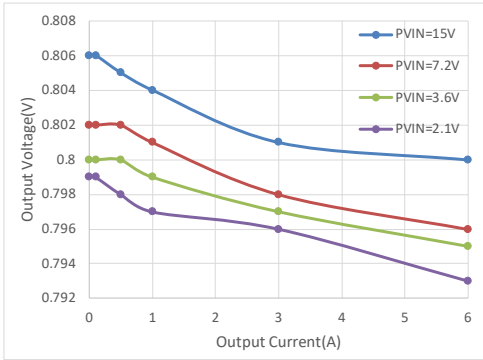

@ -40°C

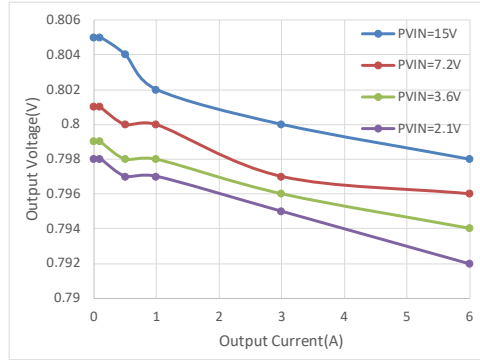

@ 25°C

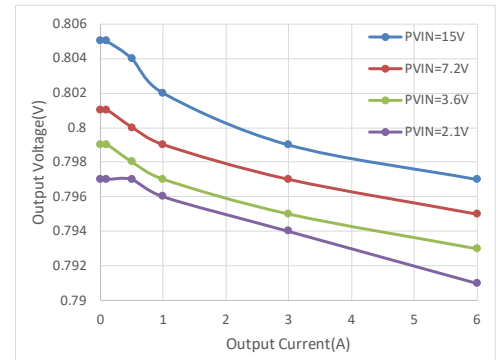

@ 85°C

Line & Load Regulation

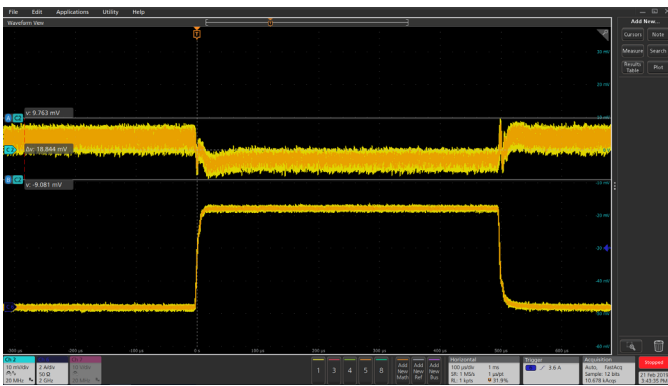

Load Transient 0A to 6A
 V_o peak-peak = 19mV ($\pm 1.2\%$)

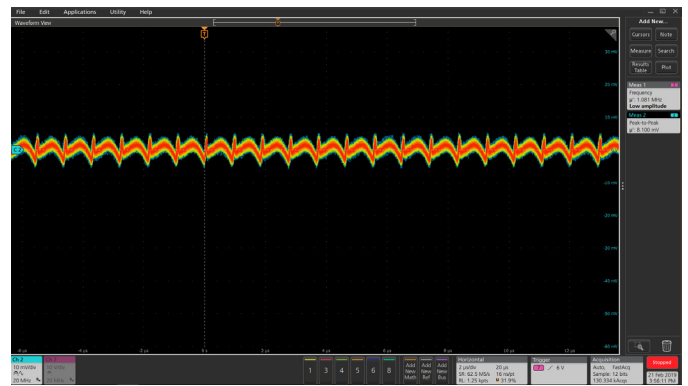

V_o ripple = 8mV @ 6A
 ($\pm 0.51\%$)

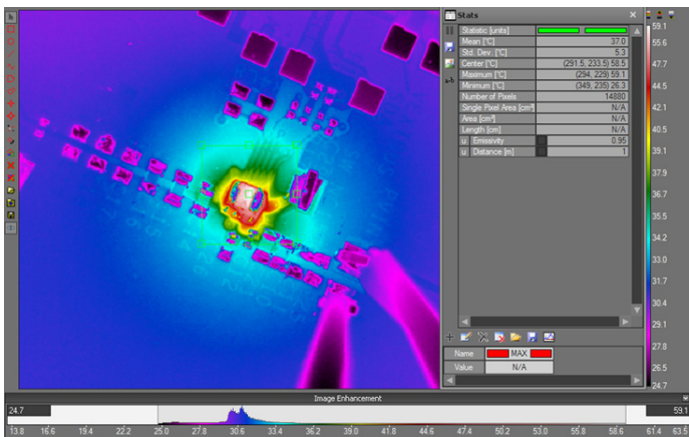

Typical Operating Waveforms
 P_{in}=12.0V, V_o=0.8V, I_o=0-6A,
 Room Temperature,
 No airflow

I_o = 6A, 35°C rise