

ALC70C182DF200

Aliases (A546EH182M200C)

ALC70, Aluminum Electrolytic, 1,800 uF, 20%, 200 VDC, -40/+85°C

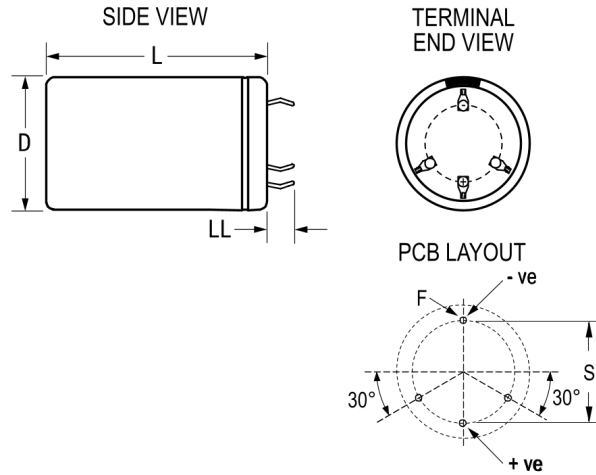

Click [here](#) for the 3D model.

Dimensions

D	35mm +1mm
L	50mm +/-2mm
S	22.5mm +/-0.1mm
LL	6.3mm +/-1mm
F	2mm +/-0.1mm

Packaging Specifications

Sleeving	Yes
Packaging	Bulk, Bag

General Information

Series	ALC70
Dielectric	Aluminum Electrolytic
Description	Snap-In, Aluminum Electrolytic
RoHS	Yes
Lead	4 Pin
AEC-Q200	No
Halogen Free	Yes
Component Weight	80 g
Notes	Dimensions D And L Include Sleeving.
Shelf Life	156 Weeks

Specifications

Capacitance	1,800 uF
Capacitance Tolerance	20%
Voltage DC	200 VDC, 230 VDC (Surge)
Temperature Range	-40/+85°C
Rated Temperature	85°C
Life	15000 Hrs (Rated Voltage And Ripple Current At 85C), 24000 Hrs (Rated Voltage at 85C)
Resistance	126.7 mOhms (100Hz 20C), 80.57 mOhms (10kHz 20C)
Ripple Current	4.11 Amps (100Hz 85C), 7.42 Amps (10kHz 85C)
Leakage Current	2160 uA (5min 20°C)