

OLGA-W

~40° wide beam with flange. Assembly with holder and installation tape.

TECHNICAL SPECIFICATIONS:

Dimensions	Ø 32.0 mm
Height	19.1 mm
Fastening	tape, pin
Colour	black
Box size	476 x 273 x 292 mm
Box weight	10 kg
Quantity in Box	792 pcs
ROHS compliant	yes ⓘ



MATERIAL SPECIFICATIONS:

Component	Type	Material	Colour
OLGA-W	Single lens	PMMA	clear
OLGA-HLD	Holder	PC	
SPUTNIK-TAPE3	Tape	PU tape	black

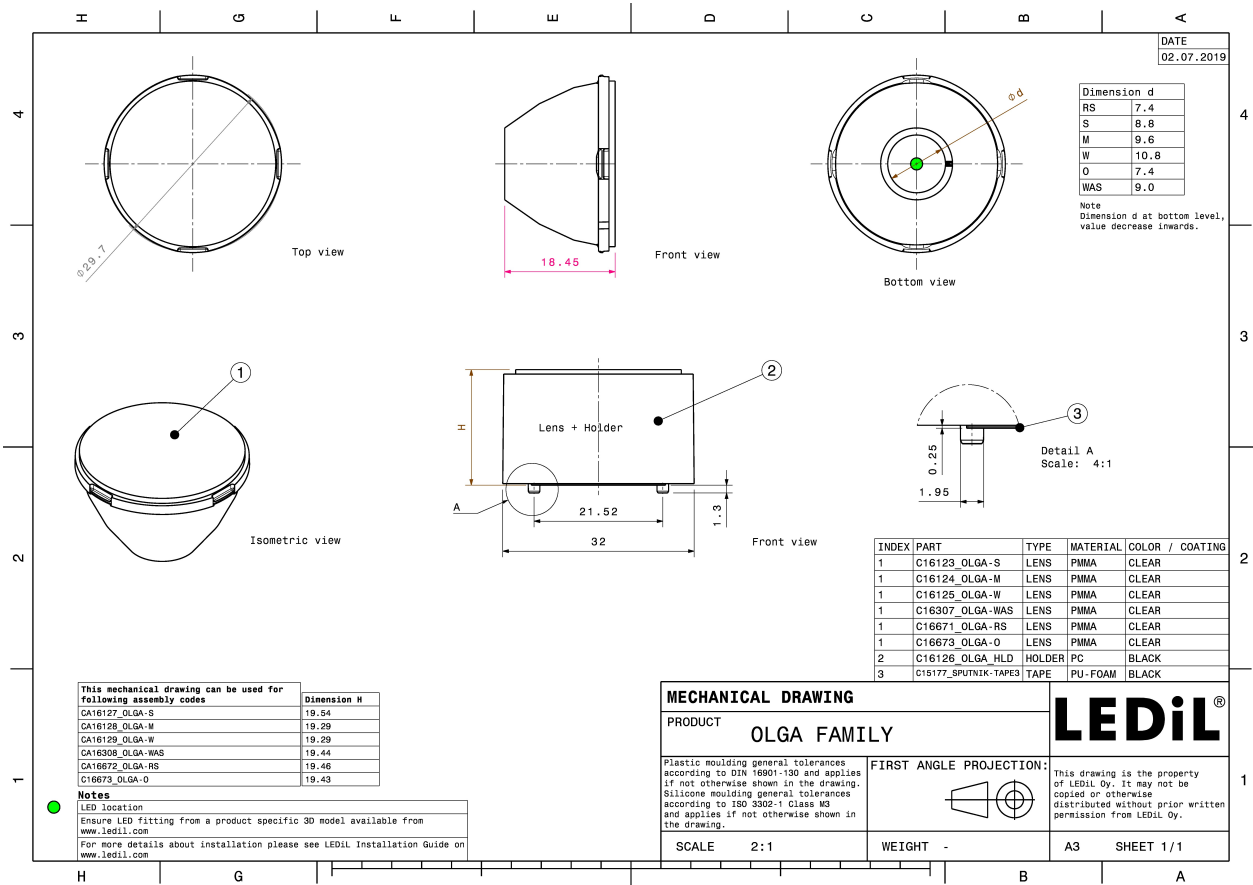

PHOTOMETRIC DATA (MEASURED):

CREE 

LED XD16
 FWHM 32.0°
 Efficiency 82 %
 Peak intensity 2.500 cd/lm
 LEDs/each optic 1
 Light colour White
 Required components:

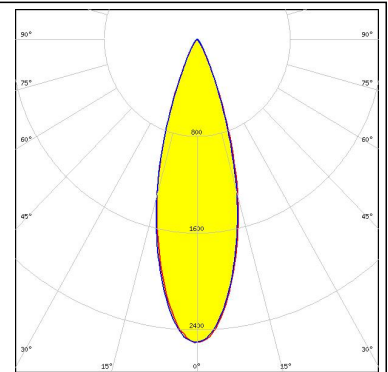

CREE 

LED XHP35 HD
 FWHM 42.0°
 Efficiency 84 %
 Peak intensity 1.600 cd/lm
 LEDs/each optic 1
 Light colour White
 Required components:

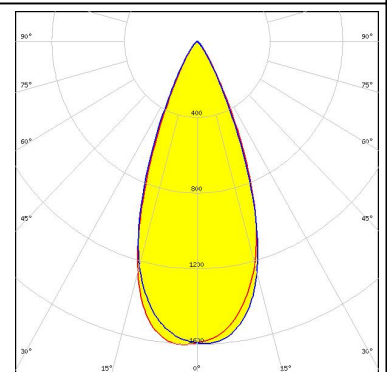
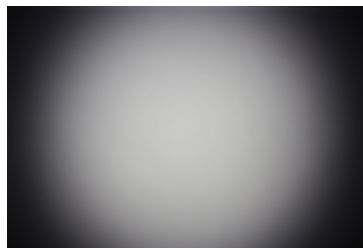

CREE 

LED XHP35 HI
 FWHM 38.0°
 Efficiency 85 %
 Peak intensity 2.000 cd/lm
 LEDs/each optic 1
 Light colour White
 Required components:

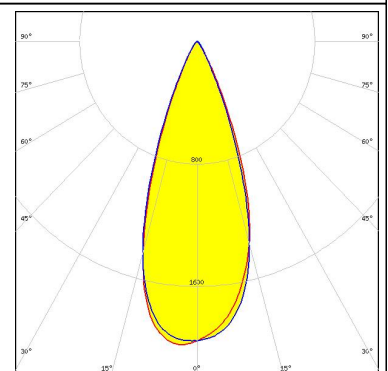
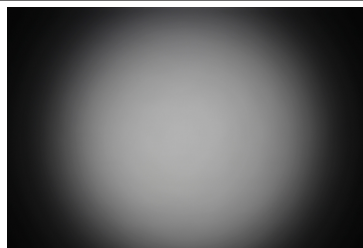

CREE 

LED XHP50
 FWHM 43.0°
 Efficiency 84 %
 Peak intensity 1.500 cd/lm
 LEDs/each optic 1
 Light colour White
 Required components:

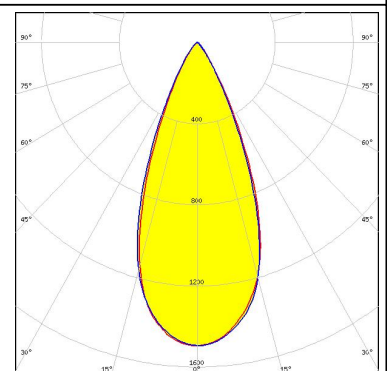
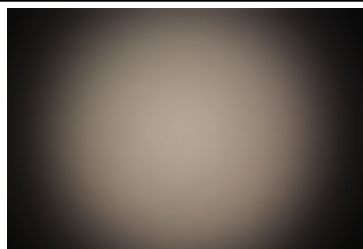

PHOTOMETRIC DATA (MEASURED):

CREE 

LED XHP50.2
 FWHM 42.0°
 Efficiency 84 %
 Peak intensity 1.590 cd/lm
 LEDs/each optic 1
 Light colour White
 Required components:

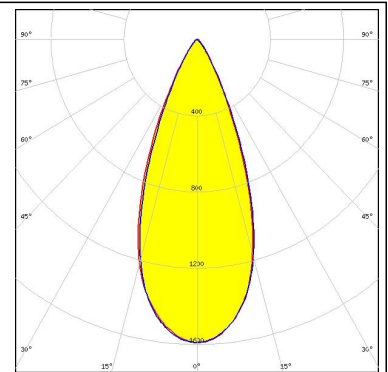

CREE 

LED XHP70
 FWHM 44.0°
 Efficiency 84 %
 Peak intensity 1.400 cd/lm
 LEDs/each optic 1
 Light colour White
 Required components:

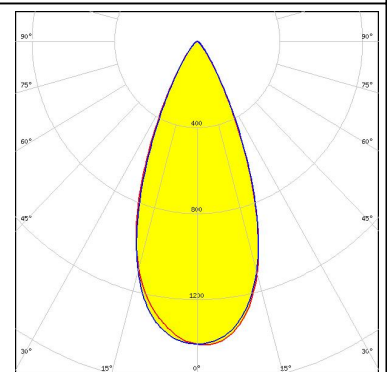
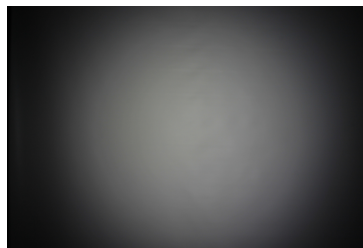

CREE 

LED XHP70.2
 FWHM 44.0°
 Efficiency 83 %
 Peak intensity 1.400 cd/lm
 LEDs/each optic 1
 Light colour White
 Required components:

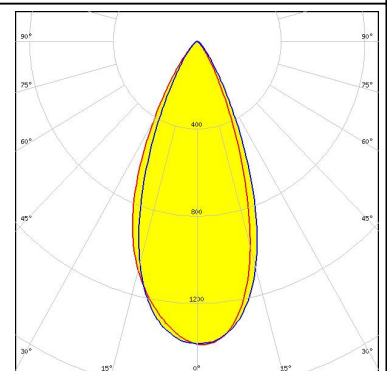
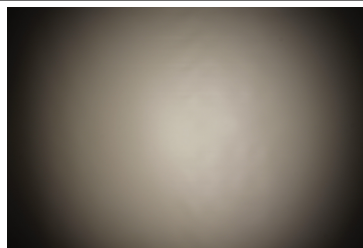

CREE 

LED XP-E2
 FWHM 37.0°
 Efficiency 86 %
 Peak intensity 2.100 cd/lm
 LEDs/each optic 1
 Light colour White
 Required components:

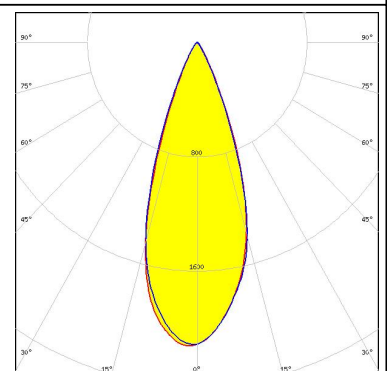
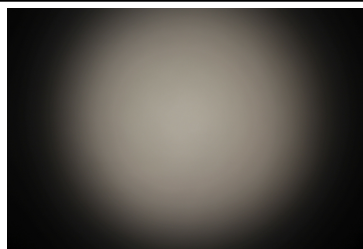

PHOTOMETRIC DATA (MEASURED):



LED XP-G2
 FWHM 41.0°
 Efficiency 86 %
 Peak intensity 1.800 cd/lm
 LEDs/each optic 1
 Light colour White
 Required components:

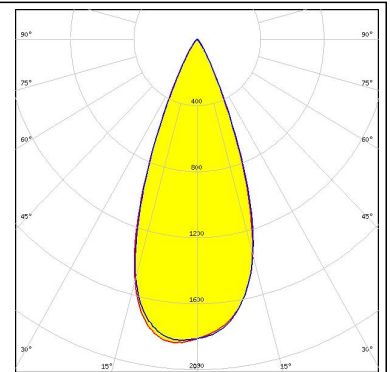

LED XP-G3
 FWHM 37.0°
 Efficiency 85 %
 Peak intensity 2.000 cd/lm
 LEDs/each optic 1
 Light colour White
 Required components:

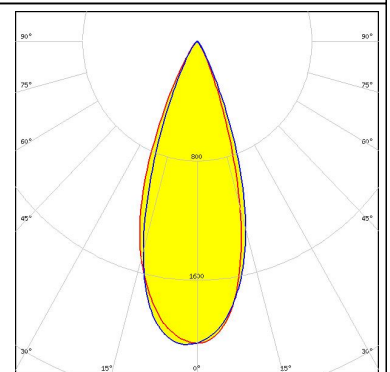
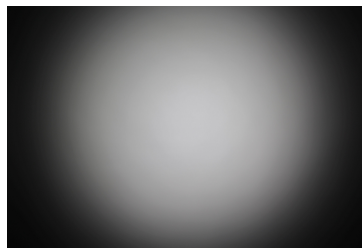

LED XP-L HI
 FWHM 37.0°
 Efficiency 86 %
 Peak intensity 2.200 cd/lm
 LEDs/each optic 1
 Light colour White
 Required components:

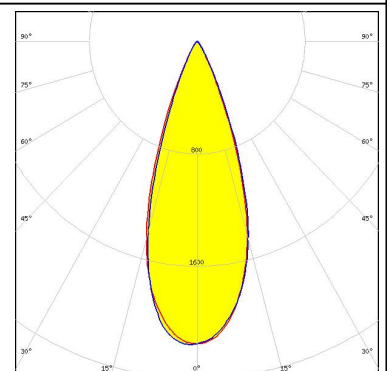
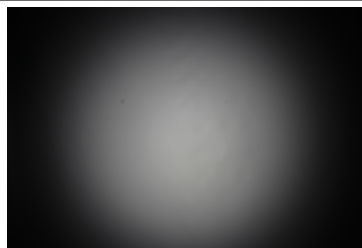

LED XP-L2
 FWHM 39.0°
 Efficiency 84 %
 Peak intensity 1.800 cd/lm
 LEDs/each optic 1
 Light colour White
 Required components:

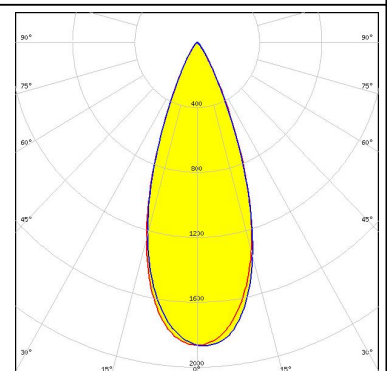
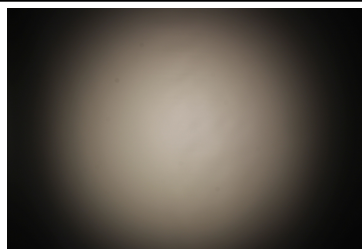

PHOTOMETRIC DATA (MEASURED):



LED XQ-E HD
 FWHM 37.0°
 Efficiency 81 %
 Peak intensity 2.100 cd/lm
 LEDs/each optic 1
 Light colour White
 Required components:

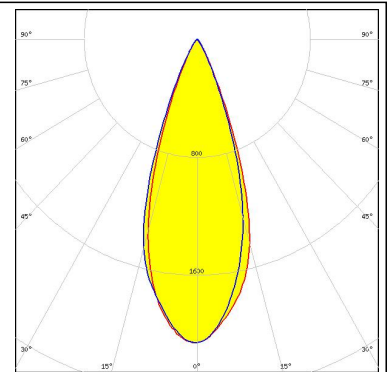
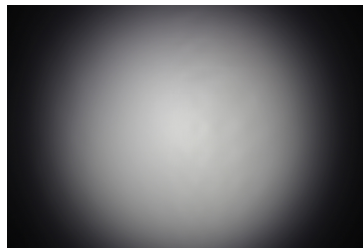

LED XQ-E HI
 FWHM 34.0°
 Efficiency 85 %
 Peak intensity 2.300 cd/lm
 LEDs/each optic 1
 Light colour White
 Required components:

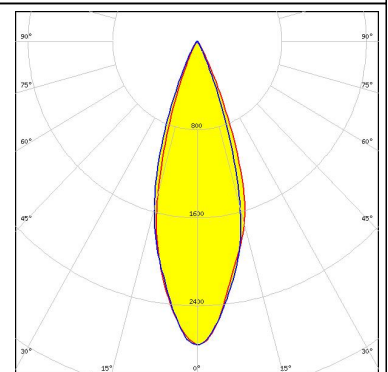
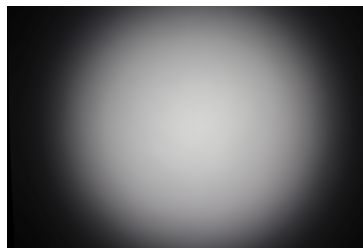

LED XT-E
 FWHM 35.0°
 Efficiency 84 %
 Peak intensity 2.200 cd/lm
 LEDs/each optic 1
 Light colour White
 Required components:

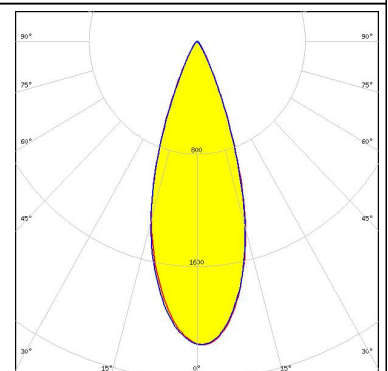
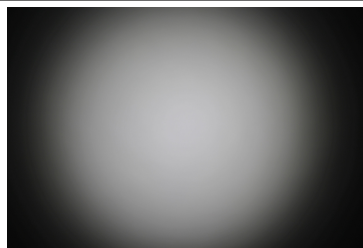

LED LUXEON 5050 Round LES
 FWHM 35.0°
 Efficiency 86 %
 Peak intensity 2.200 cd/lm
 LEDs/each optic 1
 Light colour White
 Required components:

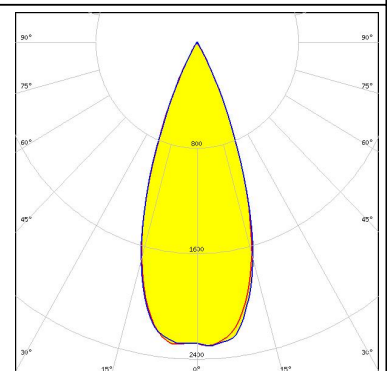
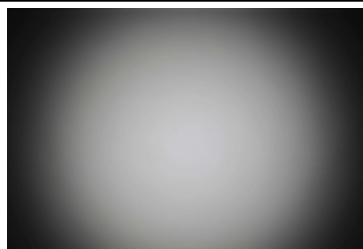

PHOTOMETRIC DATA (MEASURED):

LUMILEDS

LED LUXEON C
 FWHM 31.0°
 Efficiency 84 %
 Peak intensity 2.700 cd/lm
 LEDs/each optic 1
 Light colour White
 Required components:

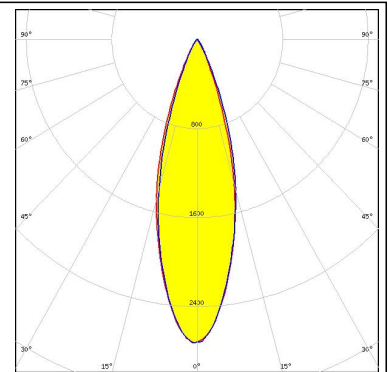

LUMILEDS

LED LUXEON CZ
 FWHM 34.0°
 Efficiency 86 %
 Peak intensity 2.500 cd/lm
 LEDs/each optic 1
 Light colour White
 Required components:

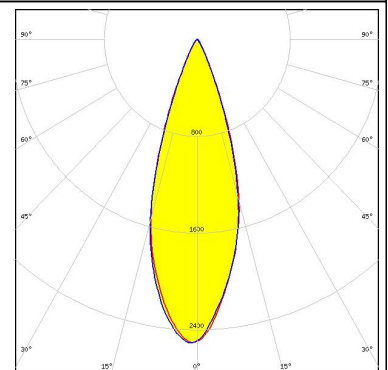
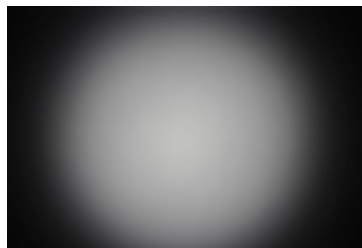

LUMILEDS

LED LUXEON M/MX
 FWHM 42.0°
 Efficiency 84 %
 Peak intensity 1.600 cd/lm
 LEDs/each optic 1
 Light colour White
 Required components:

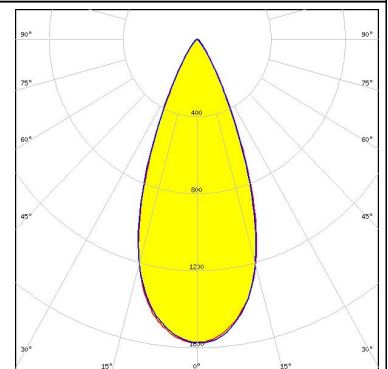
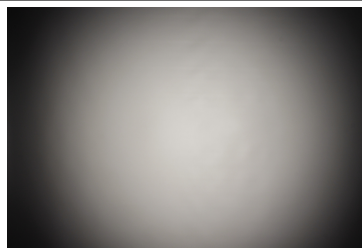

LUMILEDS

LED LUXEON MZ
 FWHM 34.0°
 Efficiency 86 %
 Peak intensity 2.400 cd/lm
 LEDs/each optic 1
 Light colour White
 Required components:

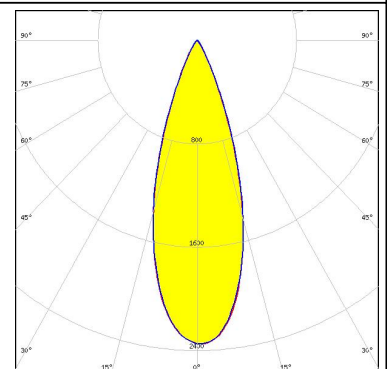
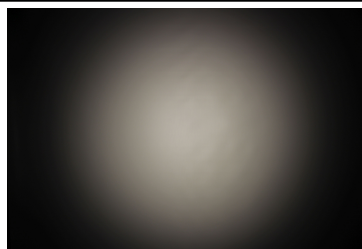

PHOTOMETRIC DATA (MEASURED):

LUMILEDS

LED LUXEON Rebel ES
 FWHM 37.0°
 Efficiency 85 %
 Peak intensity 2.100 cd/lm
 LEDs/each optic 1
 Light colour White
 Required components:

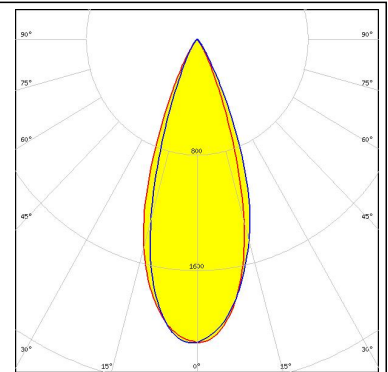

LUMILEDS

LED LUXEON TX
 FWHM 36.0°
 Efficiency 85 %
 Peak intensity 2.200 cd/lm
 LEDs/each optic 1
 Light colour White
 Required components:

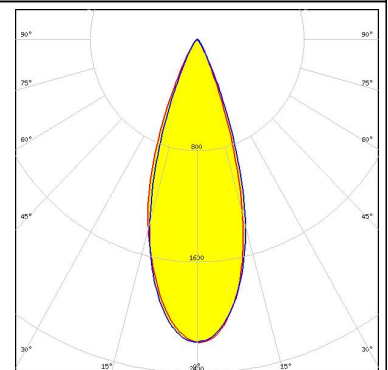
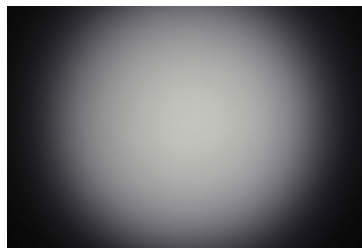

LUMILEDS

LED LUXEON V
 FWHM 38.0°
 Efficiency 84 %
 Peak intensity 2.000 cd/lm
 LEDs/each optic 1
 Light colour White
 Required components:

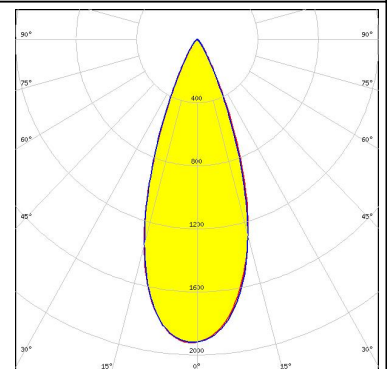
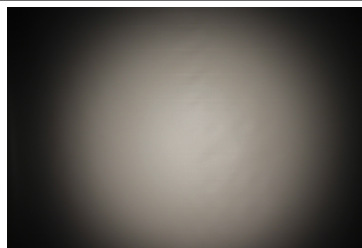

LUMILEDS

LED LUXEON V2
 FWHM 37.0°
 Efficiency 85 %
 Peak intensity 2.100 cd/lm
 LEDs/each optic 1
 Light colour White
 Required components:

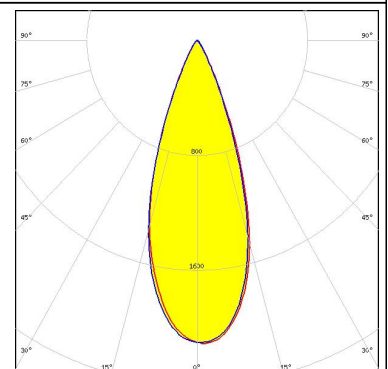
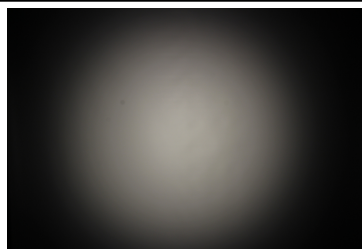

PHOTOMETRIC DATA (MEASURED):

LUMILEDS

LED LUXEON Z
 FWHM 32.0°
 Efficiency 85 %
 Peak intensity 2.700 cd/lm
 LEDs/each optic 1
 Light colour White
 Required components:

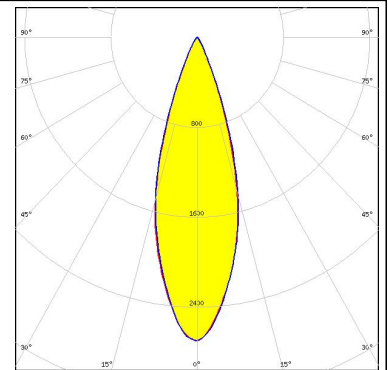
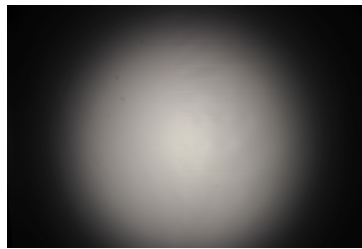

LUMILEDS

LED LUXEON Z ES
 FWHM 35.0°
 Efficiency 86 %
 Peak intensity 2.400 cd/lm
 LEDs/each optic 1
 Light colour White
 Required components:

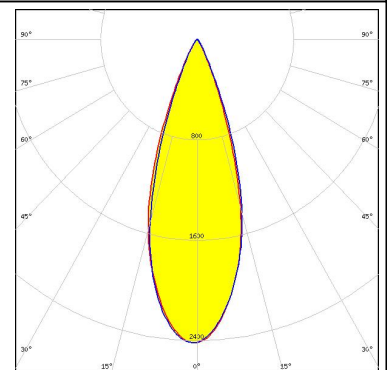
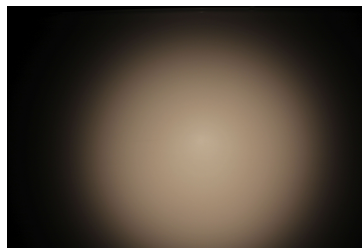

NICHIA

LED NCSxE17A
 FWHM 28.0°
 Efficiency 86 %
 Peak intensity 3.100 cd/lm
 LEDs/each optic 1
 Light colour White
 Required components:

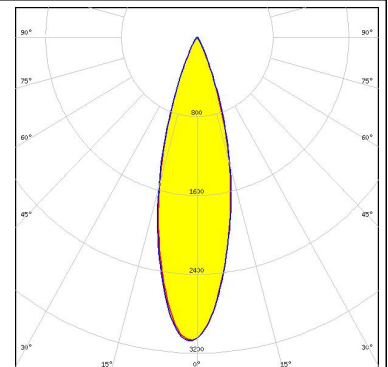



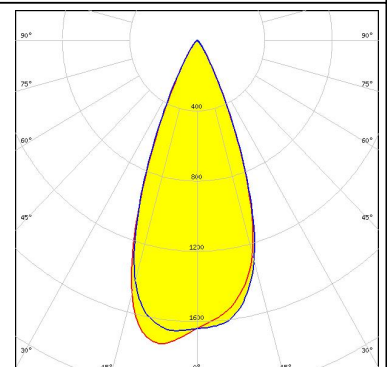
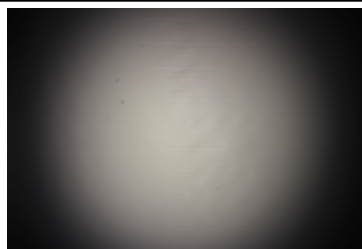

NICHIA

LED NVSW219F
 FWHM 42.0°
 Efficiency 85 %
 Peak intensity 1.700 cd/lm
 LEDs/each optic 1
 Light colour White
 Required components:

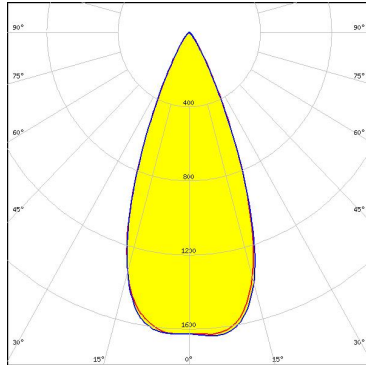
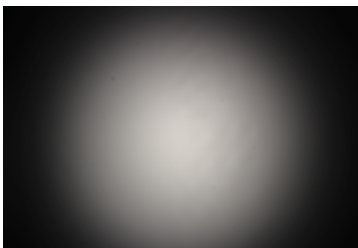
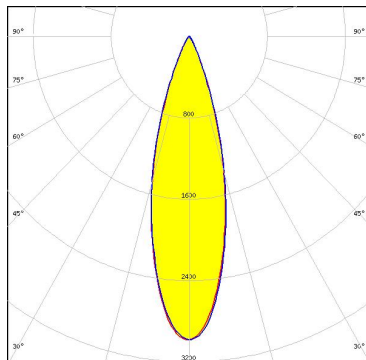

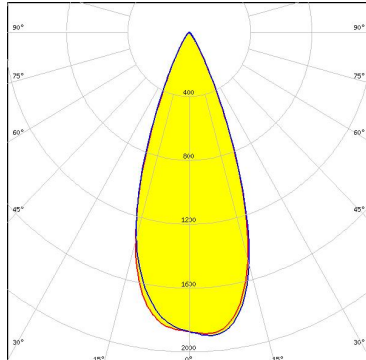
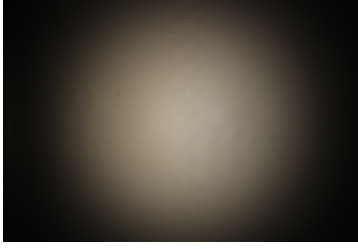
PHOTOMETRIC DATA (MEASURED):

<p>NICHIA</p> <p>LED NVSW319B FWHM 43.0° Efficiency 86 % Peak intensity 1.600 cd/lm LEDs/each optic 1 Light colour White Required components:</p>		
<p>NICHIA</p> <p>LED NVSxE21A FWHM 29.0° Efficiency 86 % Peak intensity 3.000 cd/lm LEDs/each optic 1 Light colour White Required components:</p>		
<p>NICHIA</p> <p>LED NVSxx19B/NVSxx19C FWHM 39.0° Efficiency 85 % Peak intensity 1.900 cd/lm LEDs/each optic 1 Light colour White Required components:</p>		
<p>OSRAM <small>Opto Semiconductors</small></p> <p>LED Duris S8 FWHM 36.0° Efficiency 86 % Peak intensity 2.100 cd/lm LEDs/each optic 1 Light colour White Required components:</p>		

PHOTOMETRIC DATA (MEASURED):

OSRAM
Opto Semiconductors

LED OSCONIQ P 3737 (2W version)
FWHM 35.0°
Efficiency 86 %
Peak intensity 2.300 cd/lm
LEDs/each optic 1
Light colour White
Required components:

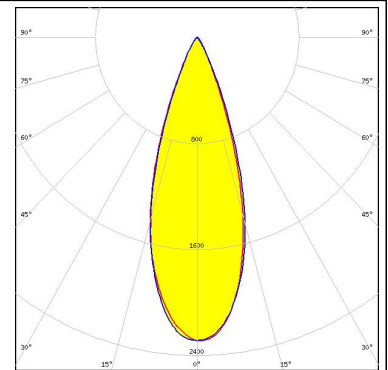

OSRAM
Opto Semiconductors

LED OSCONIQ P 3737 (3W version)
FWHM 38.0°
Efficiency 86 %
Peak intensity 2.000 cd/lm
LEDs/each optic 1
Light colour White
Required components:

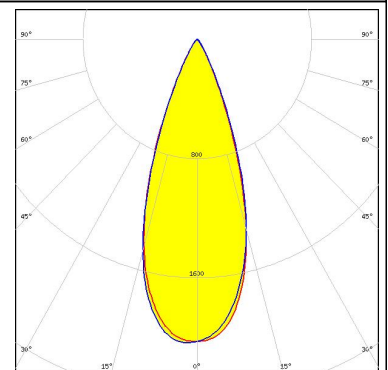
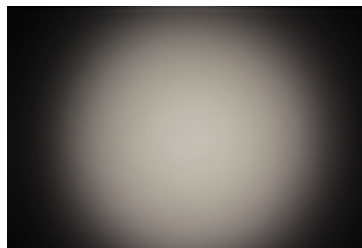

OSRAM
Opto Semiconductors

LED OSCONIQ P 7070
FWHM 39.0°
Efficiency 85 %
Peak intensity 1.800 cd/lm
LEDs/each optic 1
Light colour White
Required components:

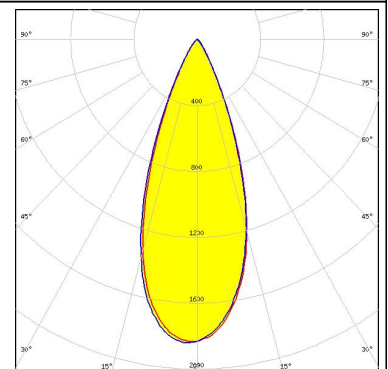
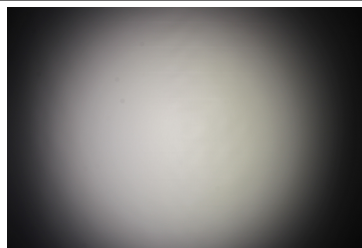

OSRAM
Opto Semiconductors

LED OSLON Black Flat
FWHM 31.0°
Efficiency 85 %
Peak intensity 2.800 cd/lm
LEDs/each optic 1
Light colour White
Required components:

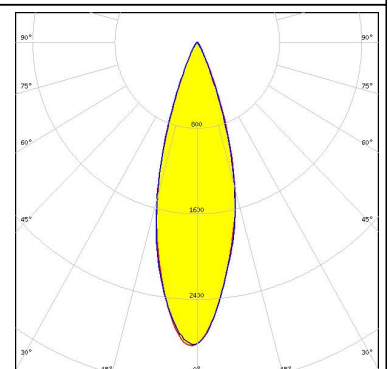
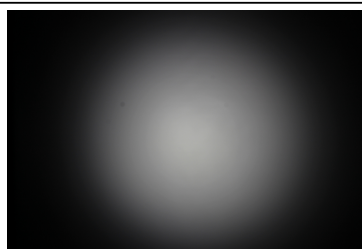

PHOTOMETRIC DATA (MEASURED):

OSRAM
Opto Semiconductors

LED OSLON Square CSSRM2/CSSRM3
 FWHM 39.0°
 Efficiency 85 %
 Peak intensity 2.000 cd/lm
 LEDs/each optic 1
 Light colour White
 Required components:

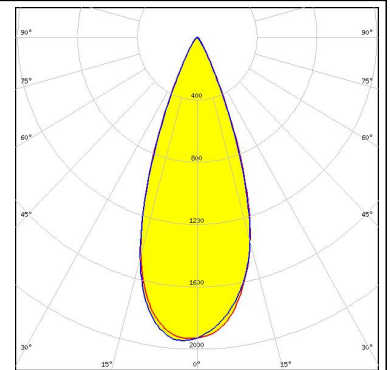

OSRAM
Opto Semiconductors

LED OSLON Square EC
 FWHM 39.0°
 Efficiency 84 %
 Peak intensity 1.900 cd/lm
 LEDs/each optic 1
 Light colour White
 Required components:

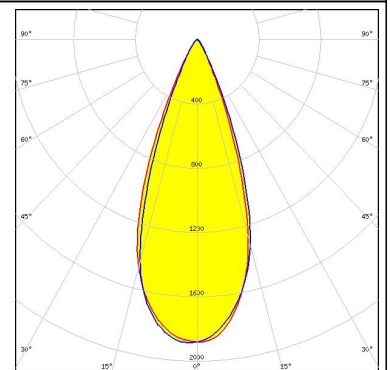
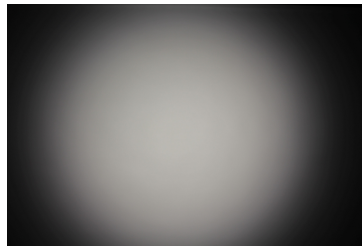

OSRAM
Opto Semiconductors

LED OSLON Square PC
 FWHM 39.0°
 Efficiency 85 %
 Peak intensity 1.900 cd/lm
 LEDs/each optic 1
 Light colour White
 Required components:

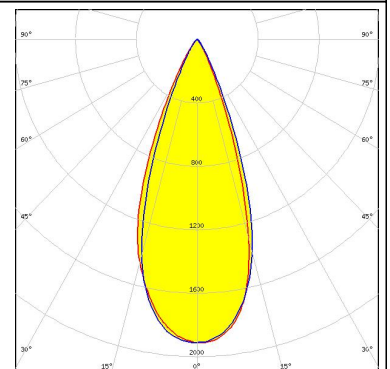
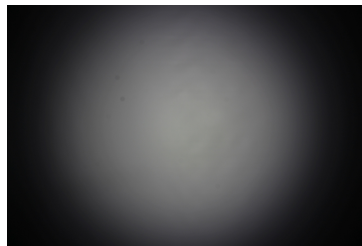

OSRAM
Opto Semiconductors

LED OSLON SSL 150
 FWHM 34.0°
 Efficiency 85 %
 Peak intensity 2.500 cd/lm
 LEDs/each optic 1
 Light colour White
 Required components:

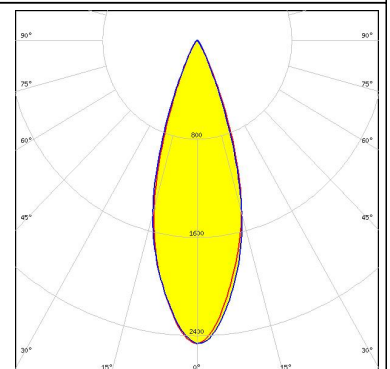
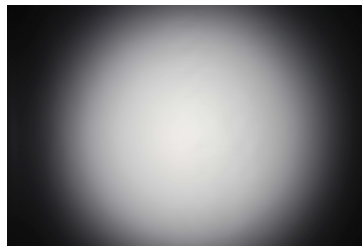

PHOTOMETRIC DATA (MEASURED):

OSRAM
Opto Semiconductors

LED OSLON SSL 80
FWHM 38.0°
Efficiency 85 %
Peak intensity 2.000 cd/lm
LEDs/each optic 1
Light colour White
Required components:

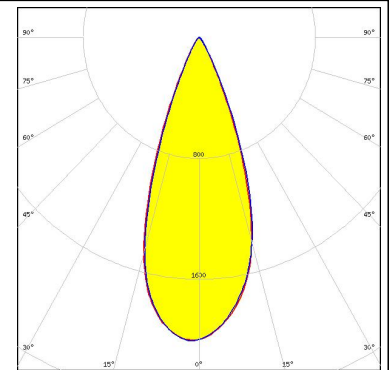

SAMSUNG

LED LH181A
FWHM 28.0°
Efficiency 82 %
Peak intensity 2.800 cd/lm
LEDs/each optic 1
Light colour White
Required components:

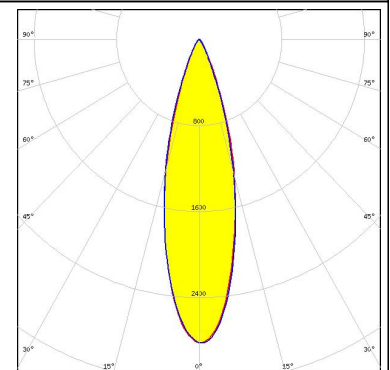
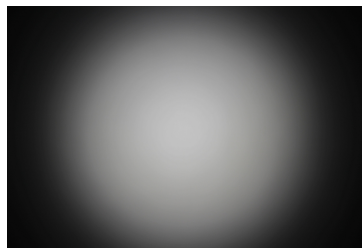

SAMSUNG

LED LH181B
FWHM 30.0°
Efficiency 85 %
Peak intensity 2.800 cd/lm
LEDs/each optic 1
Light colour White
Required components:

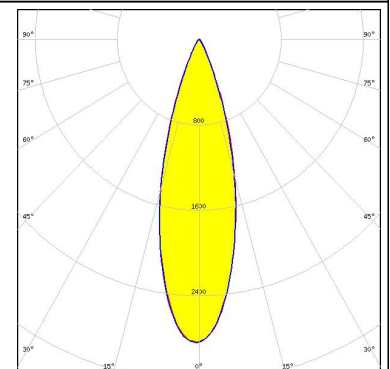
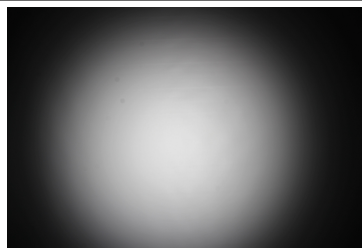

SAMSUNG

LED LH231B
FWHM 31.0°
Efficiency 86 %
Peak intensity 2.700 cd/lm
LEDs/each optic 1
Light colour White
Required components:

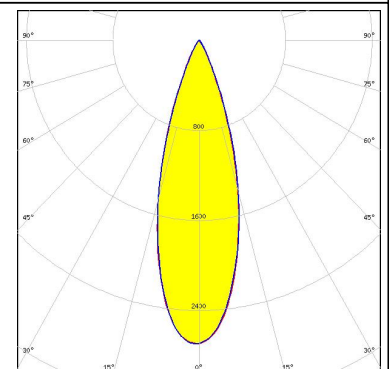
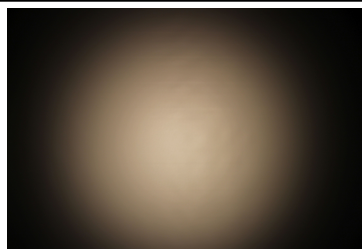

PHOTOMETRIC DATA (MEASURED):

SAMSUNG

LED LH351B
 FWHM 41.0°
 Efficiency 85 %
 Peak intensity 1.800 cd/lm
 LEDs/each optic 1
 Light colour White
 Required components:

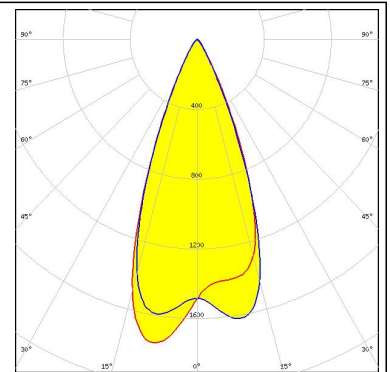

SAMSUNG

LED LH351C
 FWHM 43.0°
 Efficiency 86 %
 Peak intensity 1.700 cd/lm
 LEDs/each optic 1
 Light colour White
 Required components:

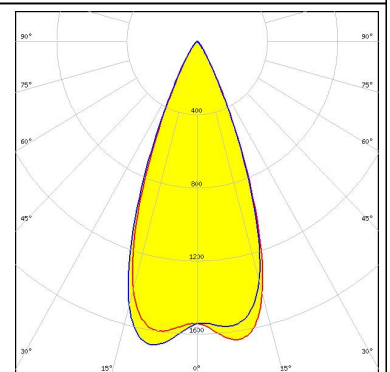
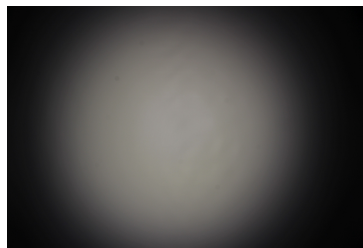

SAMSUNG

LED LH351D
 FWHM 44.0°
 Efficiency 85 %
 Peak intensity 1.600 cd/lm
 LEDs/each optic 1
 Light colour White
 Required components:

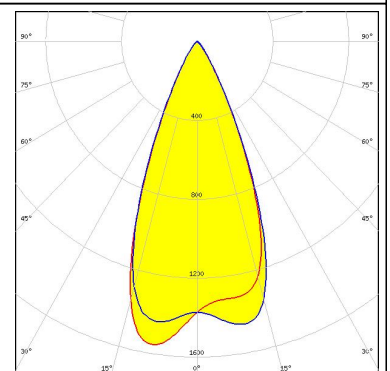
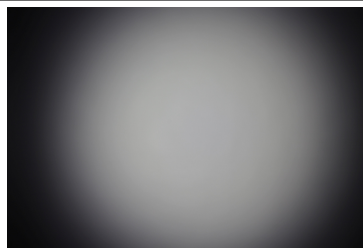

SAMSUNG

LED LH508A
 FWHM 36.0°
 Efficiency 86 %
 Peak intensity 2.200 cd/lm
 LEDs/each optic 1
 Light colour White
 Required components:

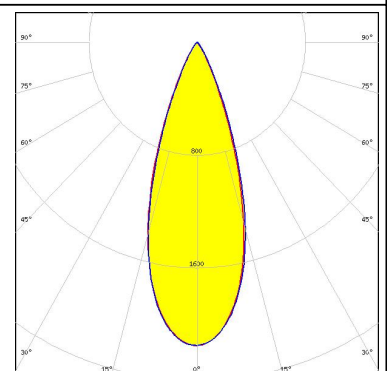
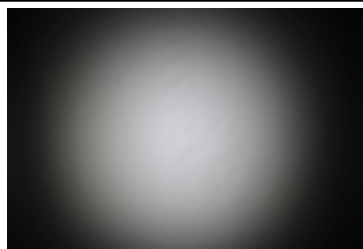

PHOTOMETRIC DATA (MEASURED):

SAMSUNG

LED LM561B
FWHM 36.0°
Efficiency 86 %
Peak intensity 2.300 cd/lm
LEDs/each optic 1
Light colour White
Required components:

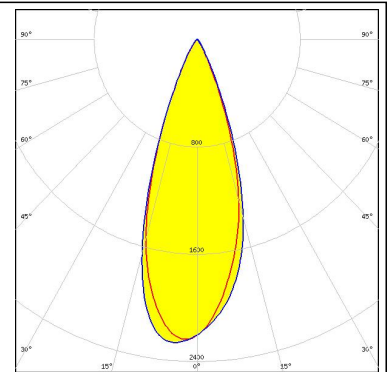

LED Z5M3
FWHM 36.0°
Efficiency 85 %
Peak intensity 2.200 cd/lm
LEDs/each optic 1
Light colour White
Required components:

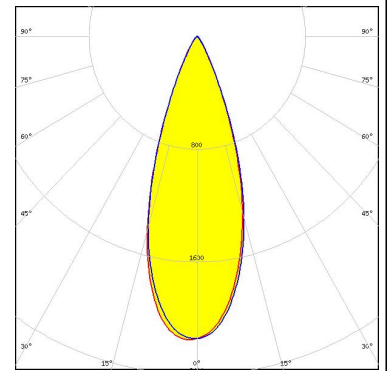
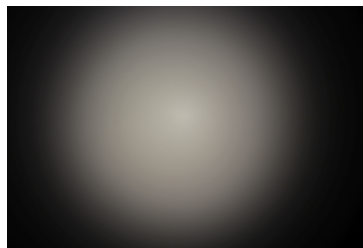

PHOTOMETRIC DATA (SIMULATED):



LED J Series 5050
 FWHM 40.0°
 Efficiency 94 %
 Peak intensity 2.310 cd/lm
 LEDs/each optic 1
 Light colour White
 Required components:

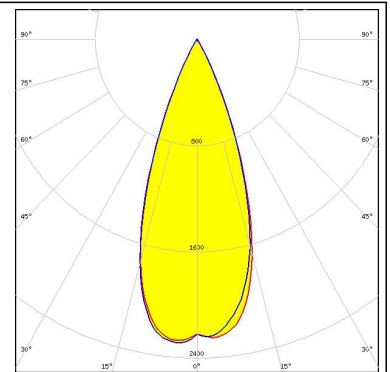

LED XHP50
 FWHM 42.0°
 Efficiency 92 %
 Peak intensity 1.975 cd/lm
 LEDs/each optic 1
 Light colour White
 Required components:

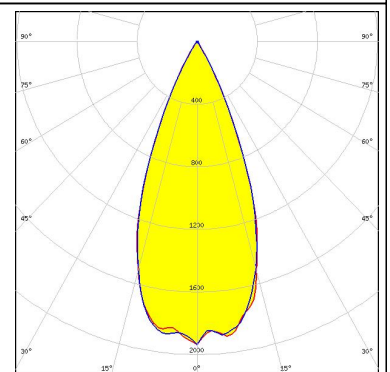

LED LUXEON MZ
 FWHM 33.0°
 Efficiency 93 %
 Peak intensity 3.060 cd/lm
 LEDs/each optic 1
 Light colour White
 Required components:

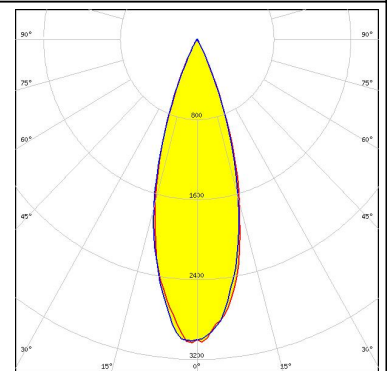

LED NFMW48xA
 FWHM 36.0°
 Efficiency 93 %
 Peak intensity 2.600 cd/lm
 LEDs/each optic 1
 Light colour White
 Required components:

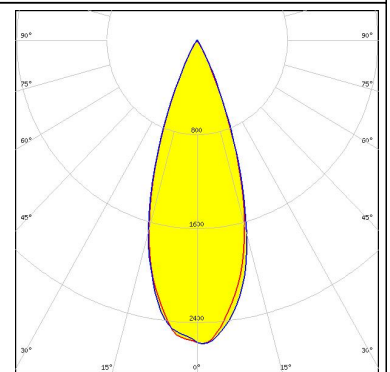

PHOTOMETRIC DATA (SIMULATED):



LED NV4x144A
FWHM 48.0°
Efficiency 90 %
Peak intensity 1.480 cd/lm
LEDs/each optic 1
Light colour White
Required components:

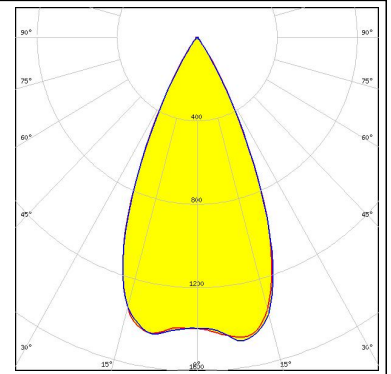

GENERAL INFORMATION:

NOTE: The typical beam angle will be changed by different color, chip size and chip position tolerance. The typical total beam angle is the full angle measured where the luminous intensity is half of the peak value.

MATERIALS:

As part of our continuous research and improvement processes, and to ensure the best possible quality and availability of our products, LEDiL reserves the right to change material grades without notice.

PRODUCT DATA USER AGREEMENT AND DISCLAIMER:

The measured data in the provided downloadable LEDiL Product Datasheets and Mechanical 2D-Drawings is rounded and provided as reference for planning. LEDiL Oy's optical specifications have been verified by conducting performance testing of the products in accordance with the company's quality system. The reported data are averaged results of multiple measurements with typical variation. LEDiL Oy reserves the right to without prior notification make changes and improvements to its products.

LEDiL Oy assumes neither warranty, nor guarantee nor any other liability of any kind for the contents and correctness of the provided data. The provided data has been generated with highest diligence but the provided data may in reality not represent the complete possible variation range of all intrinsic parameters. Therefore, in certain cases a deviation from the provided data could occur.

LEDiL Oy reserves the right to undertake technical changes of its products without further notification which could lead to changes in the provided data. LEDiL Oy assumes no liability of any kind for the possible deviation from any provided data or any other damage resulting from the usage of the provided data.

The user agrees to this disclaimer and user agreement with the download or usage of the provided files.

LEDiL Oy

Joensuunkatu 13
FI-24240 SALO
Finland

LEDiL Inc.

228 West Page Street
Suite D
Sycamore IL 60178
USA

Local sales and technical support

[www.ledil.com/
where_to_buy](http://www.ledil.com/where_to_buy)

Shipping locations

Salo, Finland
Hong Kong, China

Distribution Partners

[www.ledil.com/
where_to_buy](http://www.ledil.com/where_to_buy)