



A Product Line of
Diodes Incorporated



SPECIFICATION FOR APPROVAL

CUSTOMER _____

NOMINAL FREQUENCY 33.333000 MHz

HOLDER TYPE TYPE FK 3.2x2.5 SEAM SEALED CRYSTAL CLOCK OSCILLATOR

SPEC. NO. (P/N) FK3330016

CUSTOMER P/N _____

ISSUE DATE June 5, 2018

VERSION B

| APPROVED | PREPARED | QA |
|----------|----------|----|
| | | |

Diodes Incorporated

No.2, Ziqiang 5th Rd., Zhongli Industrial Park,
Zhongli Dist., Taoyuan City 32063, Taiwan (R.O.C.)
TEL: 886-3-451-8888
FAX: 886-3-461-3865
<https://www.diodes.com>

*Pb-free
*RoHS Compliant
*HF-Halogen Free
*REACH Compliant

TYPE FK 3.2x2.5 SEAM SEALED CRYSTAL CLOCK OSCILLATOR

FK3330016

VER. B 5-Jun-18

ELECTRICAL SPECIFICATIONS

SRe Part Number : FK3330016

| Item | Symbol | Specifications | Units | Notes |
|---------------------------------|--------------------------------|---------------------|-------|--------------------------------------|
| Nominal Frequency | F _o | 33.333000 | MHz | |
| Frequency Stability | FT | ± 50 | ppm | **See note |
| Operating Temperature Range | TR | -20 to +70 | °C | |
| Supply Voltage | V _{DD} | +3.3 ± 5.0% | V | |
| Logic Type | LT | LVC MOS | | |
| Supply Current, Output Enabled | I _{DD} /OE | 10 | mA | Max. |
| Supply Current, Output Disabled | I _{DD} /OD | 10 | µA | Max. |
| Duty Cycle (Symmetry) | DC/SY | 45 / 55 | % | Measured 50% of Waveform |
| Rise / Fall Time | T _R /T _F | 5 | ns | Max. measured 10/90% of Waveform |
| Output Voltage "0" Level | V _{OL} | 10% V _{DD} | V | Max at I _{OL} = 4.0mA Min. |
| Output Voltage "1" Level | V _{OH} | 90% V _{DD} | V | Min at I _{OH} = -4.0mA Max. |
| Output Load | CL | 30 | pF | Max. |
| Jitter, Phase | RMS | 1 | ps | Max. 12kHz ~ 5MHz Frequency Band |
| Jitter, Accumulated | RMS(1-σ) | 3 | ps | Max. 20,000 Consecutive Periods |
| Jitter, Peak to Peak | Pk-Pk | 30 | ps | Max. 100,000 Random Periods |
| Start Up Time | | 10 | ms | Max. |
| Storage Temperature Range | | -55 to +125 | °C | |

※ This product doesn't include harmful substance that stipulated by SONY SS-00259 Level 1 and S-AT2-001 Level 1 standard. RoHS Compliant (Pb - Free).

**Stability includes all combinations of Operating Temperature, Load changes, rated Input (Supply) Voltage changes, Initial Calibration Tolerance (25°C), Aging (1 year at 25°C Average Effective Ambient Temperature), Shock and Vibration.

Output Enable / Disable Function

| Parameter | Min. | Typ. | Max. | Units | Notes |
|--|--------------------|------|--------------------|-------|----------------|
| Input Voltage (Pin1), Output Enable | 0.7V _{DD} | | | V | Or Open |
| Input Voltage (Pin1), Output Disable (low power standby) | | | 0.3V _{DD} | V | Output is Hi-Z |
| Internal Pullup Resistance | 30 | | | KΩ | |
| Output Disable Delay | | | 50 | ns | |

TYPE FK 3.2x2.5 SEAM SEALED CRYSTAL CLOCK OSCILLATOR

FK3330016

VER. B 5-Jun-18

TEST CIRCUIT

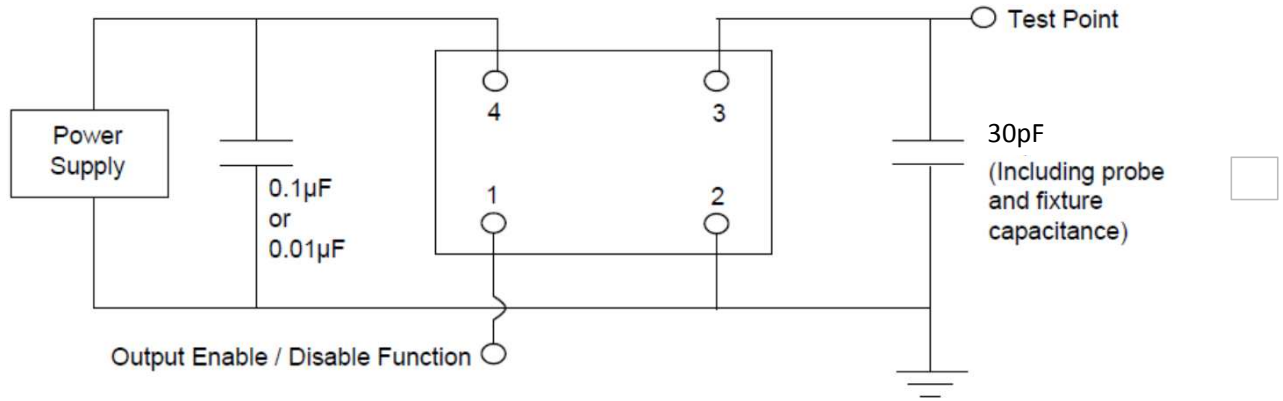

OUTPUT WAVEFORM

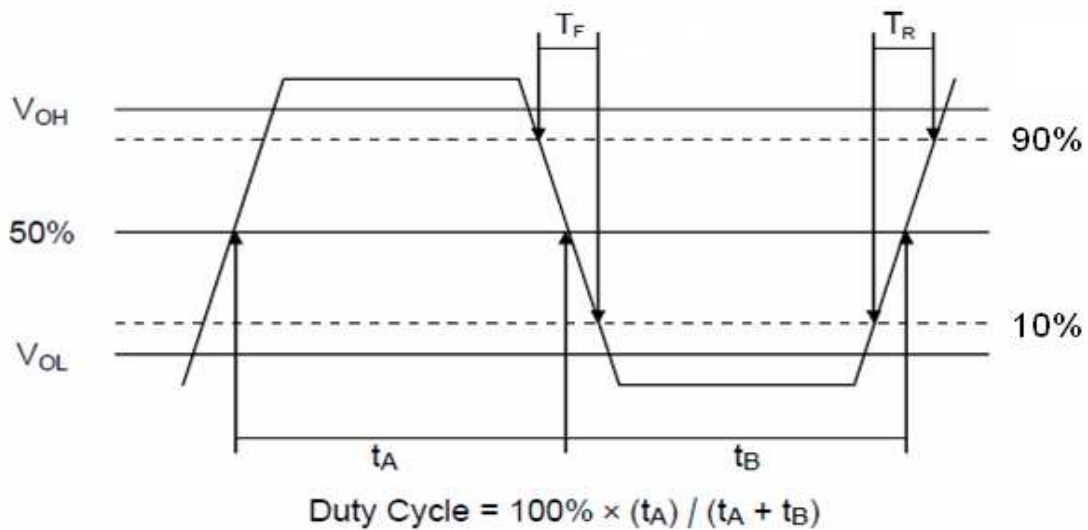

TYPE FK 3.2x2.5 SEAM SEALED CRYSTAL CLOCK OSCILLATOR

FK3330016

VER. B 5-Jun-18

RELIABILITY SPECIFICATIONS

ENVIRONMENTAL:

- a) THERMAL SHOCK: MIL-STD-883, Method 1011, Condition A
- b) MOISTURE RESISTANCE: MIL-STD-883, Method 1004
- c) VIBRATION: MIL-STD-883, Method 2007, Condition A
- d) RESISTANCE TO SOLDERING HEAT: J-STD-020D Table 5-2 Pb-free devices (except 2 cycles max)
- e) HAZARDOUS SUBSTANCE: Pb - free and RoHS Compliant.

MECHANICAL:

- a) SHOCK: MIL-STD-883, Method 2002, Condition B
- b) SOLDERABILITY: JESD22-B102-D Method 2 (Preconditioning E)
- c) TERMINAL STRENGTH: MIL-STD-883, Method 2004, Test Condition D
- d) GROSS LEAK: MIL-STD-883, Method 1014, Condition C
- e) FINE LEAK: MIL-STD-883, Method 1014, Condition A2, $R1=2 \times 10^{-8}$ atm cc/s
- f) SOLVENT RESISTANCE: MIL-STD-202, Method 215

SUGGESTED IR REFLOW PROFILE

*As per IPC-JEDEC J-STD-020D

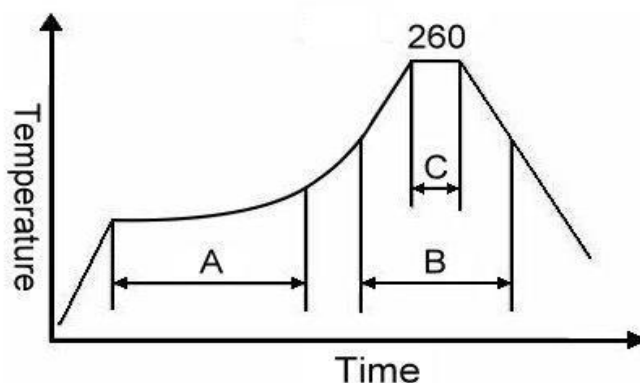

Note:

| | Stage | Temperature | Time |
|---|--------------|-------------|------------|
| A | Preheat | 150~200°C | 60~120 Sec |
| B | Primary Heat | 217°C | 60~150 Sec |
| C | Peak | 260°C | 10 Sec |

TYPE FK 3.2x2.5 SEAM SEALED CRYSTAL CLOCK OSCILLATOR

FK3330016

VER. B 5-Jun-18

MARKING

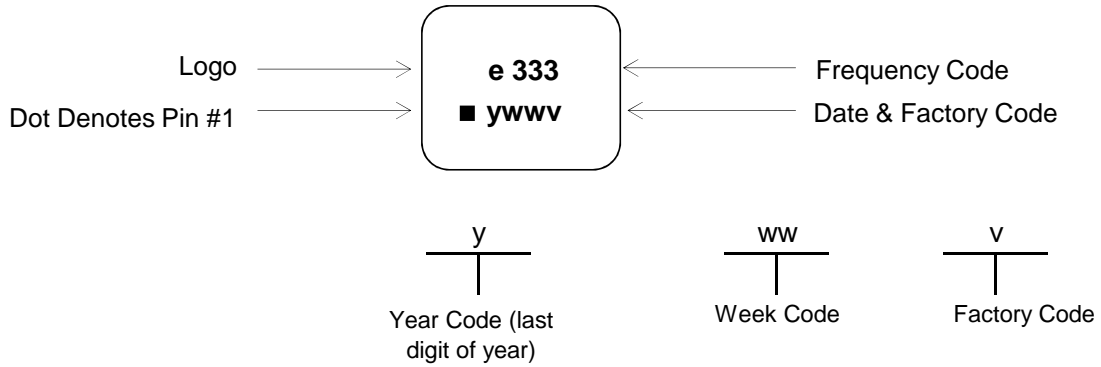

MECHANICAL DRAWINGS (Scale: None. Dimensions are in mm.)

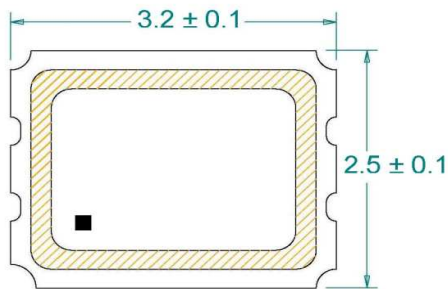

Recommended Land Pattern*

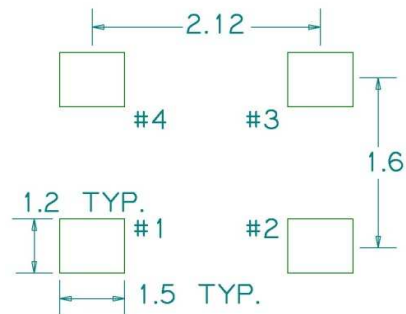

*External high-frequency power decoupling is recommended. (see test circuit for minimum recommendation). To ensure optimal performance, do not route traces beneath the package.

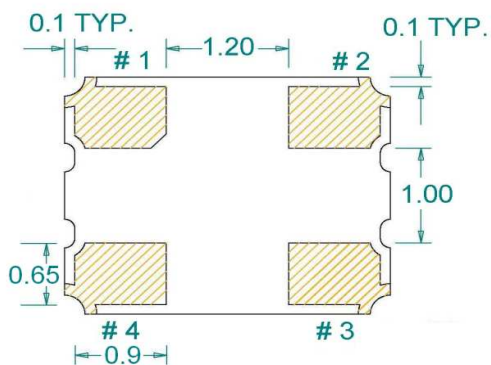

(Bottom View)

| Pin | Function |
|-----|-----------------|
| 1 | OE |
| 2 | Ground |
| 3 | Clock Output |
| 4 | V _{DD} |

TYPE FK 3.2x2.5 SEAM SEALED CRYSTAL CLOCK OSCILLATOR

FK3330016

VER. B 5-Jun-18

PACKING

