

Device Features

- Gain = 31.0 dB @ 3500MHz
- OIP3 = 30.0 dBm @ 3500MHz
- Output P1 dB = 19.5 dBm @ 3500 MHz
- 5G NR ACLR = 8.9 dBm @ 3500MHz
- Internally matched to 50 ohms
- Fast shut down to support TDD systems
- Green/RoHS2 Compliant QFN 16L 3x3 Package

Product Description

The BGM26 is a 2stage Gain Block Amp for Higher gain BroadBand, GaAs E-pHEMT Amplifier that is ideal for applications demanding high linearity in a wideband of 1700-6000 MHz. BGM26 is in RoHS2 compliant QFN 16L 3x3 mm² surface mount package. It can be used in fast shutdown switching speed for TD-LTE & TD 5G NR application. These devices are 100% DC and RF tested to assure quality and performance.

Applications

- 5G Massive MIMO
- Mobile Infrastructure
- Repeater / DAS
- General Purpose Wireless
- TDD / FDD System

Applications Circuit

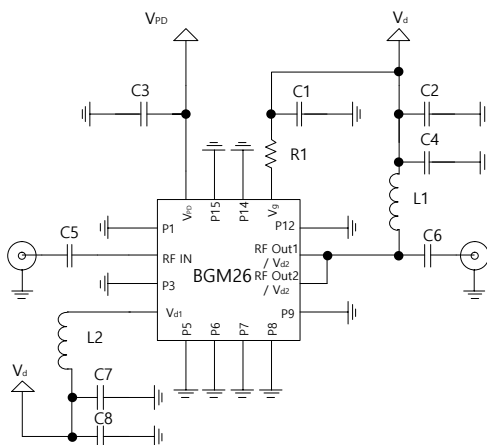

*BOM : refer to the page 5.

*Refer to App note for 5.8G circuit

Part Marking

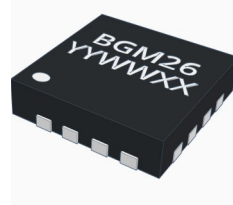

Electrical Specifications

Device performance _ measured on a BeRex evaluation board at 25°C, V_d=5V, 50 Ω system.

Parameter	Conditions	Min	Typ	Max	Unit
Operational Frequency Range		1700		6000	MHz
Test Frequency			3500		MHz
Gain		29.5	31.0		dB
Input Return Loss			-21.5		dB
Output Return Loss			-9.6		dB
Output IP3	2 dBm / tone , Δf=1 MHz	27.0	30.0		dBm
Output P1dB		18.5	19.5		dBm
5G NR ACLR ¹		7.9	8.9		dBm
Noise Figure ²			3.0	3.2	dB

Device performance _ measured on a BeRex evaluation board at 25°C, V_d=3.3V, 50 Ω system.

Parameter	Conditions	Min	Typ	Max	Unit
Operational Frequency Range		1700		6000	MHz
Test Frequency			3500		MHz
Gain		27.5	29.0		dB
Input Return Loss			-34.5		dB
Output Return Loss			-10.2		dB
Output IP3	0 dBm / tone , Δf=1 MHz	22.0	25.0		dBm
Output P1dB		13.5	14.5		dBm
5G NR ACLR ¹		2.2	3.2		dBm
Noise Figure ²			3.2	3.4	dB

¹ACLR Channel Power measured at -50dBc.

- 5G NR Downlink FR1 : SCS 30KHz, CBW 100MHz, 256QAM, PAR 9.66 at 0.01% Prob.

² NF : PCB losses at input and output transmission lines are not de-embedded .

Recommended Operating Conditions

Parameter	Min	Typ	Max	Unit
Bandwidth	1700		6000	MHz
I _d @ (V _d = 5.0V)	72	90	108	mA
I _d @ (V _d = 3.3V)	45	56	67	mA
V _d	3.3	5	5.25	V
dG/dT		0.006		dB/°C
R _{TH}		50		°C/W
Operating Case Temperature	-40		+105	°C

Electrical specifications are measured at specified test conditions.

Specifications are not guaranteed over all recommended operating conditions.

Recommended Operating Conditions

Parameter	Condition	Min.	Typical	Max.	Unit
Shutdown Control	On state	1.17		V_d	V
	Off state(shutdown)	0		0.63	V
Current, I_d	On state 5V	72	90	108	mA
	On state 3.3V	45	56	67	mA
	Off state(shutdown)		3		mA
Switching Time	Rise time(10% to 90%)		200		ns
	Fall time(90% to 10%)		200		ns

Absolute Maximum Ratings

Parameter	Rating	Unit
Storage Temperature	-55 to +155	°C
Junction Temperature	150	°C
Supply Voltage	+6	V
Supply Current	180	mA
Input RF Power	23	dBm

Operation of this device above any of these parameters may result in permanent damage.

Typical RF Performance ($V_d=5V$, $I_d=90mA$, $T=25^\circ C$)

Parameter	Frequency					Unit
	1800	2140	2650	3500	4900	MHz
Gain	29.2	29.5	30.0	31.0	28.3	dB
S11	-10.1	-10.4	-11.7	-21.5	-12.6	dB
S22	-15.8	-9.8	-8.0*	-9.6*	-17.6	dB
OIP3 ¹	31.6	31.4	30.9	30.0	28.9	dBm
P1dB	19.4	19.5	19.9	19.5	17.8	dBm
LTE 20M ACLR ³	9.3	9.5	9.1	-	-	dBm
5G NR ACLR ⁴	-	-	-	8.9	6.8	dBm
Noise Figure ⁵	2.8	2.9	2.9	3.0	3.5	dB

Typical RF Performance ($V_d=3.3V$, $I_d=56mA$, $T=25^\circ C$)

Parameter	Frequency					Unit
	1800	2140	2650	3500	4900	MHz
Gain	27.2	27.6	28.1	29.0	25.1	dB
S11	-9.7	-10.3	-12.7	-34.5	-9.3	dB
S22	-14.1	-9.0	-7.2	-10.2	-14.1	dB
OIP3 ²	26.7	26.6	26.2	25.0	22.2	dBm
P1dB	15.2	15.6	15.6	14.5	12.3	dBm
LTE 20M ACLR ³	4.0	4.0	3.2	-	-	dBm
5G NR ACLR ⁴	-	-	-	3.2	0.3	dBm
Noise Figure ⁵	3.0	3.0	3.0	3.2	3.8	dB

¹ 2 dBm / tone, $\Delta f=1$ MHz

² 0 dBm / tone, $\Delta f=1$ MHz

³ LTE set-up: 3GPP LTE, FDD E-TM3.1, 20MHz BW, ± 20 MHz offset, PAR 9.75 at 0.01% Prob. ACLR Channel Power measured at -50dBc

⁴ 5G NR Downlink FR1 : SCS 30KHz, CBW 100MHz, 256QAM, PAR 9.66 at 0.01% Prob. ACLR Channel Power measured at -50dBc

⁵ NF : Losses on input and output transmission lines on PCB are not de-embedded.

* S22 can be improved to less than -10dB, if L1 is 1.2nH

V-I Characteristics

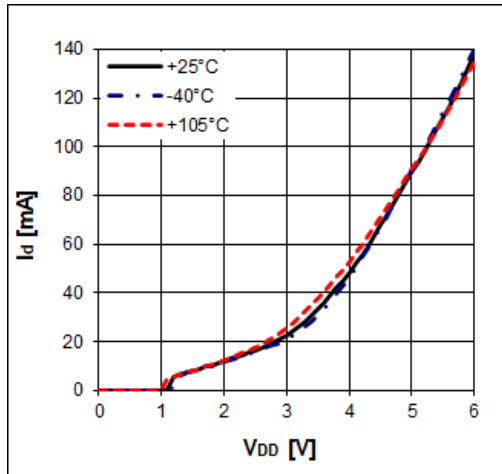

Evaluation Board

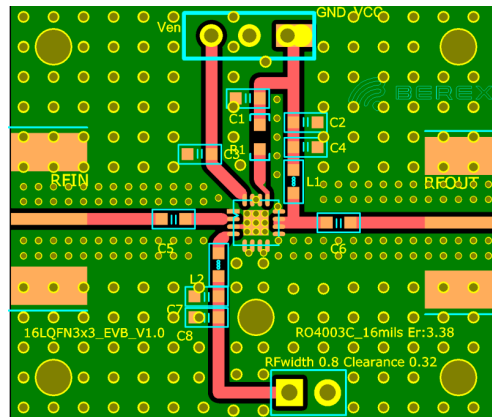

*Dielectric constant _ 3.38 *RF pattern width 0.8T *16mil thick RO4003PCB

Pin Configuration and Description

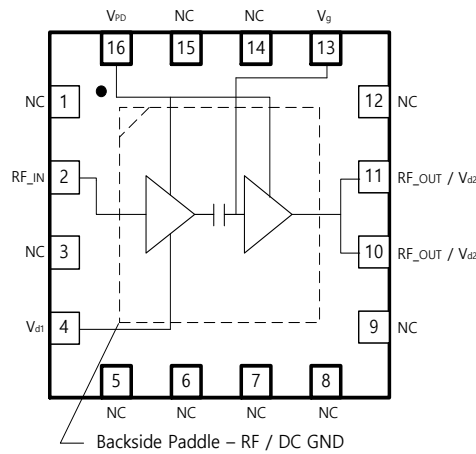

Pin No.	Name	Description
2	RF_IN	RFinput pin. A DC Block is required.
4	V _{d1}	Supply V _{d1} through choke/Inductor for the first stage of the device.
10,11	RF_OUT / V _{d2}	RFoutput / V _{d2} pin. Supply V _{d2} through choke/Inductor for the second stage of the device.
13	V _g	V _g sets I _{dq} through external resistor for V _d =5V or V _d =3.3V.
16	V _{PD}	Power on/off control pin. 0 ≤ V _{PD} ≤ 0.63V disables device. If function is not desired, Supply 1.17 ≤ V _{PD} ≤ V _d
1,3,5,6,7,8,9,12,14,15	NC	No internal connection to die. May be connected to ground.
Backside Paddle	RF /DC GND	Exposed Pad is RF/DC ground, must be soldered to PCB.

Typical Device Data

S-parameters ($V_d=5V, I_d=90mA, T=25^\circ C$)

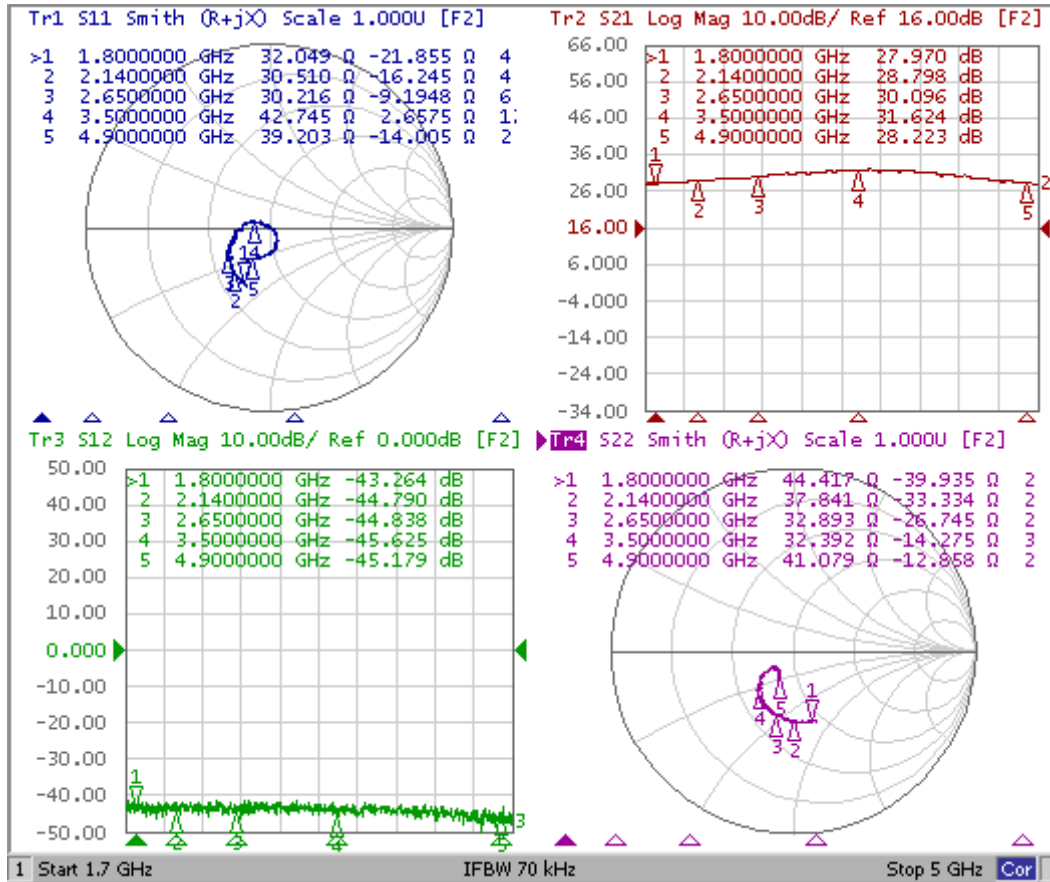

S-Parameter

($V_d = 5.0V, I_d = 90mA, T = 25^\circ C$, calibrated to device leads)

Freq [MHz]	S11 [Mag]	S11 [Ang]	S21 [Mag]	S21 [Ang]	S12 [Mag]	S12 [Ang]	S22 [Mag]	S22 [Ang]
	1700	0.337	-110.94	24.954	-23.825	0.006	24.006	0.399
2000	0.32	-123.904	26.967	-38.207	0.006	12.693	0.389	-83.733
2500	0.266	-142.954	30.435	-63.361	0.007	11.499	0.362	-100.432
3000	0.198	-162.89	35.963	-90.273	0.007	-5.321	0.337	-113.715
3500	0.089	162.418	38.504	-125.308	0.006	-22.48	0.283	-132.564
4000	0.033	-54.949	37.008	-160.249	0.007	-38.315	0.201	-141.521
4500	0.122	-83.949	30.702	168.485	0.005	-66.287	0.141	-134.333
5000	0.22	-123.301	24.639	140.468	0.004	-91.45	0.186	-117.132

Application Circuit: 1700~5000 MHz

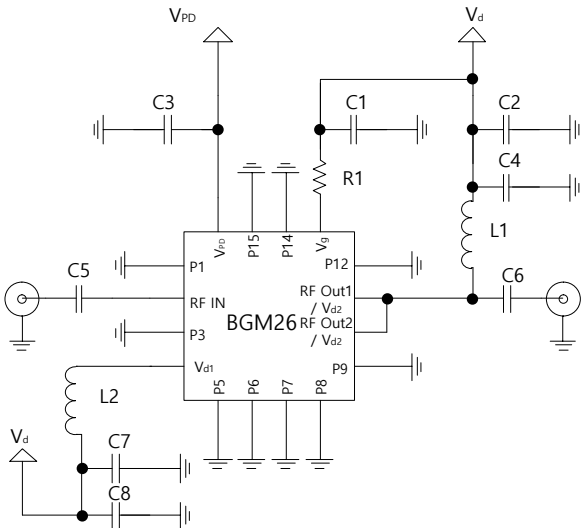
Schematic Diagram	BOM		Size
		C1	1nF
C2		1nF	1608
C3		NC	1608
C4		100pF	1608
C5		11pF	1608
C6		2pF	1608
C7		100pF	1608
C8		1nF	1608
L1		2.2nH	1608
L2		1nH	1608
R1		4.3Kohm	1608

* 3.3V R1 = 3Kohm

Typical Performance

$V_d = 5V, I_d = 90mA$

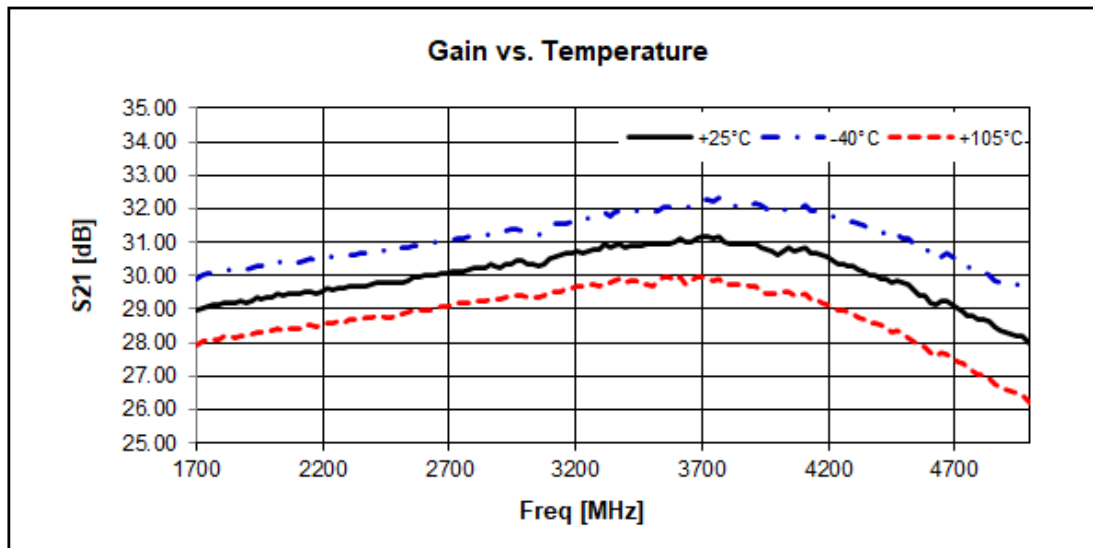

$V_d = 5V, I_d = 90mA$

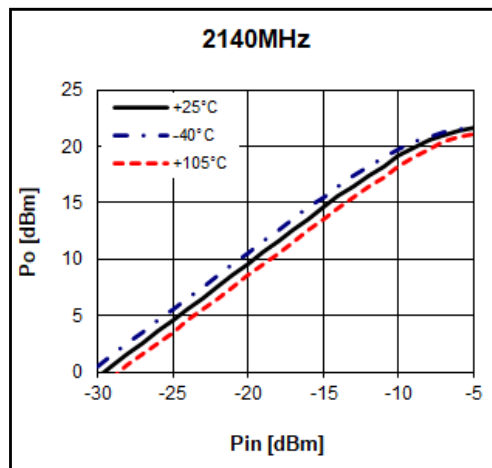
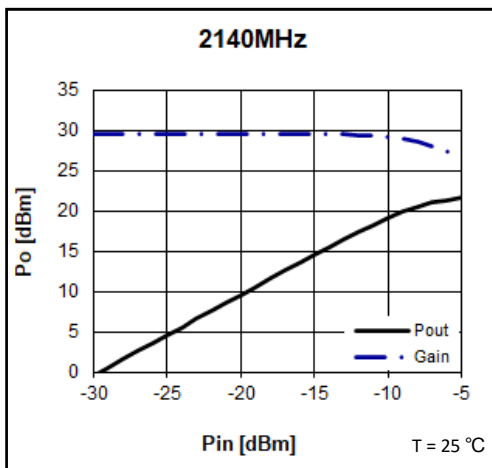
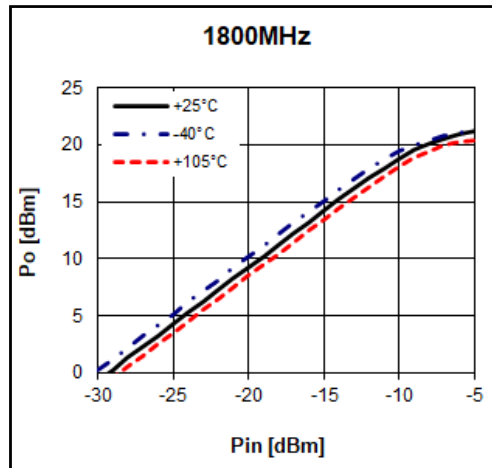
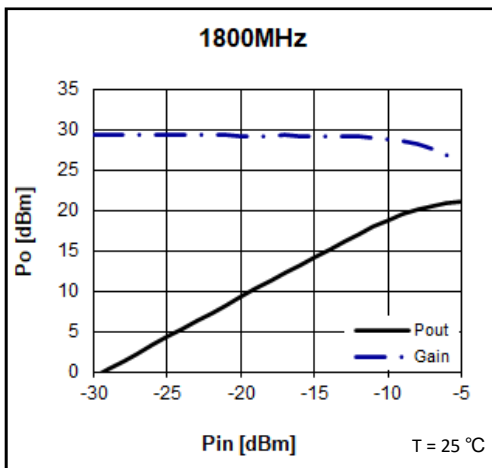
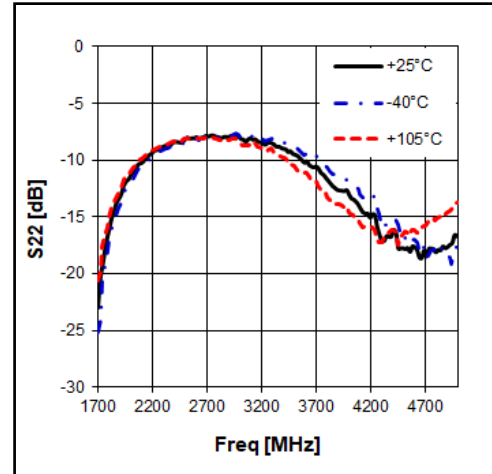
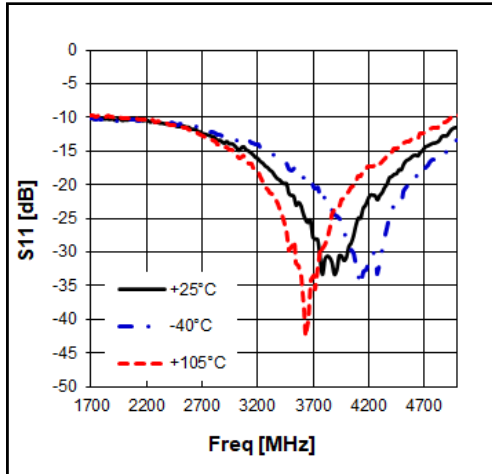

$V_d = 5V, I_d = 90mA$

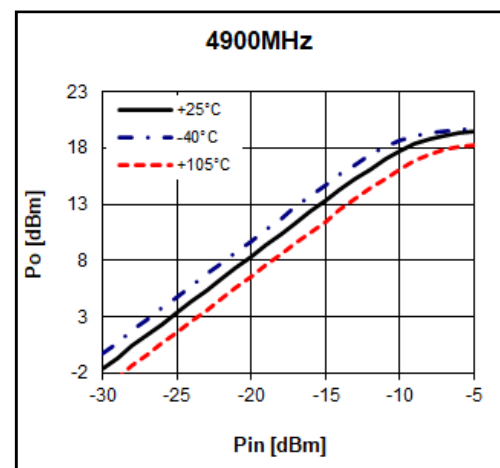
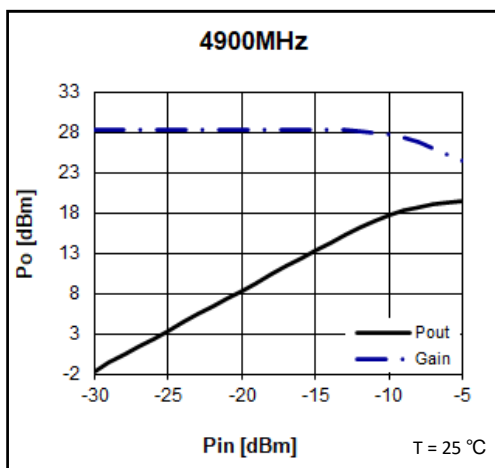
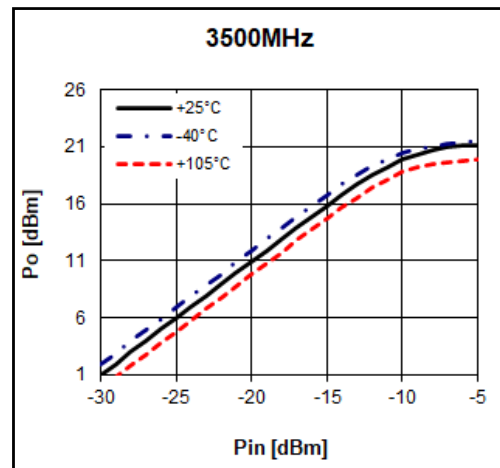
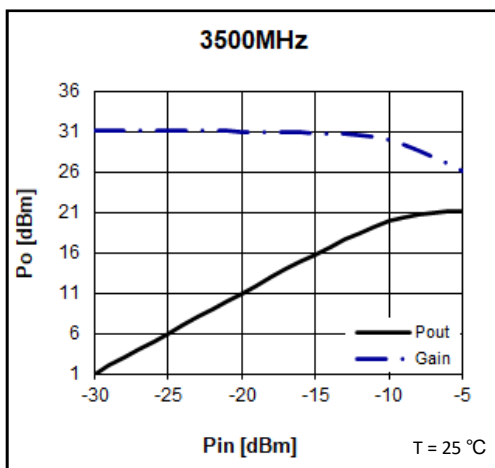
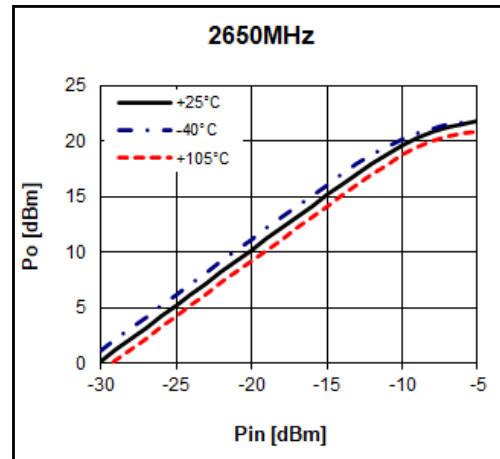
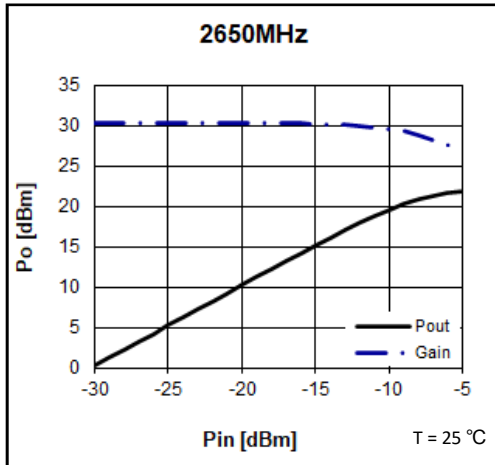

$V_d = 5V, I_d = 90mA$

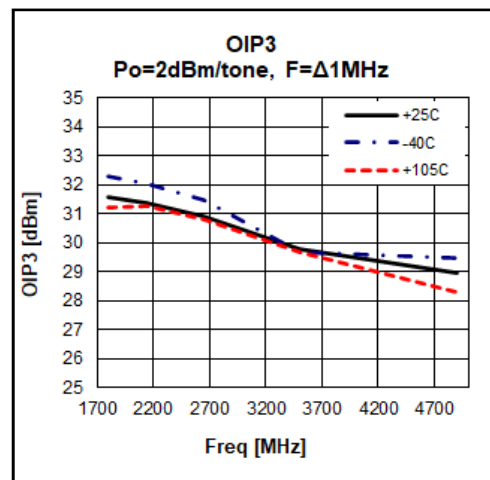
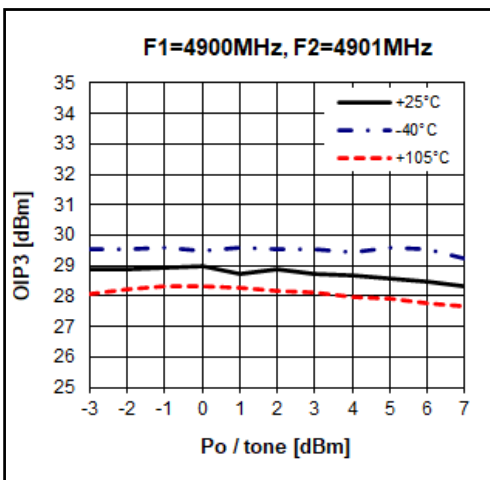
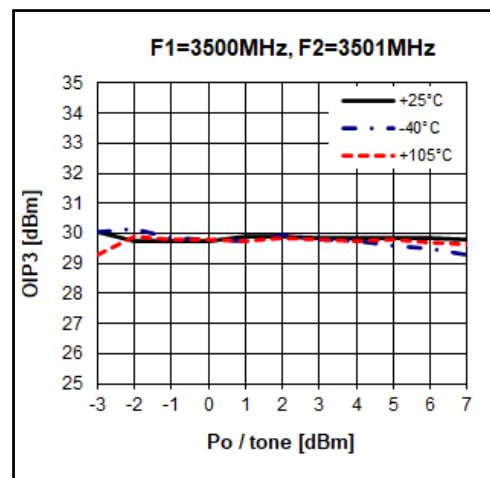
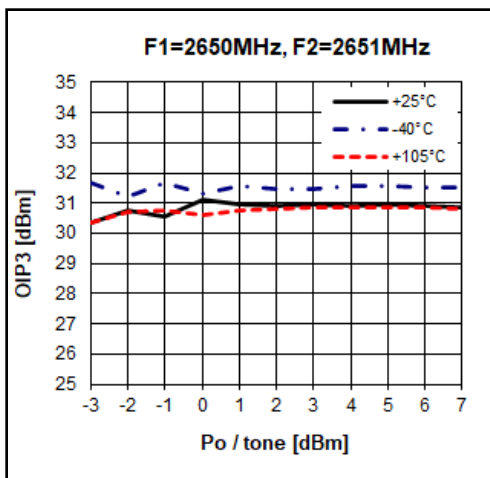
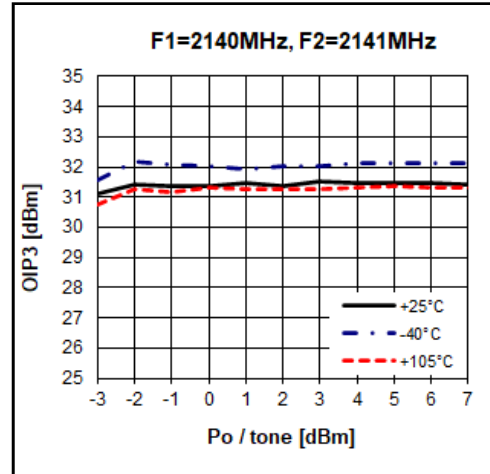
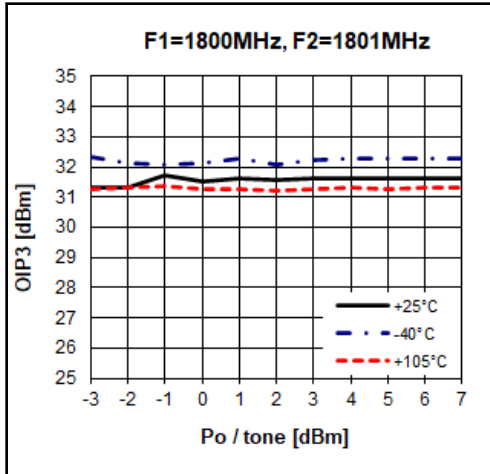

$V_d = 5V, I_d = 90mA$

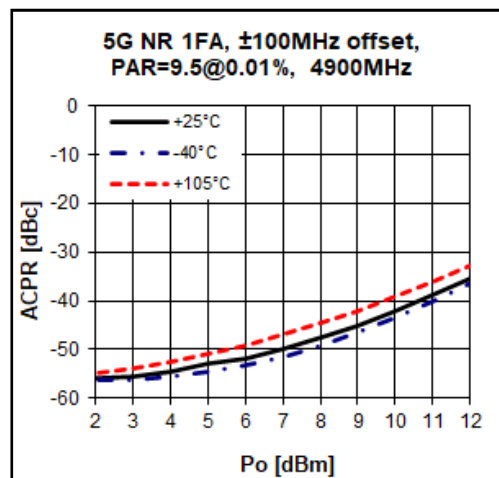
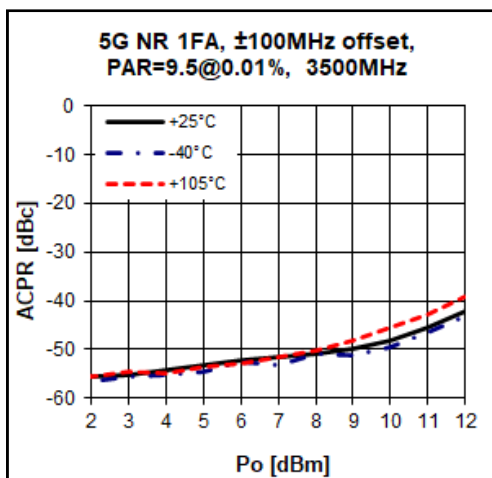
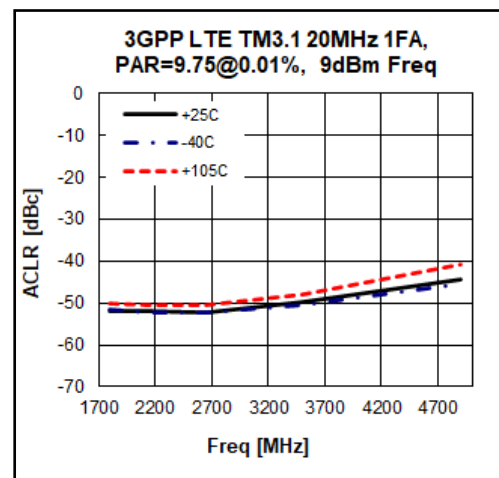
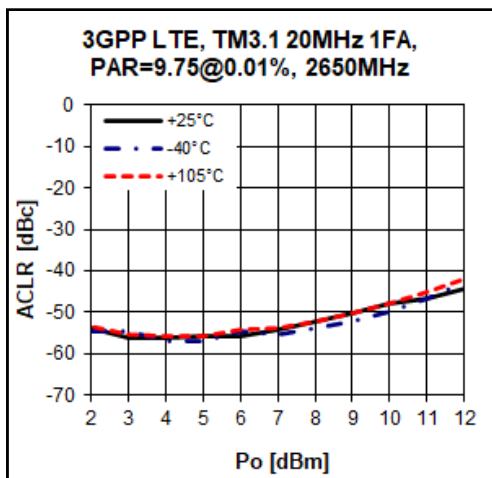
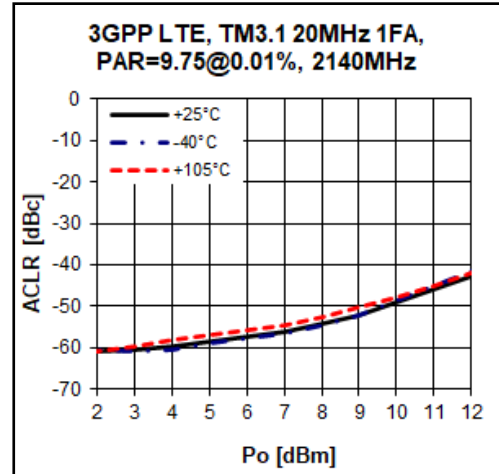
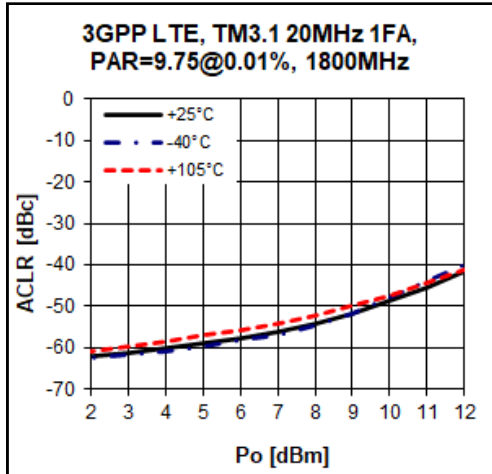

$V_d = 5V, I_d = 90mA$

3GPP 5G NR 1FA 3.5GHz (-50dBc) T = 25 °C

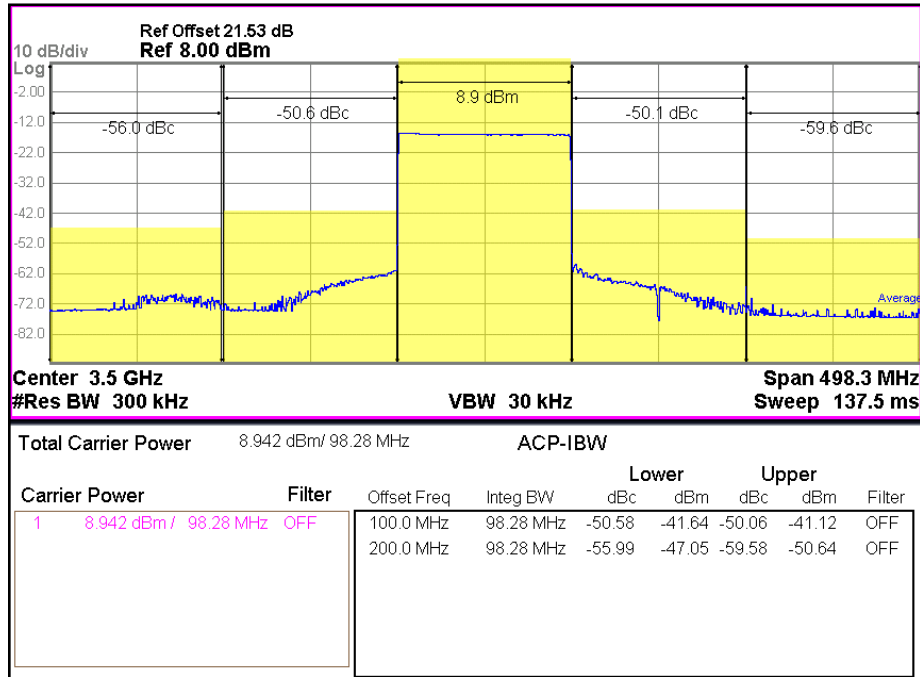

3GPP 5G NR 1FA 4.9GHz (-50dBc) T = 25 °C

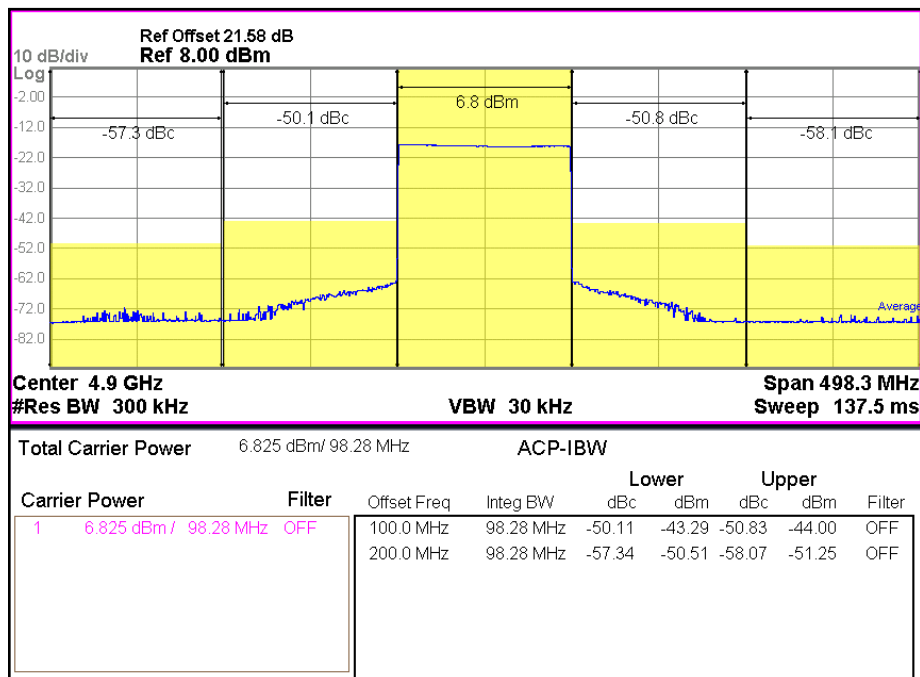

Package Outline Drawing

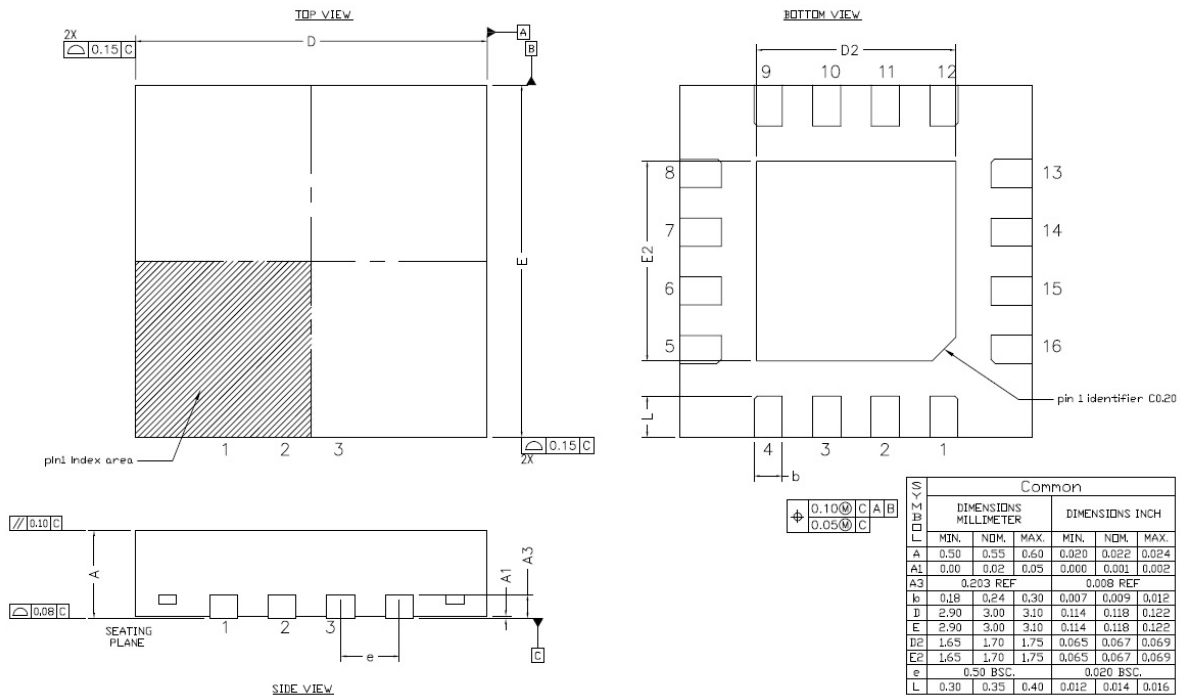

Note : All dimension _ millimeters

Suggested PCB Land Pattern and PAD Layout

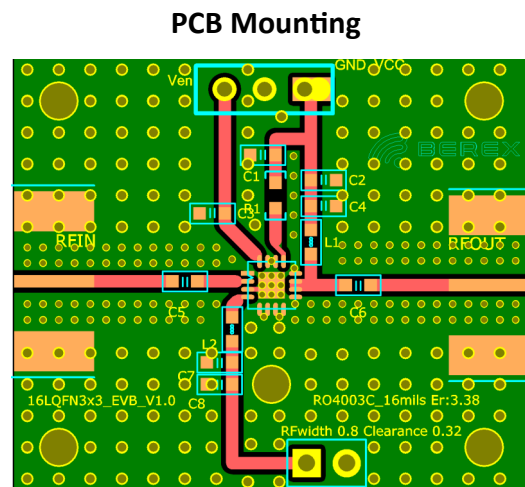
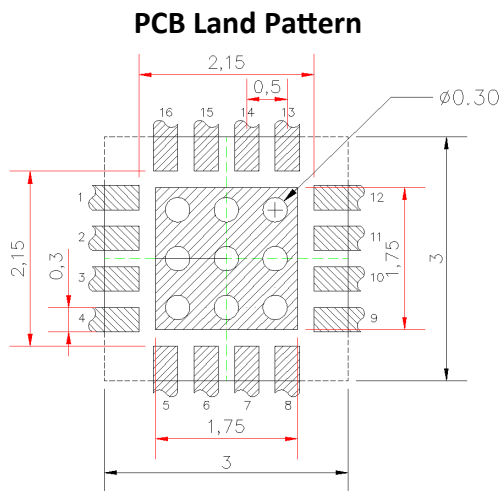

Note : All dimension _ millimeters

PCB lay out _ on BeRex website

Package Marking



YY = Year, WW = Working Week,
XX = Wafer No.

Pin 1

Tape & Reel

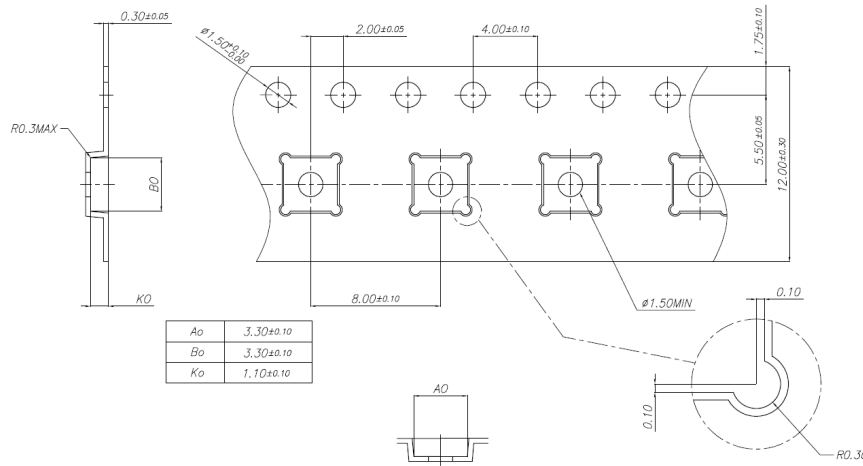

Packaging information:

Tape Width (mm): 8

Reel Size (inches): 7

Device Cavity Pitch (mm): 4

Devices Per Reel: 1000

Lead plating finish

100% Tin Matte finish

(All BeRex products undergoes a 1 hour, 150 degree C, Anneal bake to eliminate thin whisker growth concerns.)

MSL / ESD Rating

ESD Rating:	Class 1B
Value:	Passes <1000V
Test:	Human Body Model (HBM)
Standard:	JEDEC Standard JS-001-2017
MSL Rating:	Level 1 at +260°C convection reflow
Standard:	JEDEC Standard J-STD-020



Proper ESD procedures should be followed when handling this device.

RoHS Compliance

This part is compliant with Restrictions on the Use of Certain Hazardous Substances in Electrical and Electronic Equipment (RoHS) Directive 2011/65/EU as amended by Directive 2015/863/EU.

This product also is compliant with a concentration of the Substances of Very High Concern (SVHC) candidate list which are contained in a quantity of less than 0.1%(w/w) in each components of a product and/or its packaging placed on the European Community market by the BeRex and Suppliers.

NATO CAGE code:

2	N	9	6	F
---	---	---	---	---