

**FERROXCUBE**

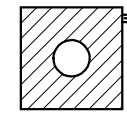

c



d

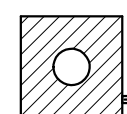

e

f

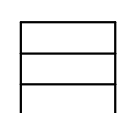

1

2

3

4

5

6

7

8

a

b

c

d

e

f

a

b

c

d

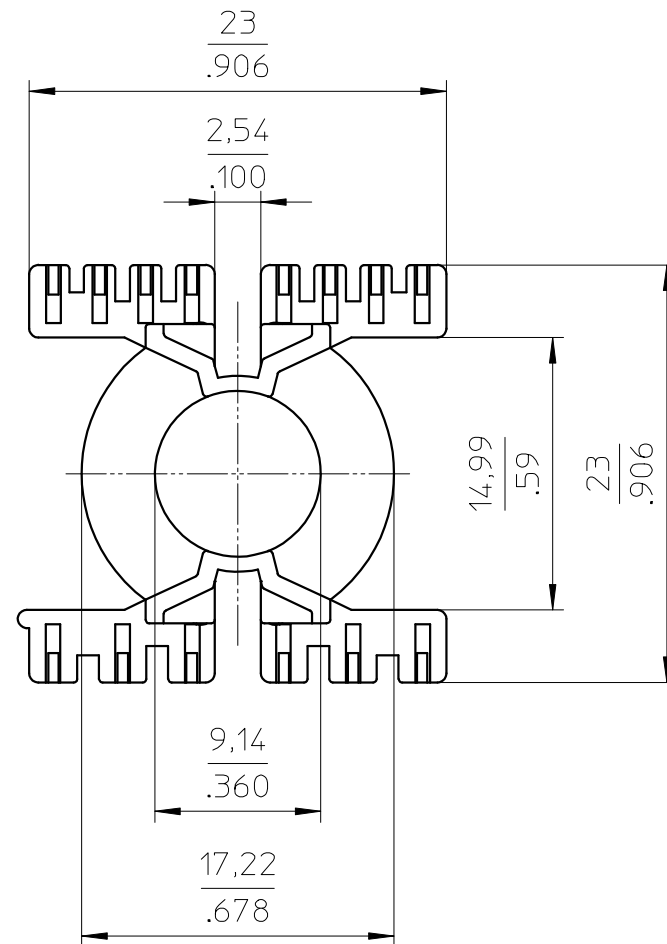
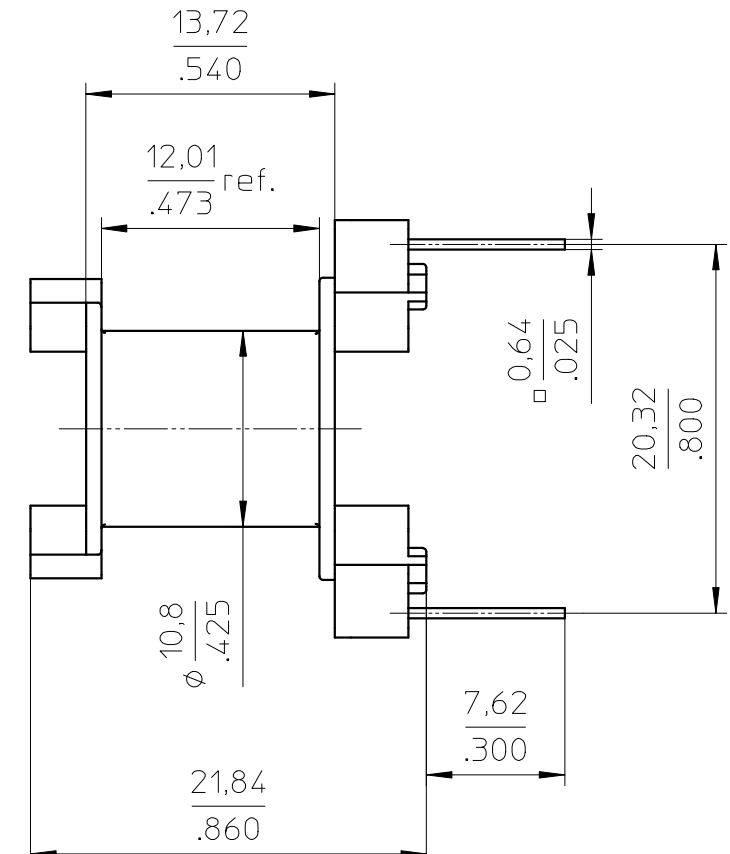
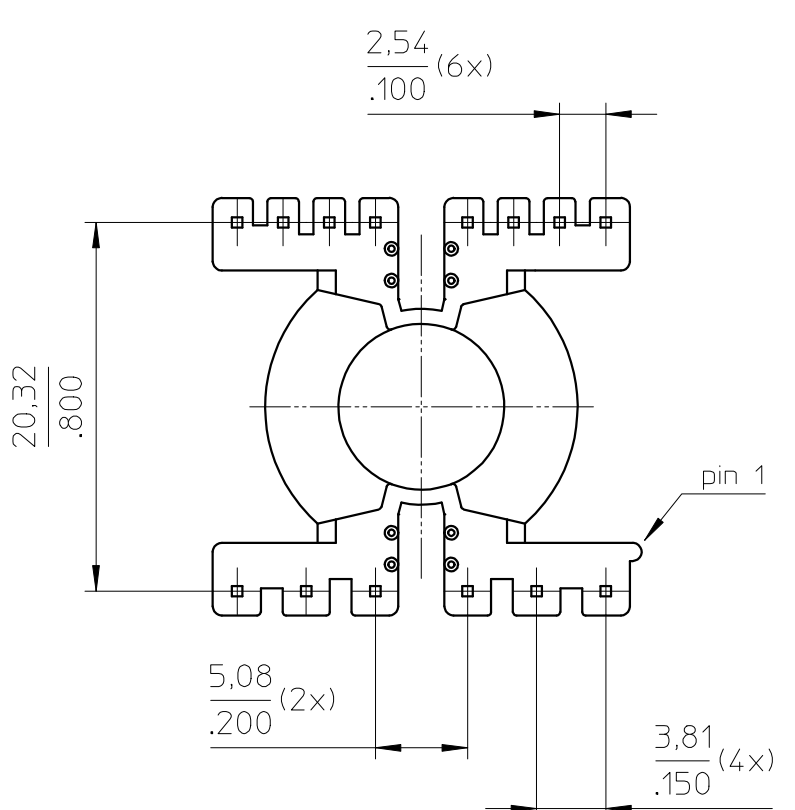

Grid pattern

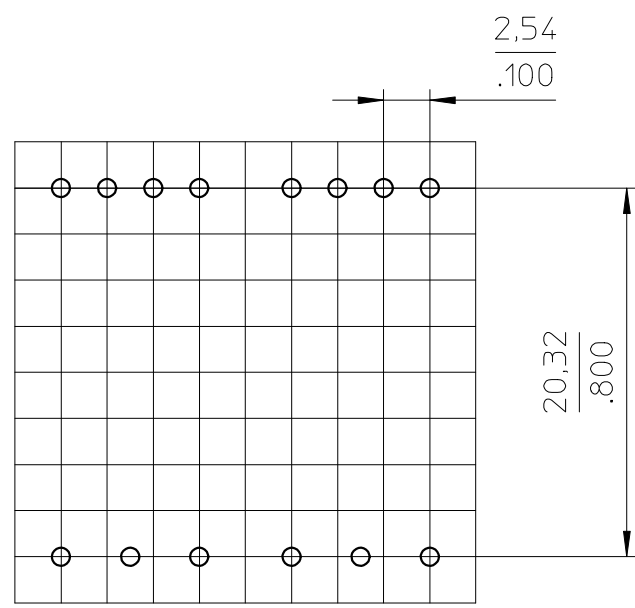

Coil former material: Rynite FR530 (PET), glass-reinforced, (color black).  
 UL file number: E41938 - UL94V-0.  
 max. operating temp: 180°C, class H  
 pin material: Copper-plated steel wire, Sn plated.  
 solderability: acc. to IEC 60068-2-20 part2, Test Ta method 1, 235C-2sec.  
 mean length of turn: 1.733 inch  
 winding area: 0.06 sq. inch.

CLASS.NO.	CPV-PQ20/20-1S-14P-Z		4335 060 26731	06-02-22
NAME NAAM	A.Wojtasz	SUPERS. VERV.	SH SH BL BL	A3
MPA	CHECK CONTR.	DAT.	Property of Eigendom van	© FERROXCUBE 2000
		06-02-22		