

# DS2483 Evaluation System

## Evaluates: DS2483

### General Description

The DS2483 evaluation system (EV system) consists of a DS2483 evaluation kit (EV kit) and a DS9400 USB-to-I<sup>2</sup>C adapter. The DS2483 is an I<sup>2</sup>C-to-1-Wire bridge device that performs protocol conversion from an I<sup>2</sup>C Master to any attached 1-Wire slave device. Relative to any attached 1-Wire slave device, the DS2483 is a 1-Wire master. The evaluation software runs under a Windows® 7 or Windows XP® operating system (OS), providing a handy user interface to exercise the features of the DS2483.

Order the DS2483K# for the complete EV system to evaluate the DS2483 using a PC. Evaluation software for the EV system is also available on our website at: [www.maximintegrated.com/evkit](http://www.maximintegrated.com/evkit).

### Features

- ◆ I<sup>2</sup>C Host Interface Supports 100kHz and 400kHz I<sup>2</sup>C Communication Speeds
- ◆ I<sup>2</sup>C Operating Voltages: 1.8V ±5% and 3.3V ±5%
- ◆ 1-Wire Operating Voltage: 1.8V ±5% and 3.3V ±5%
- ◆ EV Kit Contains a Mounted 6-Pin SOT23 DS2483R+T IC
- ◆ Convenient On-Board Test Points and TO-92 Socket
- ◆ Standard RJ11 Connector Interfaces to DS9120 Socket Boards
- ◆ Downloadable Evaluation Software

*Ordering Information appears at end of data sheet.*

### EV System Contents

QTY	DESCRIPTION
1	DS2483 Evaluation Board
1	DS9400 USB-to-I <sup>2</sup> C Adapter Maxim DS9400#

QTY	DESCRIPTION
1	USB Type A to USB Mini Type B Cable Qualtek 3021003-03
1	1024-Bit 1-Wire EEPROM (3 TO-92) Maxim DS2431+

### DS2483 Evaluation Kit Board

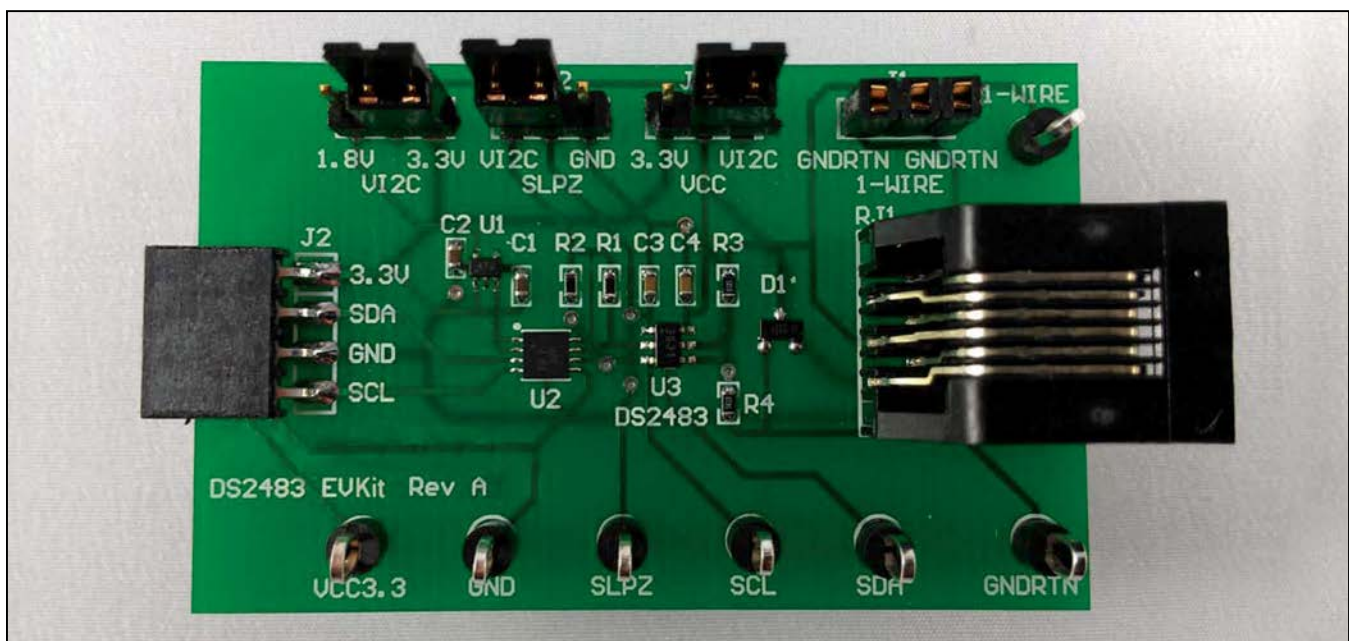

*Windows and Windows XP are registered trademarks of Microsoft Corp.*

**For pricing, delivery, and ordering information, please contact Maxim Direct at 1-888-629-4642, or visit Maxim's website at [www.maximintegrated.com](http://www.maximintegrated.com).**

# DS2483 Evaluation System

## Evaluates: DS2483

### Component List

DESIGNATION	QTY	DESCRIPTION
C1, C2	2	1 $\mu$ F $\pm$ 10%, 10V ceramic capacitors (0603) TDK Corporation C1608X5R1A105K
C3, C4	2	0.1 $\mu$ F $\pm$ 10%, 16V X7R ceramic capacitors (0603) KEMET C0603C104K4RACTU
D1	1	Zener diode Fairchild Semiconductor BZX84C5V6
J1	1	3-position connector socket strip LOPRO Samtec SSA-132-S-G
J2	1	4-pin 100-mil female connector Samtec SSQ-104-02-T-S-RA
JP1, JP2, JP3	3	0.100, 3-position vertical 0.318 breakaway headers Tyco Electronics 9-146276-0
R1, R2	2	3.3k $\Omega$ $\pm$ 1% resistors (0603) Yageo RC0603FR-073K3L

DESIGNATION	QTY	DESCRIPTION
R3, R4	2	5.11 $\Omega$ $\pm$ 1% resistors (0603) Panasonic ERJ-8GEYJ5R1V
RJ1	1	Connector mod jack, 6-6 PCB 50AU Tyco Electronics 5555165-1
TP1-TP7	7	Test points Keystone Electronics 5011
U1	1	High PSRR, low-dropout, 150mA linear regulator (5 SC70) Maxim MAX8891EXK18+
U2	1	Dual-channel level translator (8 TDFN-EP*) Maxim MAX3394EETA+T
U3	1	I <sup>2</sup> C-to-1-Wire Master (6 SOT23) Maxim DS2483R+T
—	3	LP with handle, 2-position shunt, 30AU TE Connectivity 881545-2
—	1	PCB: DS2483 EVKit Rev A

\*EP = Exposed pad.

### DS2483 Evaluation System

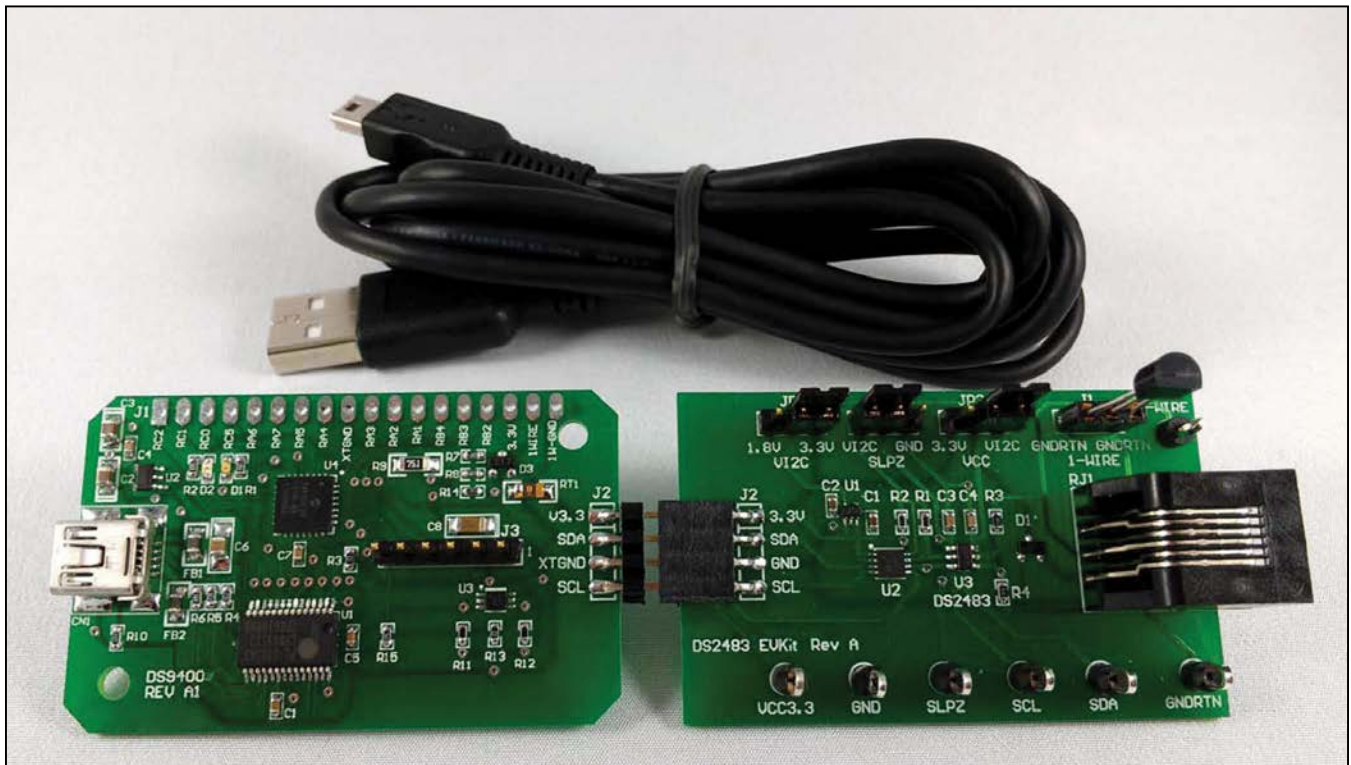

# DS2483 Evaluation System

## Evaluates: DS2483

### Quick Start

#### Recommended Equipment

- Maxim DS9400 EV kit (included)
- DS2483 EV kit (included)
- USB Type A to USB Mini Type B cable (included)
- DS2431+ (included)
- PC with a Windows 7, Windows Vista®, or Windows XP OS and a spare USB port

**Note:** In the following sections, software-related items are identified by bolding. Text in **bold** refers to items directly from the EV kit software. Text in **bold and underlined** refers to items from the Windows OS.

#### Procedure

- 1) a) Do the following to install PL-2303 Prolific Driver:  
Download the driver file called **PL2303\_Prolific\_DriverInstaller\_v1.4.17.ZIP** or newer from <http://prolificusa.com/pl-2303hx-drivers>.  
**Open** and **Run** the file with the name or newer version **PL2303\_Prolific\_DriverInstaller\_v1417.EXE**.  
b) Follow the directions of the **Install Wizard** until **Finish** is reached of the PL-2303 USB-to-serial driver install. Close by clicking the **Finish** button.
- 2) The DS9400 USB-to-I<sup>2</sup>C adapter uses both the Prolific PL-2303HXD and a microcontroller to provide an I<sup>2</sup>C port on any computer. Verify correct installation of the

virtual COM port by inserting the DS9400 into a spare USB port on the computer. Check the COM port by looking in **Control Panel|System|Device Manager** and expand **Ports (COM & LPT)**. If the driver installed correctly, the driver should display as in the example shown in [Figure 1](#). Note that your COM port number may be different.

You have now completed the installation of the DS9400 adapter.

- 3) Proceed now by setting up the DS2483 EV kit hardware by doing the following:
  - a) Set the jumpers per Figure 16 for 3.3V operation for both the I<sup>2</sup>C I/F and 1-Wire.
  - b) Insert the DS2431 device into J1 of the DS2483 EV kit.
  - c) Plug the J2 of the DS9400 adapter into J2 of the DS2483 EV kit.
- 4) Now download the **DS2483 EVKit Software** from [www.maximintegrated.com/evkit](http://www.maximintegrated.com/evkit).
- 5) Unzip the **DS2483 EVKIT.ZIP** in a known location.
- 6) Open the **DS2483 EVKIT** folder and double-click the **Setup.EXE**. If you encounter the dialog box shown in [Figure 2](#), click the **Cancel** button. When prompted by the window as shown in [Figure 3](#), click **Install**.
- 7) The DS2483 EV kit software detects if the PC has the required .NET Framework 2.0 files. If the files do not exist, the program prompts to download them from the web. Otherwise, the program will install and display the **DS2483 EVKIT** main page (Figure 4).

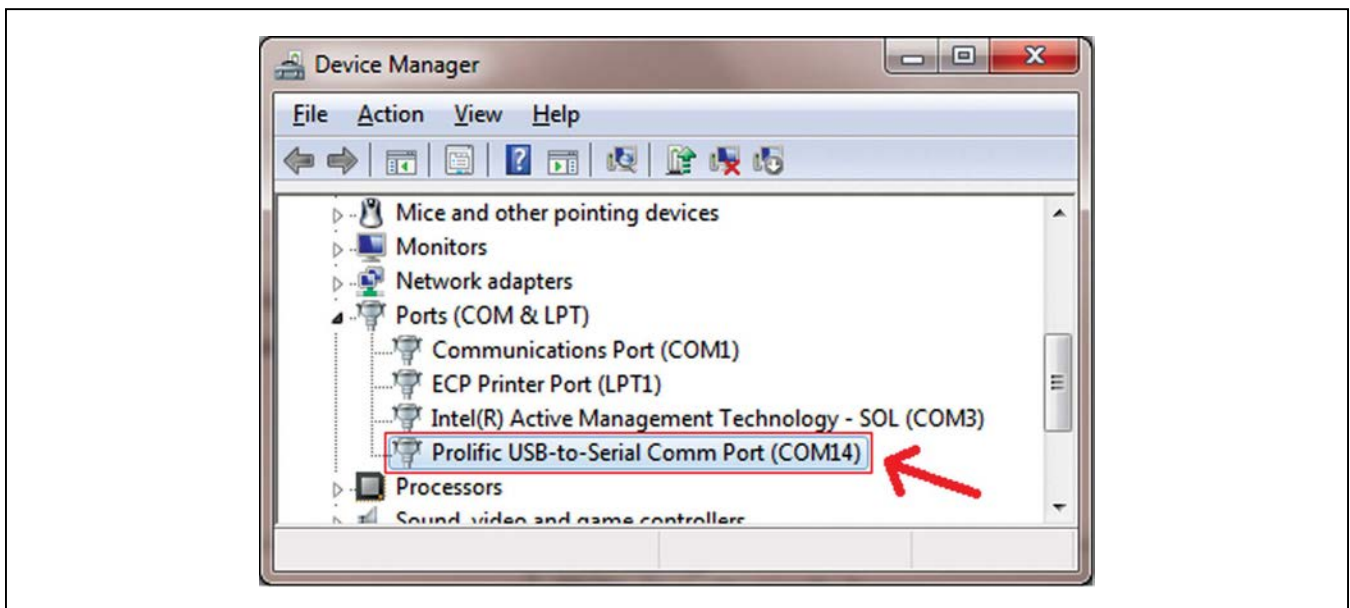

Figure 1. DS9400 COM Port

Windows Vista is a registered trademark of Microsoft Corp.

# DS2483 Evaluation System Evaluates: DS2483

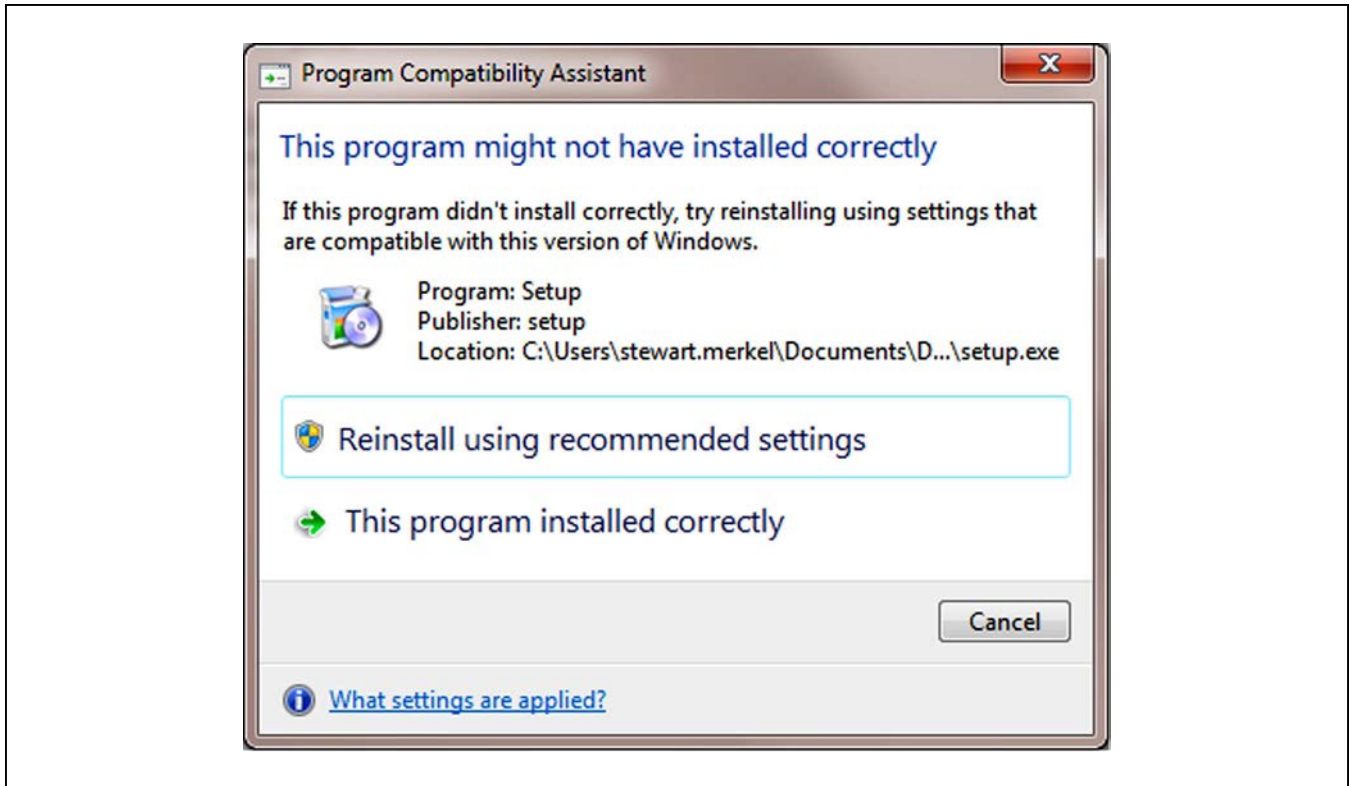

Figure 2. Program Compatibility Assistant

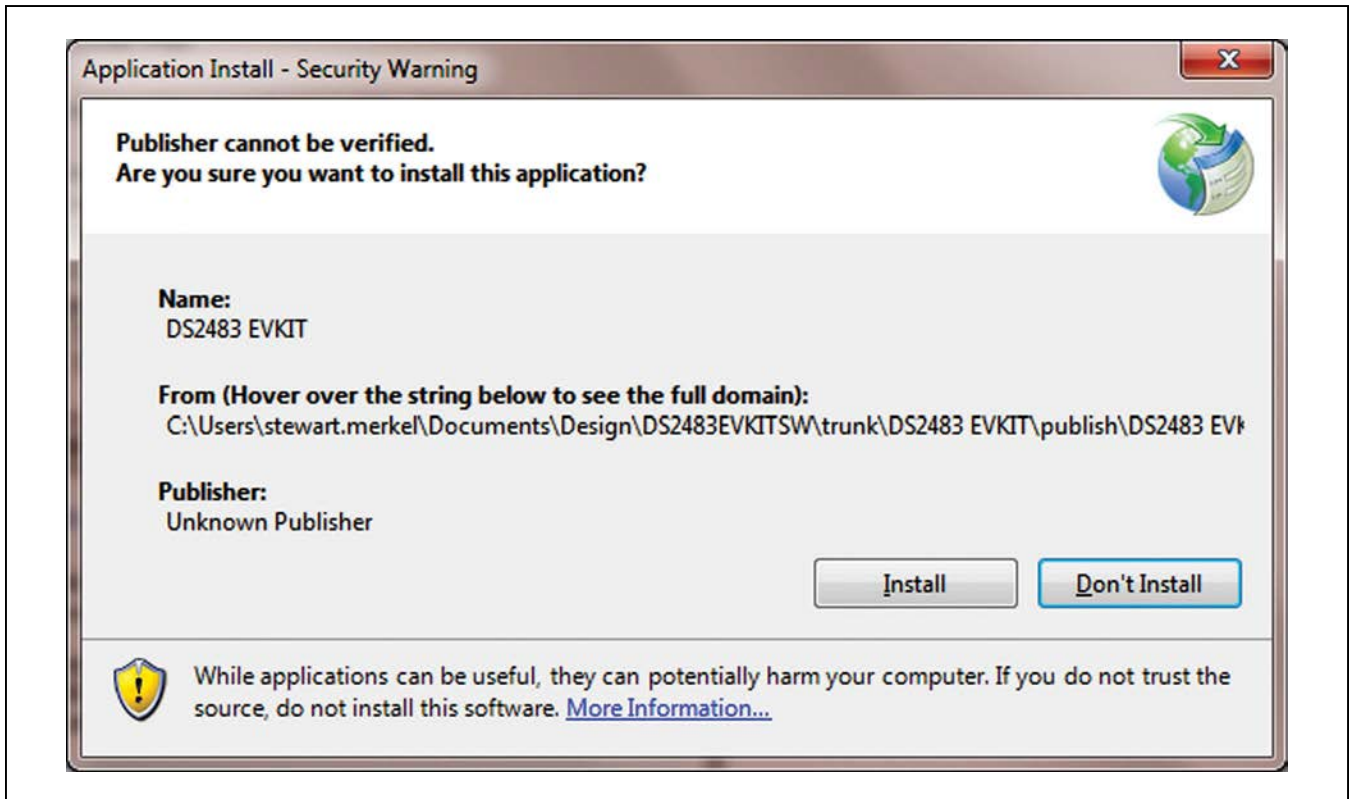

Figure 3. Application Install – Security Warning

# DS2483 Evaluation System

## Evaluates: DS2483

### Detailed Description of Software

Figure 4 shows the evaluation software's main window. This window consists of three main tabs: **DS2483**, **1-Wire Sequences**, and **Error Log**. The **I2C Data Log** and the **1-Wire Data Log** group boxes are shown regardless

of which tab is selected and display communication activity. These two group boxes assist the engineer in becoming familiar with what command sequences the DS2483 device needs in order to function. A mini tool bar provides additional functionality for both the software and the DS2483 device.

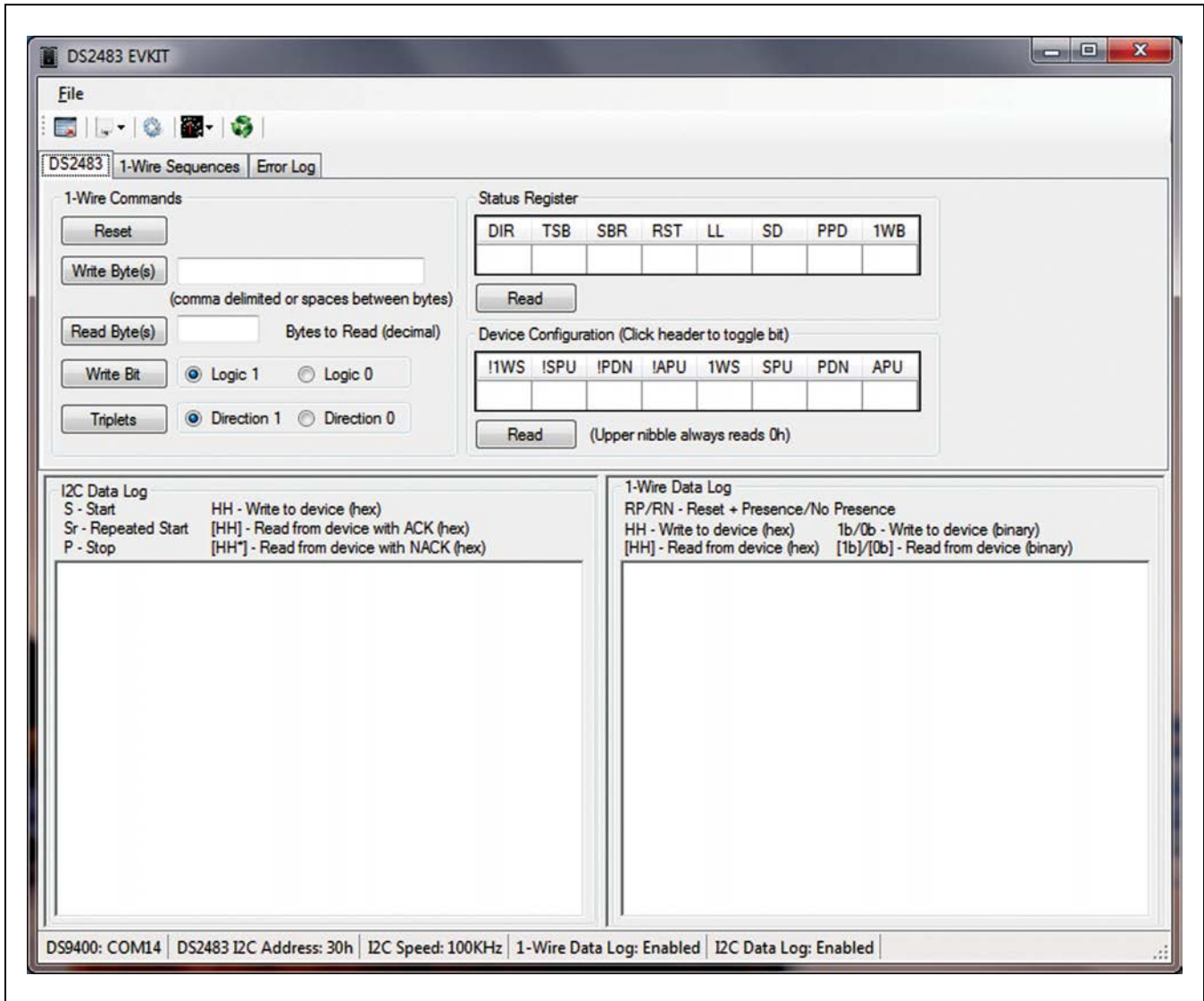

Figure 4. DS2483 EVKIT Main Window

# DS2483 Evaluation System

## Evaluates: DS2483

### Viewer Window Areas DS2483 Tab

The **1-Wire Commands** group box (Figure 5) allows the user to send **1-Wire commands** to any 1-Wire slave device. The following features are supported in the **1-Wire Commands** group box:

- **Reset:** This sends a 1-Wire Reset command on the 1-Wire bus.
- **Write Byte(s):** Writes any number of 1-Wire bytes on the 1-Wire bus up to 16,382 bytes (no spaces or commas).

- **Read Byte(s):** Reads any number of 1-Wire time-slot bytes on the 1-Wire bus up to 32,768 bytes.
- **Write Bit:** Writes a 1-Wire single bit with a value of 0 or 1 dependent on if **Logic 1** or **Logic 0** is selected to the 1-Wire bus.
- **Triplets:** Writes a single triplet with a branch direction of 0 or 1 dependent on if **Direction 1** or **Direction 0** is selected to the 1-Wire bus. This function assists in performing a Search ROM function on a 1-Wire bus.

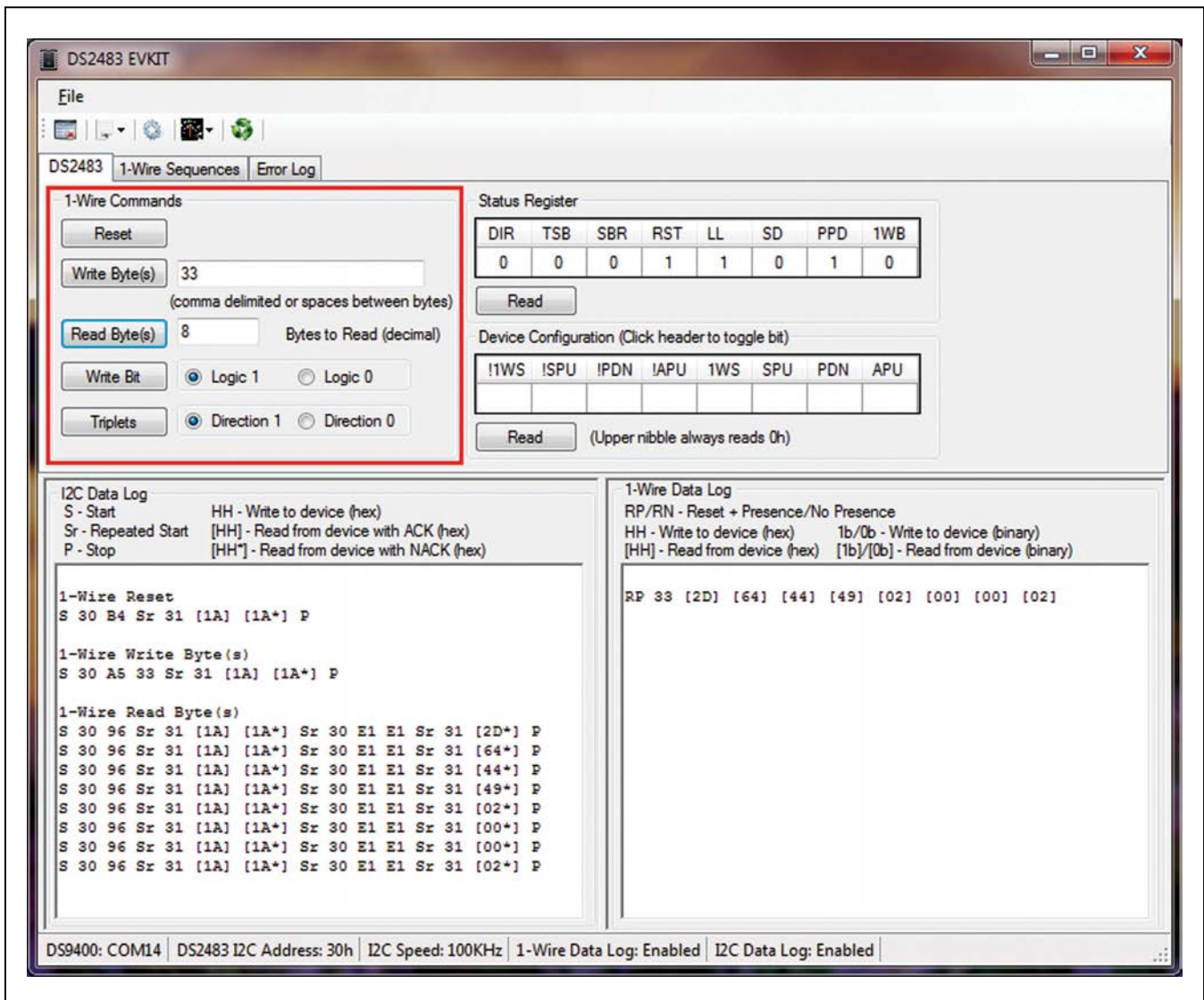

Figure 5. 1-Wire Commands Group Box

# DS2483 Evaluation System

## Evaluates: DS2483

The **Status Register** group box (Figure 6) provides access to the DS2483's Status register bits. A **Read** performs a read of the Status register bits by the I<sup>2</sup>C interface. This is a read-only register. The software

application automatically updates the contents when a command alters any of the bits in the **Status Register** group box.

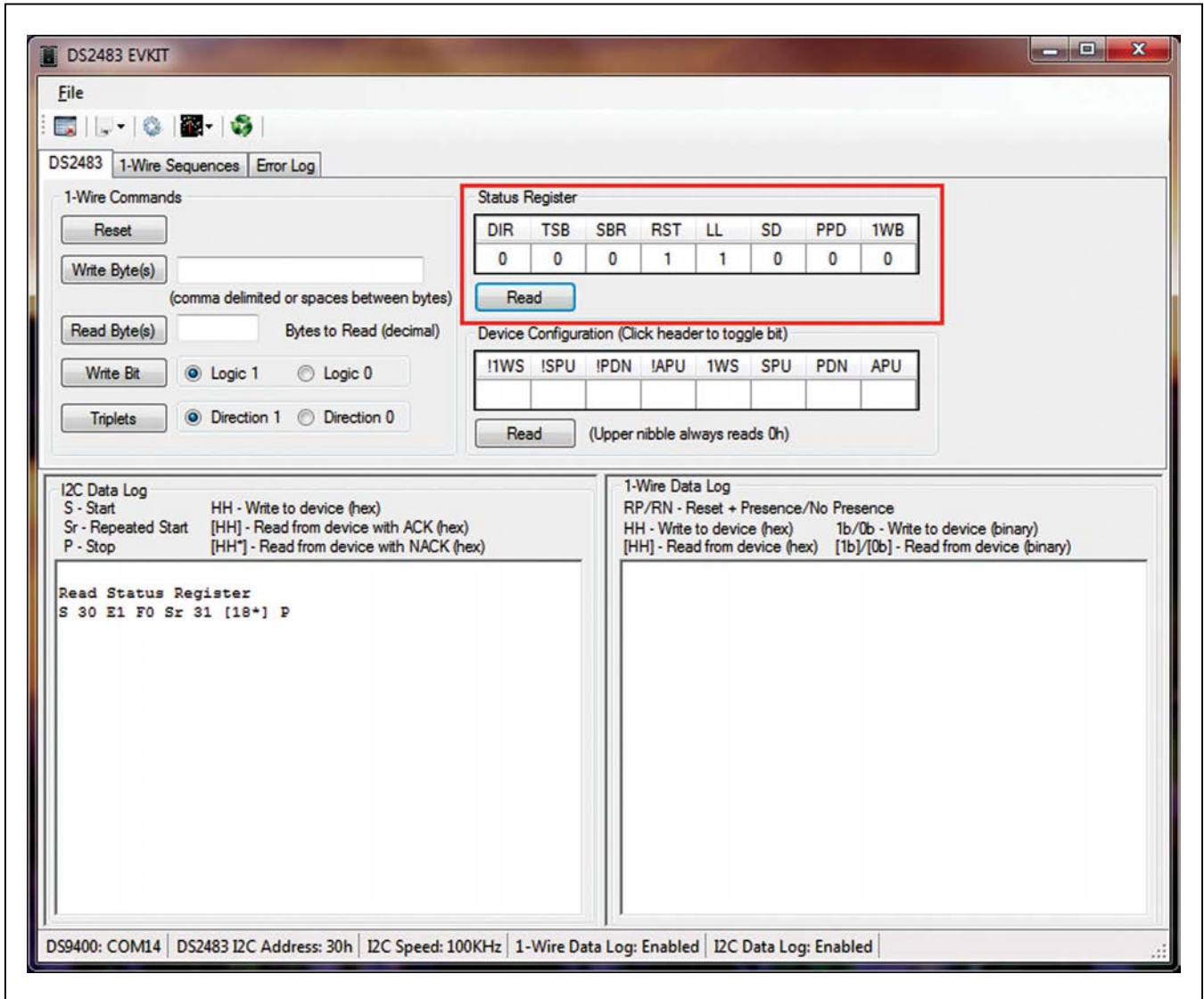

Figure 6. Status Register Group Box

# DS2483 Evaluation System

## Evaluates: DS2483

The **Device Configuration** group box (Figure 7) provides access to the DS2483's Configuration register bits. A Read performs a **read** of the Device Configuration register bits. The upper nibble always reads 0h. Click on the header bit label to toggle the particular bit. When writing to the Device Configuration register, the new

data is accepted only if the upper nibble (bits 7:4) is the one's complement of the lower nibble (bits 3:0). Therefore, when a bit on the lower nibble is selected, the upper nibble bit with the same label and invert symbol (!) automatically shows as the one's complement. However, when reading the register, the upper nibble reads 0h.

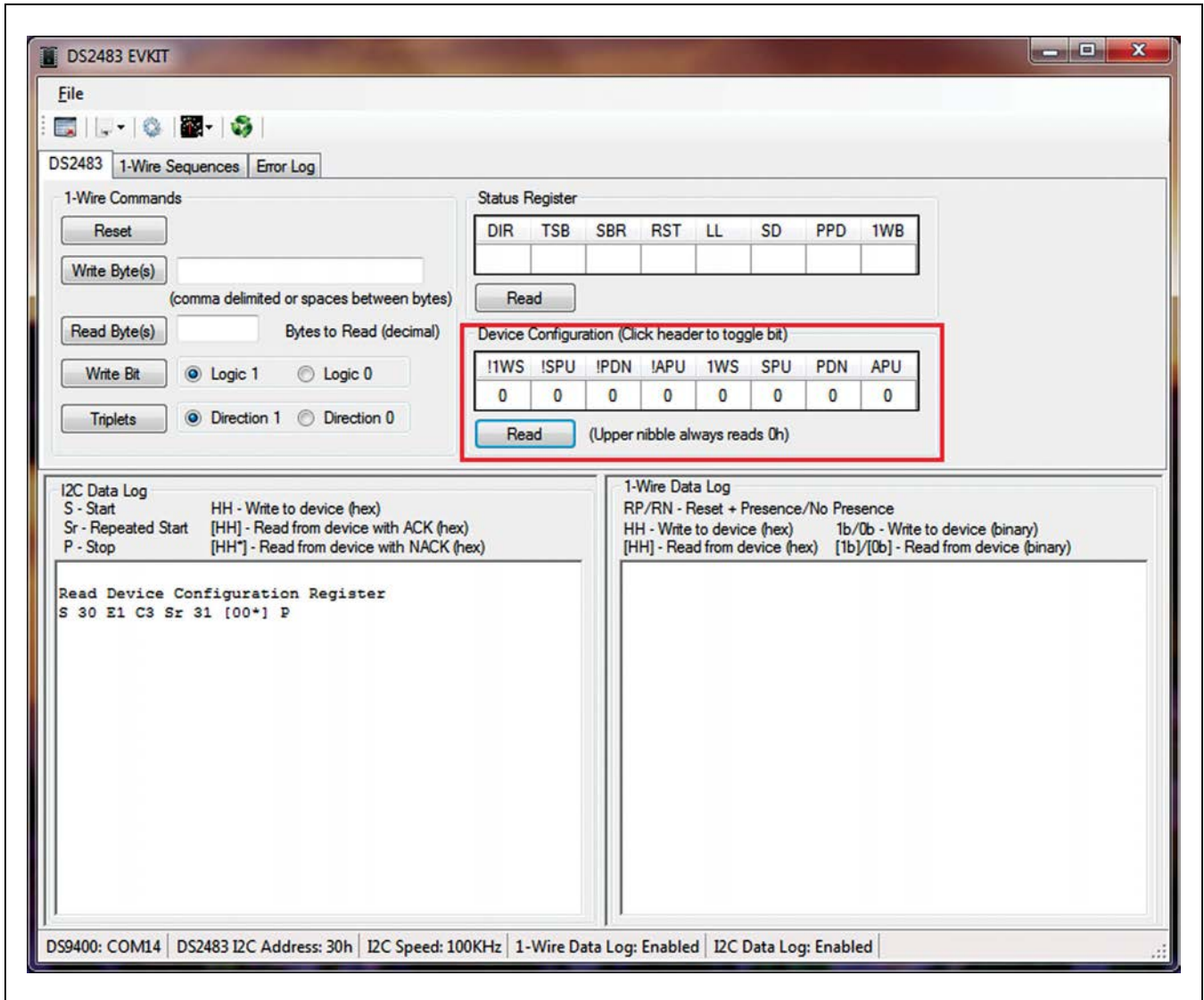

Figure 7. Device Configuration Group Box



# DS2483 Evaluation System

## Evaluates: DS2483

### 1-Wire Sequences Tab

The **Single Slave** group box (Figure 8) allows the user to send 1-Wire command sequences to any 1-Wire slave device. Using these commands with multiple slaves on the line may cause corruption (logical ANDing of bits). The following features are supported in the **Single Slave** group box:

- **Read ROM:** Sends a 1-Wire Reset command, Read ROM (33h) command followed by reading 8 bytes on

the 1-Wire bus. The ROM ID is then displayed and the CRC is verified.

- **Skip ROM:** Sends a 1-Wire Reset command followed by a Skip ROM (CCh) command on the 1-Wire bus. This is used to select a single 1-Wire slave device.
- **OD Skip ROM:** Sends a 1-Wire Reset command followed by an OD Skip ROM (3Ch) command on the Wire bus. This is used to place a single or all the 1-Wire slave devices on the 1-Wire bus into overdrive mode.

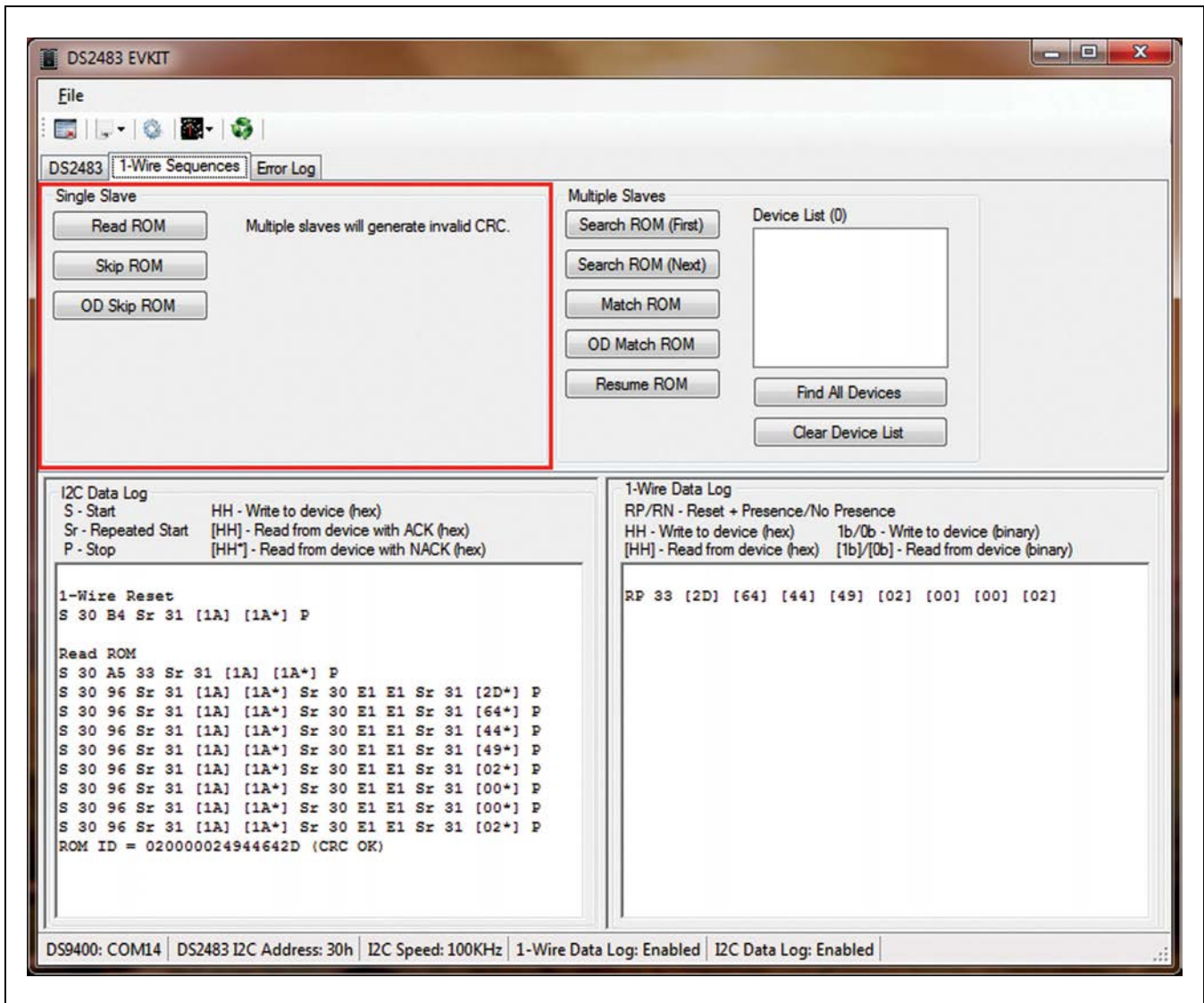

Figure 8. Single Slave Group Box



# DS2483 Evaluation System

## Evaluates: DS2483

### Log Group Boxes

The log group boxes provide all the outputs of the I<sup>2</sup>C bus and the 1-Wire bus. These logs can each be highlighted and copied to the clipboard for pasting into any windows program.

The **I<sup>2</sup>C Data Log** (Figure 10) allows the user to view all the I<sup>2</sup>C traffic transmitted and received from the I<sup>2</sup>C bus. This can assist the designer determining what I<sup>2</sup>C command sequences are needed to exercise the DS2483 device. The **I<sup>2</sup>C Data Log** displays the characters shown in Table 1.

**Table 1. I<sup>2</sup>C Communication Key**

KEY	FUNCTION
<b>S - Start</b>	I <sup>2</sup> C START command represented by a single "S" in a line.
<b>Sr - Repeated Start</b>	I <sup>2</sup> C repeated START command represented by "Sr" in a line.
<b>P - Stop</b>	I <sup>2</sup> C STOP command represented by a single "P" in a line.
<b>HH - Write to device (hex)</b>	I <sup>2</sup> C write from master to device represented by a pair of hex digits showing the byte that was transmitted.
<b>[HH] - Read from device with ACK (hex)</b>	I <sup>2</sup> C read from device represented by a pair of hex digits bounded by brackets "[ ]" showing that the byte that was received. This byte was ACKed by the master.
<b>[HH*] - Read from device with NACK (hex)</b>	I <sup>2</sup> C read from device represented by a pair of hex digits and an asterisk "*" bounded by brackets "[ ]" showing the byte that was received. This byte was NACKed by the master indicated that the master is done reading.

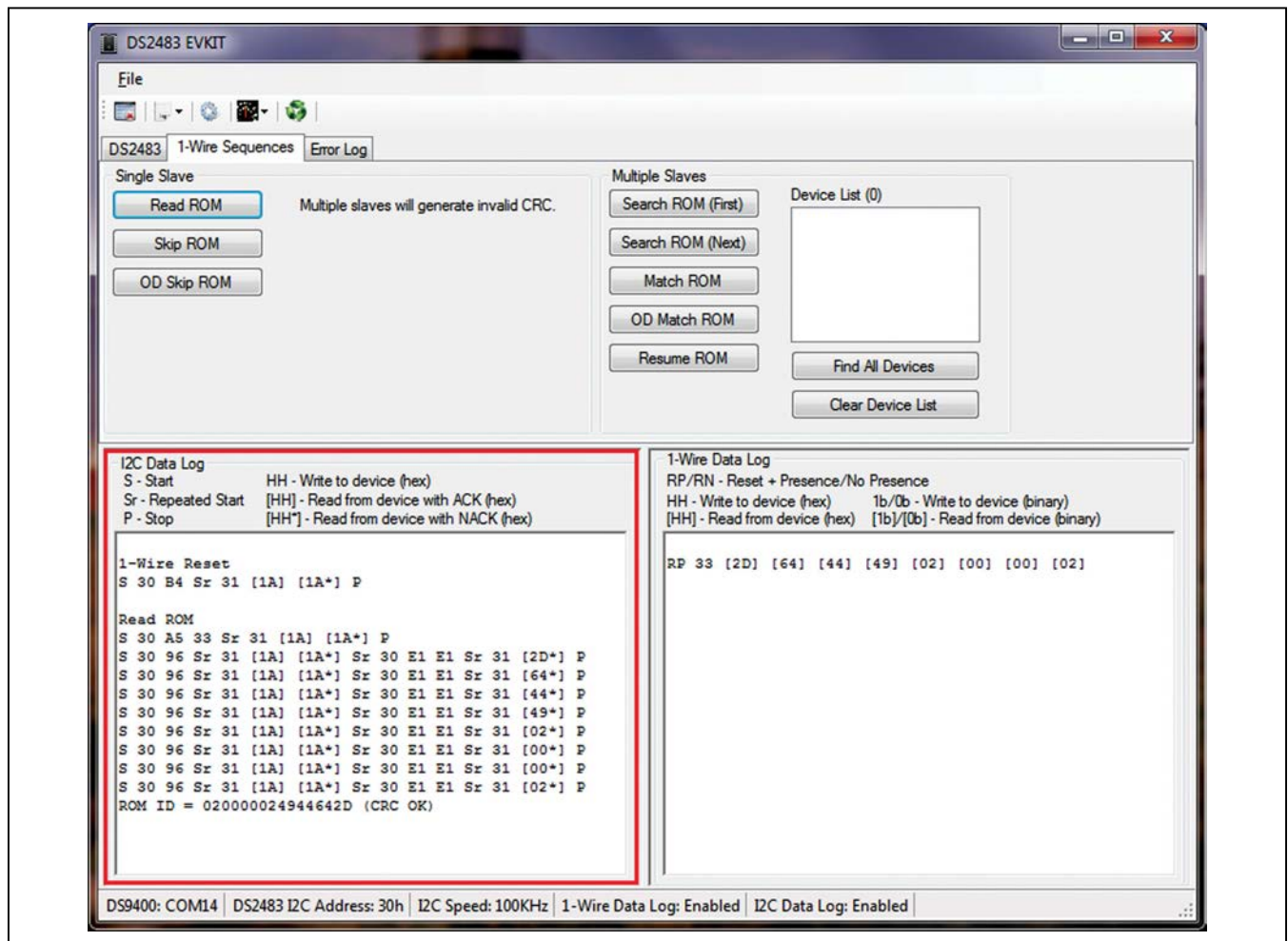

Figure 10. I<sup>2</sup>C Data Log Group Box



# DS2483 Evaluation System

## Evaluates: DS2483

The **Error Log** tab (Figure 12) allows the user to view any unhandled software exceptions. This error would display when the user does something that is outside the bounds of normal operation for the software and the software has

no way to handle the specific event. The exception as shown in Figure 12 was due to the user entering a value larger than what the Read Byte command could handle.

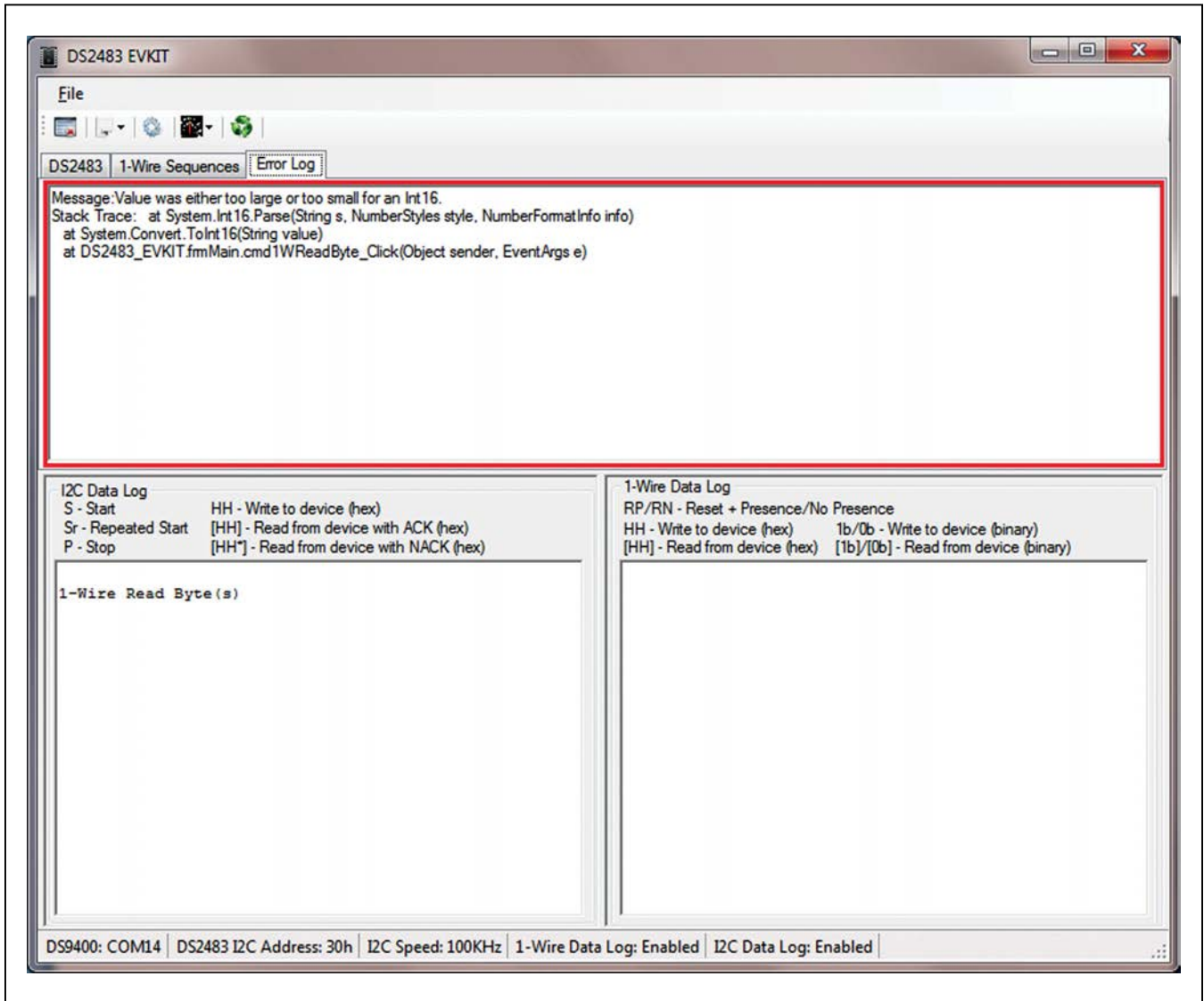

Figure 12. Error Log Tab

# DS2483 Evaluation System

## Evaluates: DS2483

### Mini Tool Bar

The mini tool bar icon short descriptions are provided in [Figure 13](#). The following is the long description of each icon:

- **Device Reset:** Causes the DS2483 to perform an internal reset cycle caused from executing the Device Reset command followed by a read of the Device Configuration register.
- **Change I2C Speed:** Allows the I2C bus to run at the selected frequency of 100kHz or 400kHz. The selection only affects the microcontroller. The DS2483 does not have to be configured for speed.
- **Change 1-Wire Timing:** Provides reading of the Port Configuration register and writing of the Adjust 1-Wire Port. The window is shown in [Figure 14](#). Adjustment to any timing parameter shown is done by selecting the timing **Parameter** and **Speed**, adjusting the slider symbol, and clicking on the **Write** button. Verification of the write can be done by clicking on the **Read** button. Exit by clicking on the **Close** button.

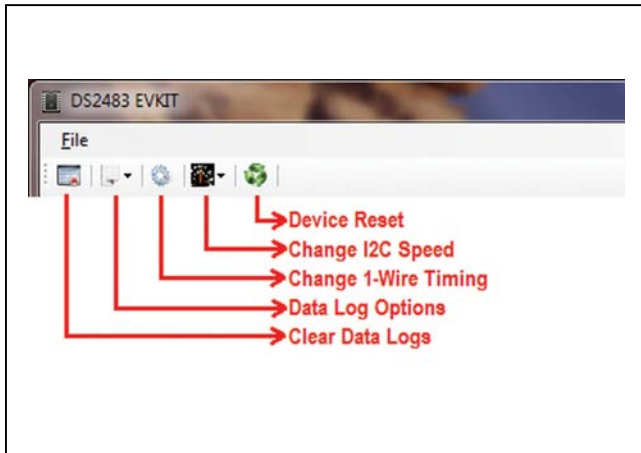

Figure 13. Mini Tool Bar

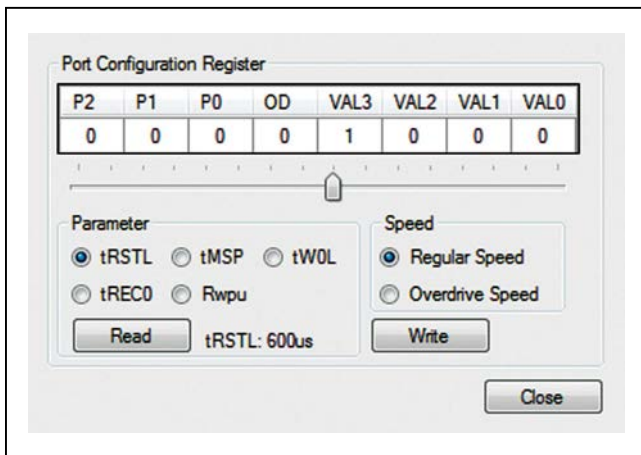

Figure 14. Port Configuration Register

- **Data Log Options:** Allows selecting to turn on/off the **1-Wire Data Log** or **I2C Data Log**.
- **Clear Data Logs:** Clears all data log group boxes.

### Viewer Menu

The viewer menu consists only of **File** with the only option in the drop-down menu to **Exit**. **Exit** closes the program. The program also ends by the keyboard keys (**Alt + f**) and then (**x**).

## Detailed Description of Connectors/Jumpers

### RJ11 Pinout

The RJ11 pinout mounted on the EV kit PCB at RJ1 is shown in [Table 3](#) and [Figure 15](#). RJ11 pin 1 can supply 3.3V or 1.8V and can be used for auxiliary board power. GND is ground of the 3.3V or 1.8V supply, depending on jumper settings. The signal 1-WIRE stands for the one-wire data bus. The ground return 1-WIRE is the signal GND\_RTN. Pins 5 and 6 marked as NC are not connected.

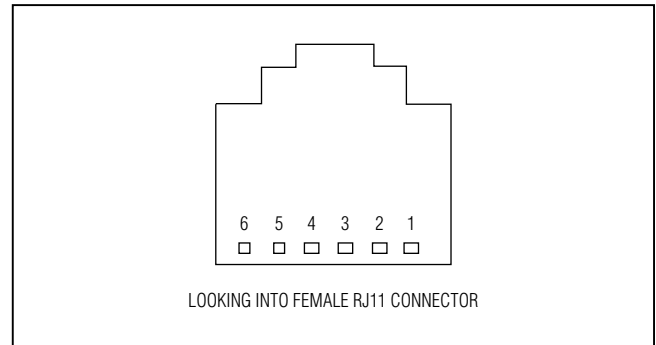

Figure 15. 1-Wire RJ11 Port

Table 3. 1-Wire RJ11 Pinout

CONNECTOR PIN #	SIGNAL NAME
1	VCC
2	GND
3	1-WIRE
4	GND_RTN
5	NC
6	NC

# DS2483 Evaluation System

## Evaluates: DS2483

### J2 Pinout

The 4-position 100-mil-spaced I<sup>2</sup>C I/F connector is mounted at J2 of the EV kit PCB, as shown in [Table 4](#). These signals are routed to U2 of the MAX3394E IC that is used as a dual-level translator to allow either 1.8V or 3.3V I<sup>2</sup>C signals to U3 of the DS2483 IC. J2 of the EV kit can be connected to J2 of the DS9400 for a complete EV system. The SDA\_PORT signal is the I<sup>2</sup>C serial-data input/output port and the SDC\_PORT is the I<sup>2</sup>C Serial-clock input port.

### Jumper Settings

The EV kit has three jumpers that are needed to select power-supply inputs for the DS2483 IC. [Figure 16](#) to [Figure 19](#) show the most common power-supply input selections for the DS2483 device.

**Table 4. I<sup>2</sup>C I/F Pinout**

CONNECTOR PIN #	SIGNAL NAME
1	VCC3.3
2	SDA_PORT
3	GND
4	SCL_PORT

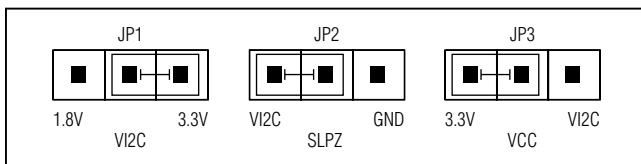

Figure 16. 3.3V Operation for Both the I<sup>2</sup>C and 1-Wire Interfaces

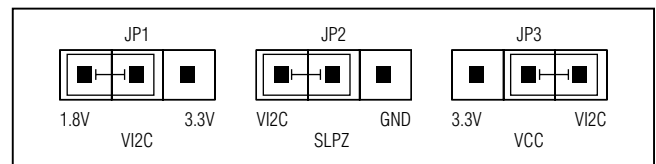

Figure 18. 1.8V I<sup>2</sup>C I/F and 1.8V 1-Wire

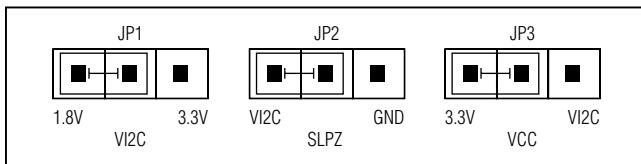

Figure 17. 1.8V I<sup>2</sup>C I/F and 3.3V 1-Wire

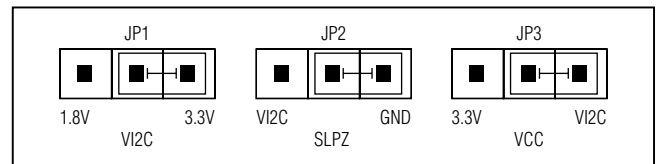

Figure 19. Powered Down (Sleep Mode)

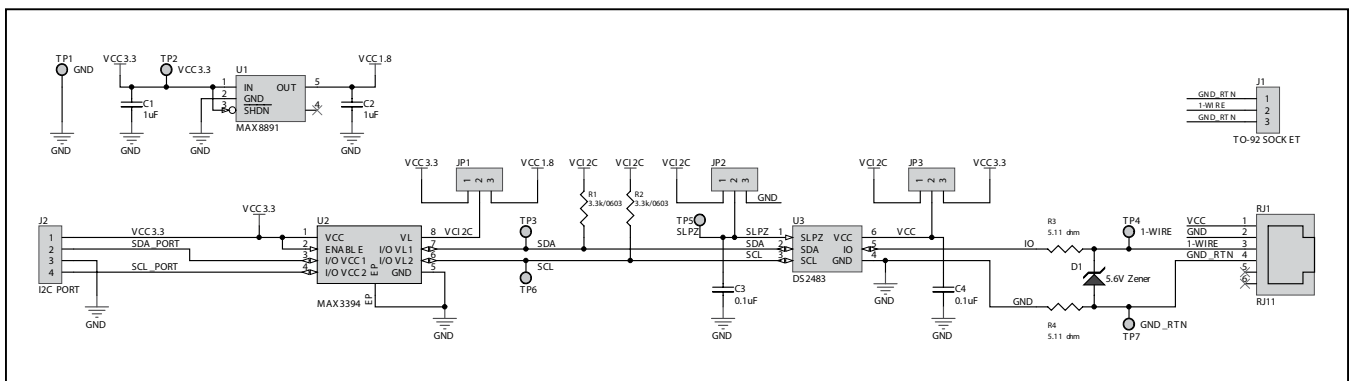

Figure 20. DS2483 EV Kit Schematic

# DS2483 Evaluation System

## Evaluates: DS2483

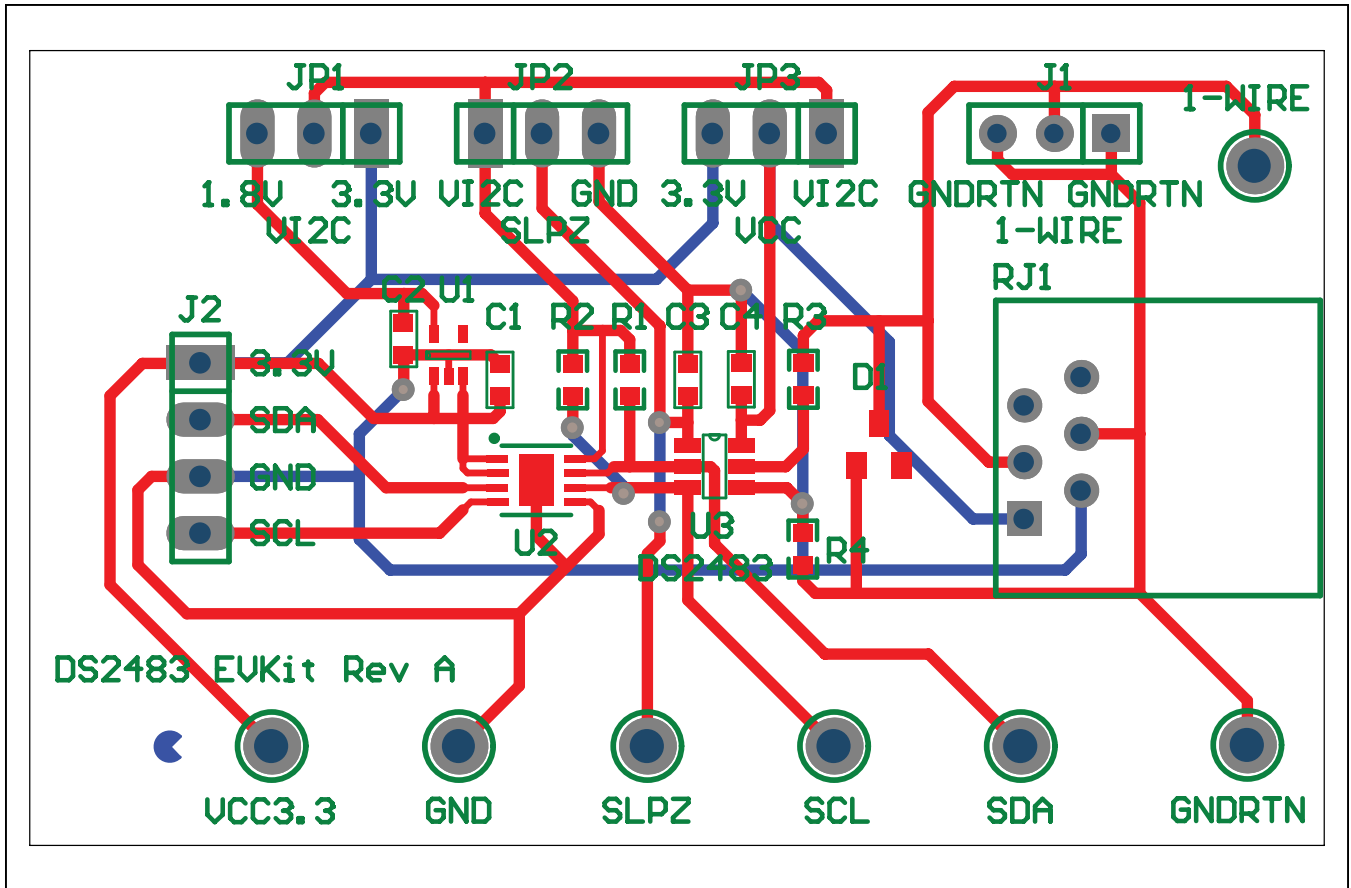

Figure 21. DS2483 EV Kit Composite Layout



# DS2483 Evaluation System

## Evaluates: DS2483

### ***Ordering Information***

---

<b>PART</b>	<b>TYPE</b>
DS2483K#	EV System

*#Denotes RoHS compliant.*

# DS2483 Evaluation System Evaluates: DS2483

## Revision History

REVISION NUMBER	REVISION DATE	DESCRIPTION	PAGES CHANGED
0	3/12	Initial release	—
1	8/12	Changed the orderable part number from DS2483EVKIT# to DS2483K# in the <i>General Description</i> and <i>Ordering Information</i> table	1, 17



Maxim Integrated cannot assume responsibility for use of any circuitry other than circuitry entirely embodied in a Maxim Integrated product. No circuit patent licenses are implied. Maxim Integrated reserves the right to change the circuitry and specifications without notice at any time. The parametric values (min and max limits) shown in the Electrical Characteristics table are guaranteed. Other parametric values quoted in this data sheet are provided for guidance.

**Maxim Integrated 160 Rio Robles, San Jose, CA 95134 USA 1-408-601-1000**

18