

3.2 x 1.6 x 0.5 (mm) GPS/WiFi/Bluetooth Combo PCB Substrate Antenna (EVB+AA089) Engineering Specification

1. Product Number

H 2 B 1 D G 1 A 1 G 0 2 0 0

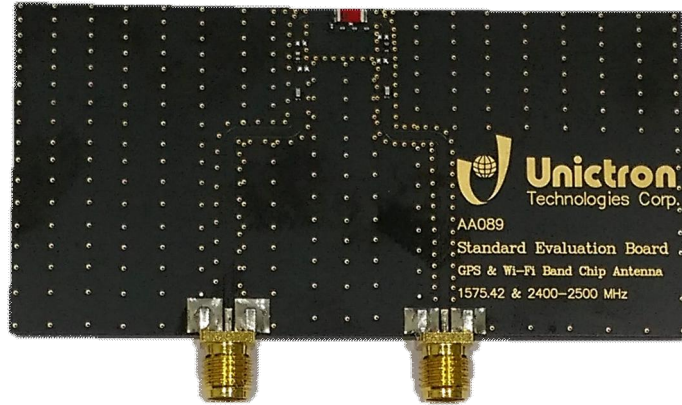

2. Features

- *Stable and reliable in performances
- *Good isolation between GPS bands and WiFi (Bluetooth) bands
- *Low profile, compact size
- *RoHS2.0 compliance
- *SMT processes compatible
- *Compatible with individual signal input or combined signal input

3. Applications

- *For GPS applications
- *For Wi-Fi/ Bluetooth/ BLE/ ZigBee/ 2.4GHz applications
- *For wireless devices when both GPS and Wi-Fi(Bluetooth) functions are needed, e.g., Smart phone, Tablet PC, Tracker, Real time video recorder. Smart watch...etc.

4. Description

Unictron's AA089 ceramic chip antenna is designed for GPS & Wi-Fi (B.T.) 2.4GHz band applications, covering frequencies 1575.42 MHz & 2400~2500MHz. Fabricated with proprietary design and processes, AA089 shows excellent performance and is fully compatible with SMT processes which can decrease the assembly cost and improve device's quality and consistency.



詠業科技股份有限公司
Unictron Technologies Corporation
Website:www.unictron.com

THIS DRAWINGS AND SPECIFICATIONS ARE THE PROPERTY OF UNICTRON TECHNOLOGIES CORPORATION AND SHALL NOT BE REPRODUCED OR USED AS THE BASIS FOR THE MANUFACTURE OR SALE OF APPARATUS OR DEVICES WITHOUT PERMISSION

2018-09-20

Document Control Center

Prepared by : Wen

Designed by : Allen

Checked by : Mike

Approved by : Herbert

TITLE : 3.2 x 1.6 x 0.5 (mm) GPS/WiFi/Bluetooth Combo PCB Substrate Antenna (EVB+AA089)Engineering Specification

DOCUMENT NO.

H2B1DG1A1G0200

REV.
A

5. Application for individual signal mode

5-1. Layout Guide (Unit : mm)

Solder Land Pattern:

The solder land pattern (gold marking areas) is shown below. Recommendation on matching circuit will be provided according to customer's installation conditions.

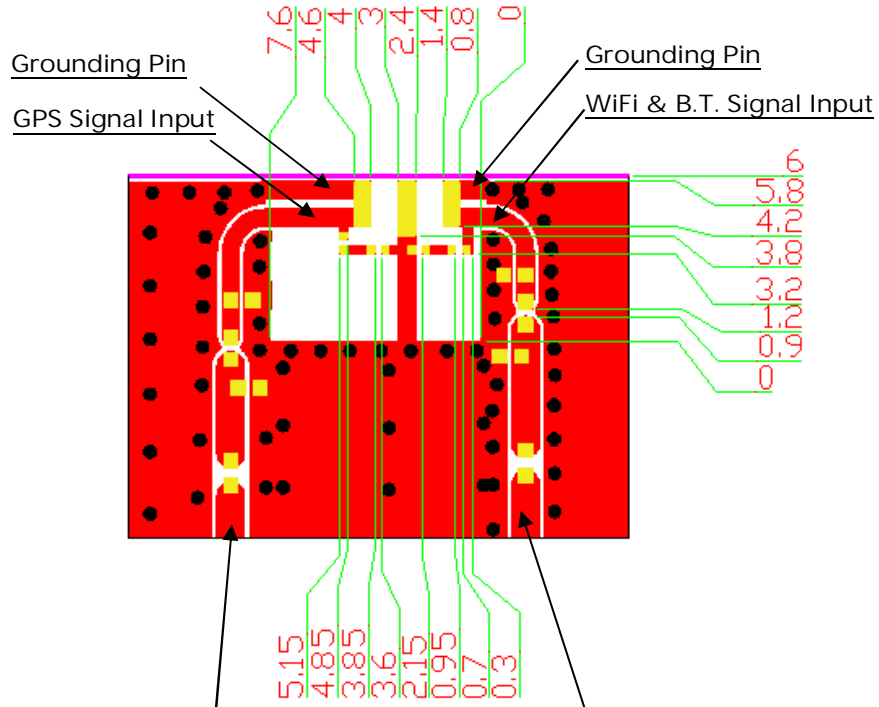

Transmission Line with 50Ω Impedance Characteristic

Top View

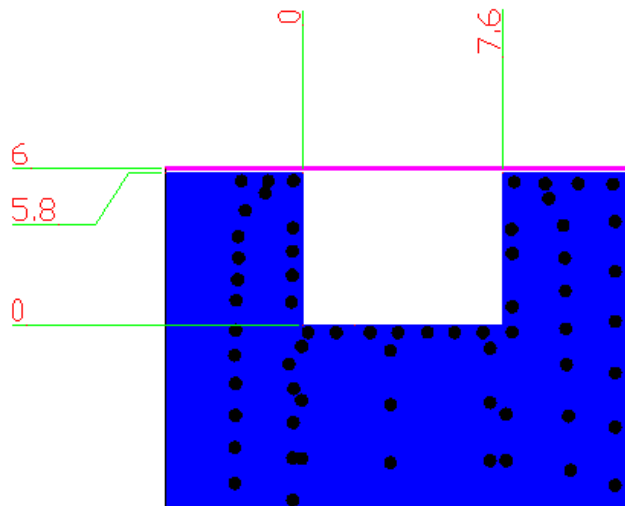

Bottom View



詠業科技股份有限公司
Unictron Technologies Corporation
Website: www.unictron.com

THIS DRAWINGS AND SPECIFICATIONS ARE THE PROPERTY OF UNICTRON TECHNOLOGIES CORPORATION AND SHALL NOT BE REPRODUCED OR USED AS THE BASIS FOR THE MANUFACTURE OR SALE OF APPARATUS OR DEVICES WITHOUT PERMISSION

Prepared by : Wen

Designed by : Allen

Checked by : Mike

Approved by : Herbert

TITLE : 3.2 x 1.6 x 0.5 (mm) GPS/WiFi/Bluetooth Combo
PCB Substrate Antenna
(EVB+AA089)Engineering Specification

DOCUMENT
NO.

H2B1DG1A1G0200

REV.
A

5-2. Electrical Specifications (Evaluation Board Dimensions: 80 x 40 mm²)

5-2-1. Electrical Table (GPS Band)

Characteristics		Specifications	Unit
Outline Dimensions		3.2 x 1.6 x 0.5	mm
Ground Plane Dimensions		80 x 40	mm
Working Frequency		1575.42	MHz
Isolation(S_{21})		≤ -20 (typical)	dB
VSWR (@ center frequency)*		2 Max.	
Characteristic Impedance		50	Ω
Polarization		Linear Polarization	
Peak Gain	(@ 1575.42 MHz)	1.3 (typical)**	dBi
Efficiency		61 (typical)**	%

*Center frequency means the frequency with the lowest value in return loss of the chip antenna on the evaluation board.

**A Typical value is for reference only, not guaranteed.

5-2-2. Electrical Table (WiFi & B.T. Band)

Characteristics		Specifications	Unit
Working Frequency		2400~2500	MHz
Isolation(S_{21})		≤ -16 (typical)	dB
VSWR (@ center frequency)*		2 Max.	
Characteristic Impedance		50	Ω
Polarization		Linear Polarization	
Peak Gain	(@ 2442 MHz)	1.8 (typical)**	dBi
Efficiency		68 (typical)**	%

*Center frequency means the frequency with the lowest value in return loss of the chip antenna on the evaluation board.

**A Typical value is for reference only, not guaranteed.



詠業科技股份有限公司
Unictron Technologies Corporation
Website: www.unictron.com

THIS DRAWINGS AND SPECIFICATIONS ARE THE PROPERTY OF UNICTRON TECHNOLOGIES CORPORATION AND SHALL NOT BE REPRODUCED OR USED AS THE BASIS FOR THE MANUFACTURE OR SALE OF APPARATUS OR DEVICES WITHOUT PERMISSION

Prepared by : **Wen**

Designed by : **Allen**

Checked by : **Mike**

Approved by : **Herbert**

TITLE : 3.2 x 1.6 x 0.5 (mm) GPS/WiFi/Bluetooth Combo
PCB Substrate Antenna
(EVB+AA089)Engineering Specification

DOCUMENT NO.

H2B1DG1A1G0200

REV.
A

5-2-3. Return Loss & VSWR of GPS Band

Return Loss (S₁₁)

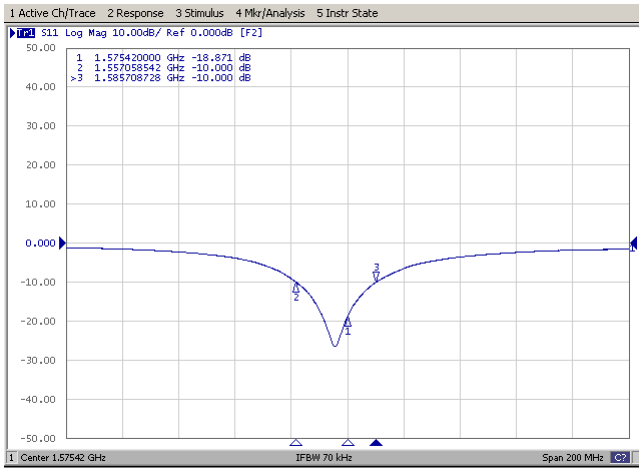

VSWR(S₁₁)

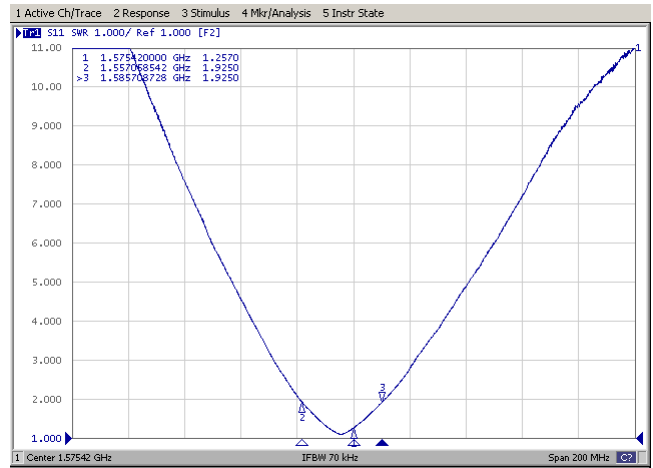

5-2-4. Return Loss & VSWR of WiFi (B.T.) Band

Return Loss (S₁₁)

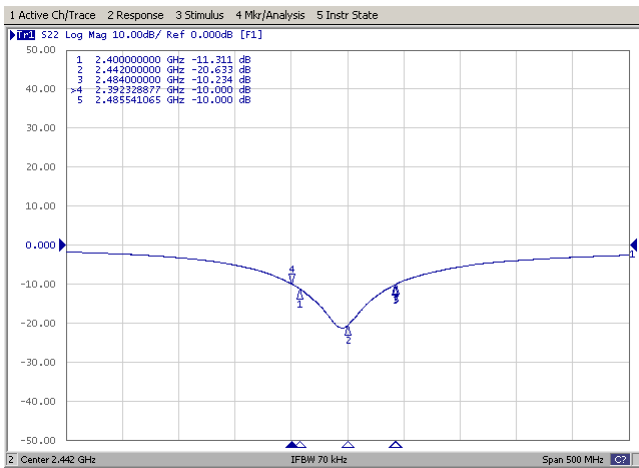

VSWR(S₁₁)

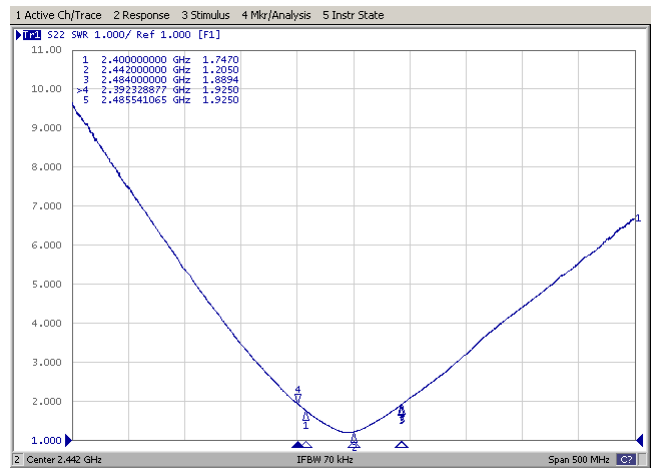

5-2-5. Isolation between GPS Band & WiFi (B.T.) Band

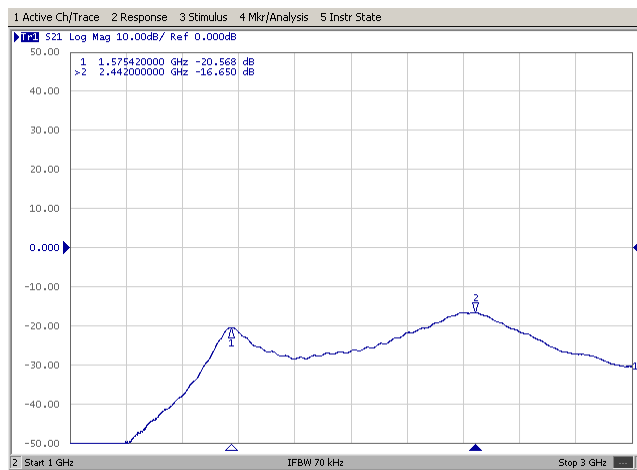

Unictron Technologies Corp.
2018-09-20
Document Control Center



詠業科技股份有限公司
Unictron Technologies Corporation
Website: www.unictron.com

THIS DRAWINGS AND SPECIFICATIONS ARE THE PROPERTY OF UNICTRON TECHNOLOGIES CORPORATION AND SHALL NOT BE REPRODUCED OR USED AS THE BASIS FOR THE MANUFACTURE OR SALE OF APPARATUS OR DEVICES WITHOUT PERMISSION

Prepared by : Wen

Designed by : Allen

Checked by : Mike

Approved by : Herbert

TITLE : 3.2 x 1.6 x 0.5 (mm) GPS/WiFi/Bluetooth Combo PCB Substrate Antenna (EVb+AA089) Engineering Specification

DOCUMENT NO.

H2B1DG1A1G0200

REV. A

5-3. Evaluation Board with Antenna

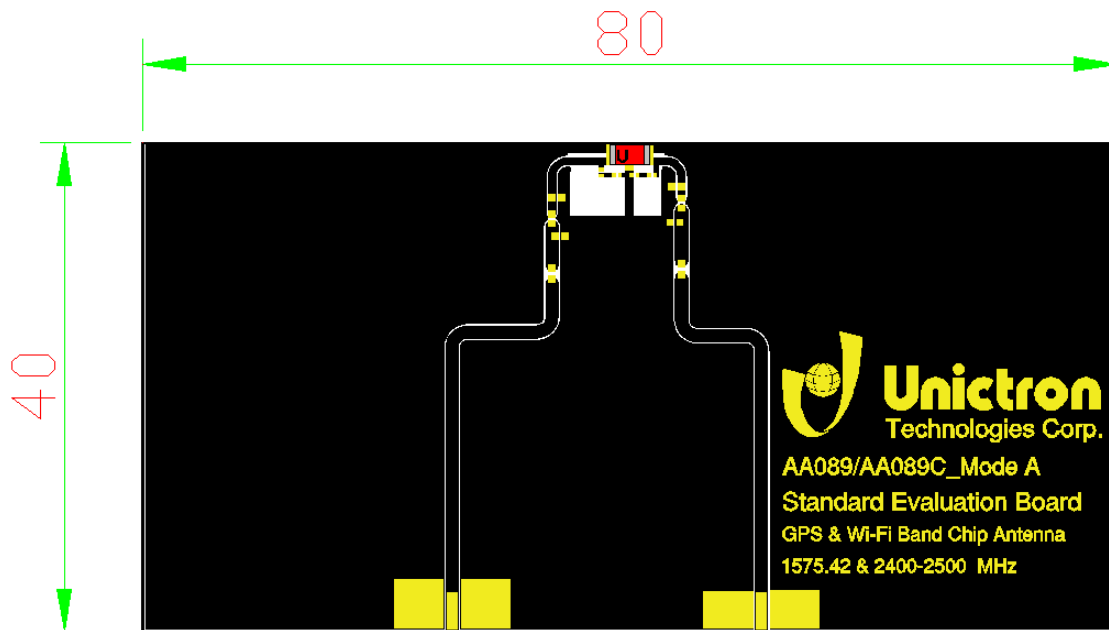

Unit : mm



詠業科技股份有限公司
Unictron Technologies Corporation
Website: www.unictron.com

THIS DRAWINGS AND SPECIFICATIONS ARE THE PROPERTY OF UNICTRON TECHNOLOGIES CORPORATION AND SHALL NOT BE REPRODUCED OR USED AS THE BASIS FOR THE MANUFACTURE OR SALE OF APPARATUS OR DEVICES WITHOUT PERMISSION

Prepared by : **Wen** Designed by : **Allen** Checked by : **Mike** Approved by : **Herbert**

TITLE : 3.2 x 1.6 x 0.5 (mm) GPS/WiFi/Bluetooth Combo PCB Substrate Antenna (EVB+AA089)Engineering Specification	DOCUMENT NO.	H2B1DG1A1G0200	REV.
			A

5-4. Radiation Pattern (with 80 x 40 mm² Evaluation Board)

5-4-1 GPS Band

5-4-1-1. 3D Gain Pattern @ 1575.42 MHz (unit: dBi)

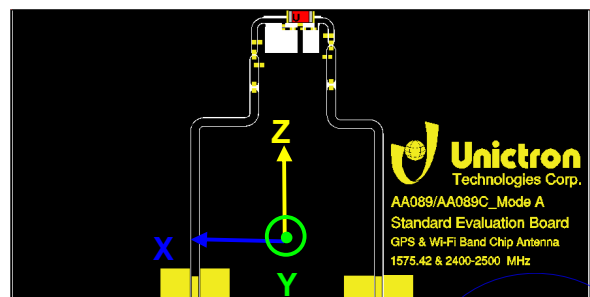
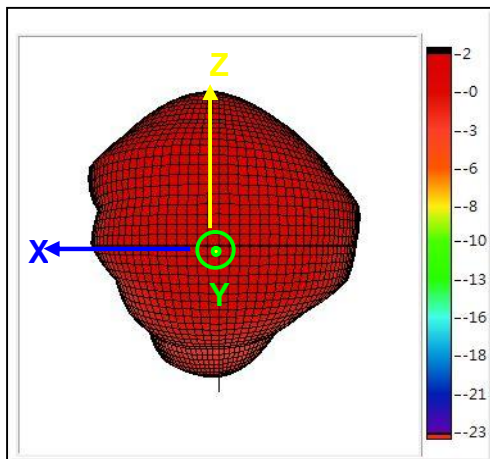
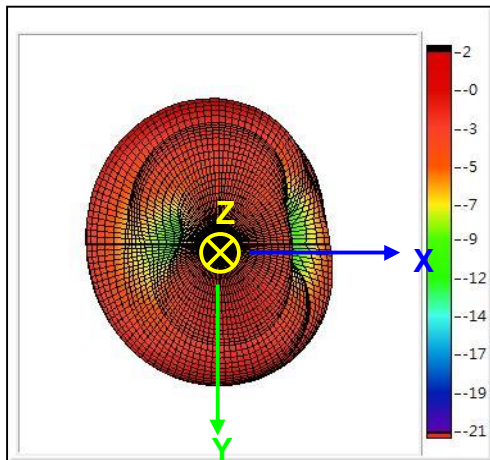
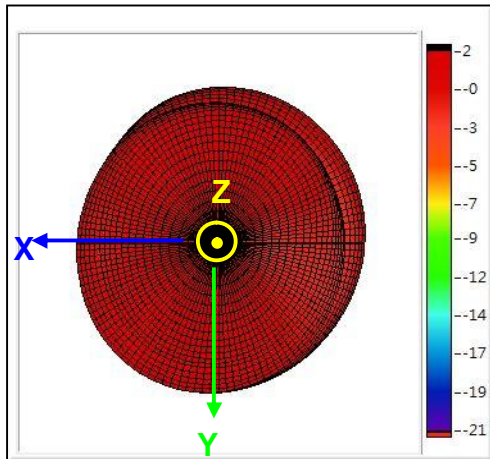

Unictron
Technologies Corp.
2018-09-20

Document
Control Center



詠業科技股份有限公司
Unictron Technologies Corporation
Website: www.unictron.com

THIS DRAWINGS AND SPECIFICATIONS ARE THE PROPERTY OF UNICTRON TECHNOLOGIES CORPORATION AND SHALL NOT BE REPRODUCED OR USED AS THE BASIS FOR THE MANUFACTURE OR SALE OF APPARATUS OR DEVICES WITHOUT PERMISSION

Prepared by : Wen

Designed by : Allen

Checked by : Mike

Approved by : Herbert

TITLE : 3.2 x 1.6 x 0.5 (mm) GPS/WiFi/Bluetooth Combo
PCB Substrate Antenna
(EVB+AA089)Engineering Specification

DOCUMENT
NO.

H2B1DG1A1G0200

REV.

A

5-4-1-2. 3D Efficiency Table

Frequency(MHz)	1570	1571	1572	1573	1574	1575	1576	1577	1578	1579	1580
Efficiency(dB)	-2.1	-2.1	-2.1	-2.1	-2.1	-2.1	-2.1	-2.1	-2.2	-2.2	-2.2
Efficiency(%)	61.0	61.4	61.7	61.6	61.4	61.4	61.3	61.0	60.7	60.6	60.0
Peak Gain(dBi)	1.4	1.4	1.4	1.4	1.3	1.3	1.3	1.2	1.2	1.1	1.1

5-4-1-3. 3D Efficiency vs. Frequency

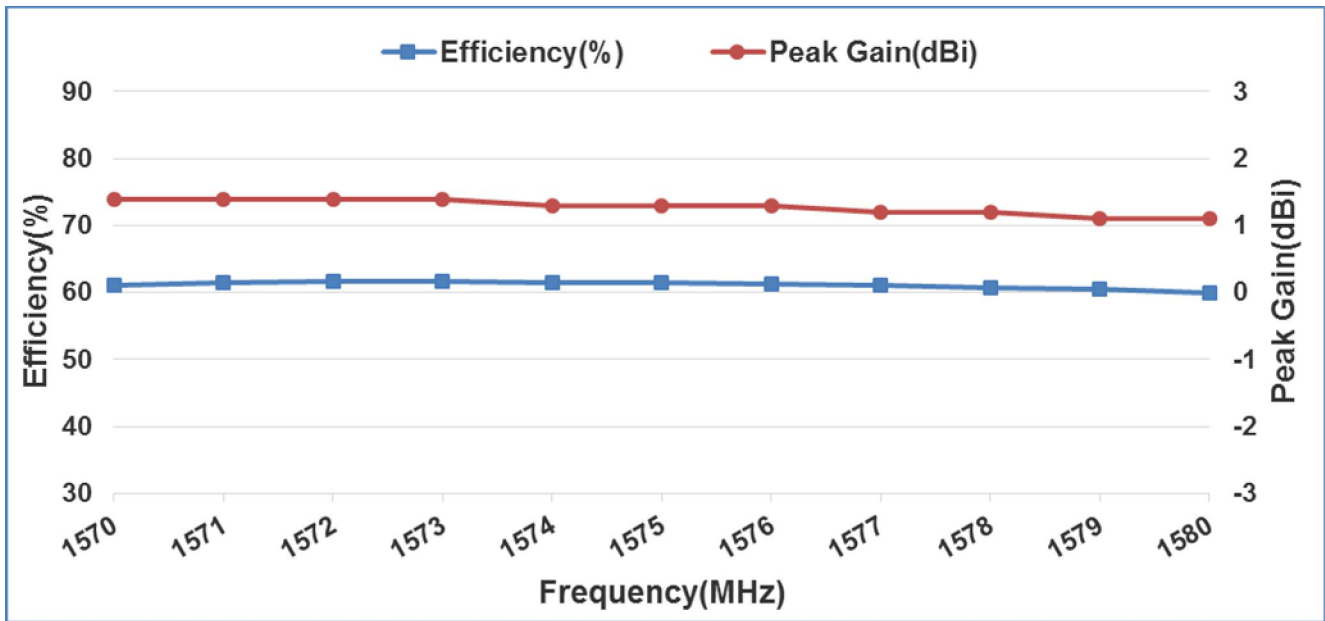

詠業科技股份有限公司
Unictron Technologies Corporation
Website: www.unictron.com

THIS DRAWINGS AND SPECIFICATIONS ARE THE PROPERTY OF UNICTRON TECHNOLOGIES CORPORATION AND SHALL NOT BE REPRODUCED OR USED AS THE BASIS FOR THE MANUFACTURE OR SALE OF APPARATUS OR DEVICES WITHOUT PERMISSION

Prepared by : **Wen** Designed by : **Allen** Checked by : **Mike** Approved by : **Herbert**

TITLE : 3.2 x 1.6 x 0.5 (mm) GPS/WiFi/Bluetooth Combo PCB Substrate Antenna (EVB+AA089)Engineering Specification	DOCUMENT NO.	H2B1DG1A1G0200	REV.
			A

5-4-2. WiFi & B.T. Band

5-4-2-1. 3D Gain Pattern @ 2442 MHz (unit: dBi)

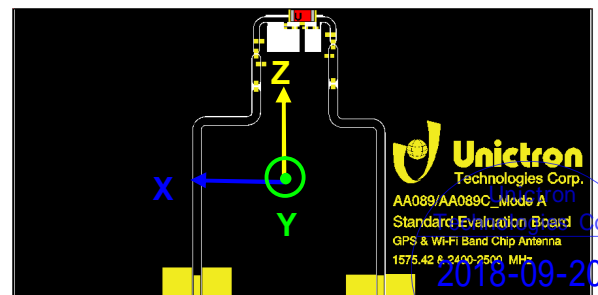
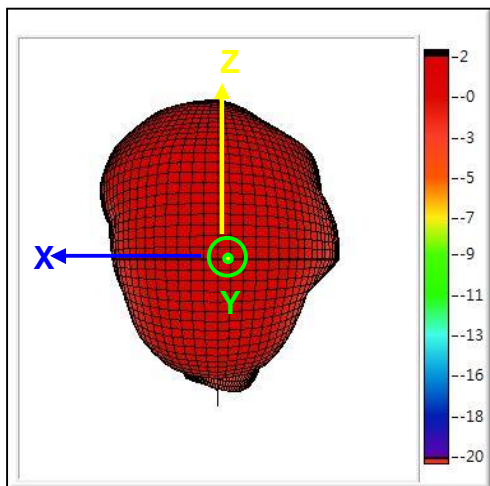
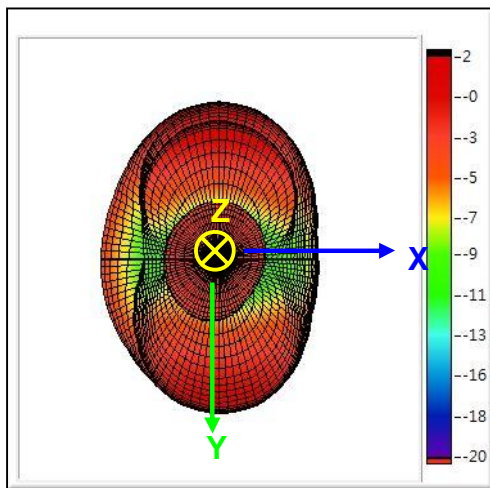
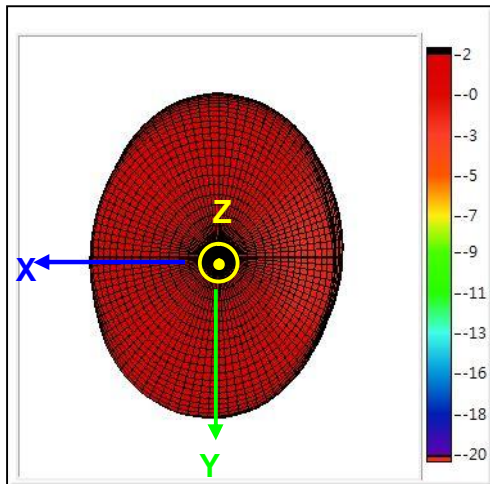

詠業科技股份有限公司
Unictron Technologies Corporation
Website: www.unictron.com

THIS DRAWINGS AND SPECIFICATIONS ARE THE PROPERTY OF UNICTRON TECHNOLOGIES CORPORATION AND SHALL NOT BE REPRODUCED OR USED AS THE BASIS FOR THE MANUFACTURE OR SALE OF APPARATUS OR DEVICES WITHOUT PERMISSION

Prepared by : Wen

Designed by : Allen

Checked by : Mike

Approved by : Herbert

TITLE : 3.2 x 1.6 x 0.5 (mm) GPS/WiFi/Bluetooth Combo PCB Substrate Antenna (EVb+AA089)Engineering Specification

DOCUMENT NO.

H2B1DG1A1G0200

REV. A

5-4-2-2. 3D Efficiency Table

Frequency(MHz)	2400	2412	2417	2422	2427	2432	2437	2442	2447	2452	2457	2462	2467	2472	2484	2500
Efficiency(dB)	-2.2	-2.1	-2.0	-1.9	-1.8	-1.7	-1.7	-1.6	-1.7	-1.6	-1.6	-1.6	-1.6	-1.8	-2.2	-2.5
Efficiency(%)	59.6	61.1	63.8	64.7	66.1	67.7	68.1	68.7	68.1	68.9	69.0	69.2	68.5	66.4	59.7	56.6
Peak Gain(dBi)	1.7	1.6	1.7	1.7	1.7	1.7	1.8	1.8	1.7	1.7	1.8	1.8	1.8	1.8	1.6	1.5

5-4-2-3. 3D Efficiency vs. Frequency

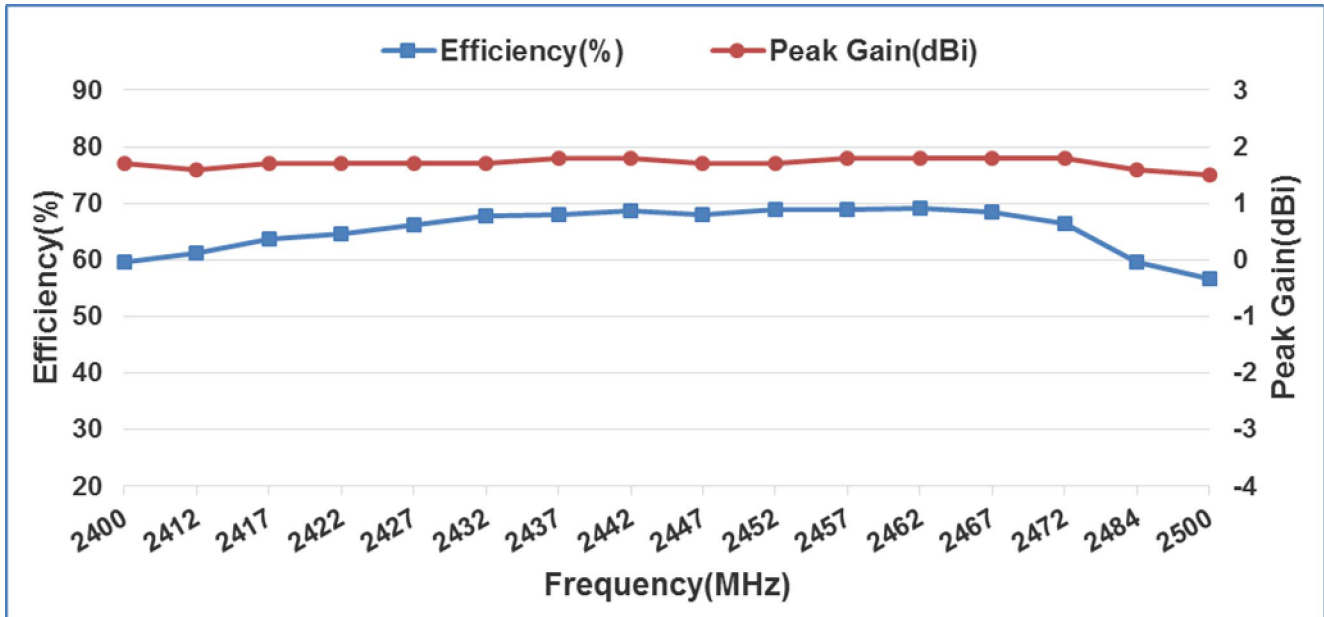

Unictron
Technologies Corp.
2018-09-20
Document
Control Center



詠業科技股份有限公司
Unictron Technologies Corporation
Website: www.unictron.com

THIS DRAWINGS AND SPECIFICATIONS ARE THE PROPERTY OF UNICTRON TECHNOLOGIES CORPORATION AND SHALL NOT BE REPRODUCED OR USED AS THE BASIS FOR THE MANUFACTURE OR SALE OF APPARATUS OR DEVICES WITHOUT PERMISSION

Prepared by : **Wen** Designed by : **Allen** Checked by : **Mike** Approved by : **Herbert**

TITLE : 3.2 x 1.6 x 0.5 (mm) GPS/WiFi/Bluetooth Combo PCB Substrate Antenna (EVB+AA089)Engineering Specification	DOCUMENT NO.	H2B1DG1A1G0200	REV.
			A

5-5. Frequency tuning and Matching circuit

5-5-1. Chip antenna tuning scenario :

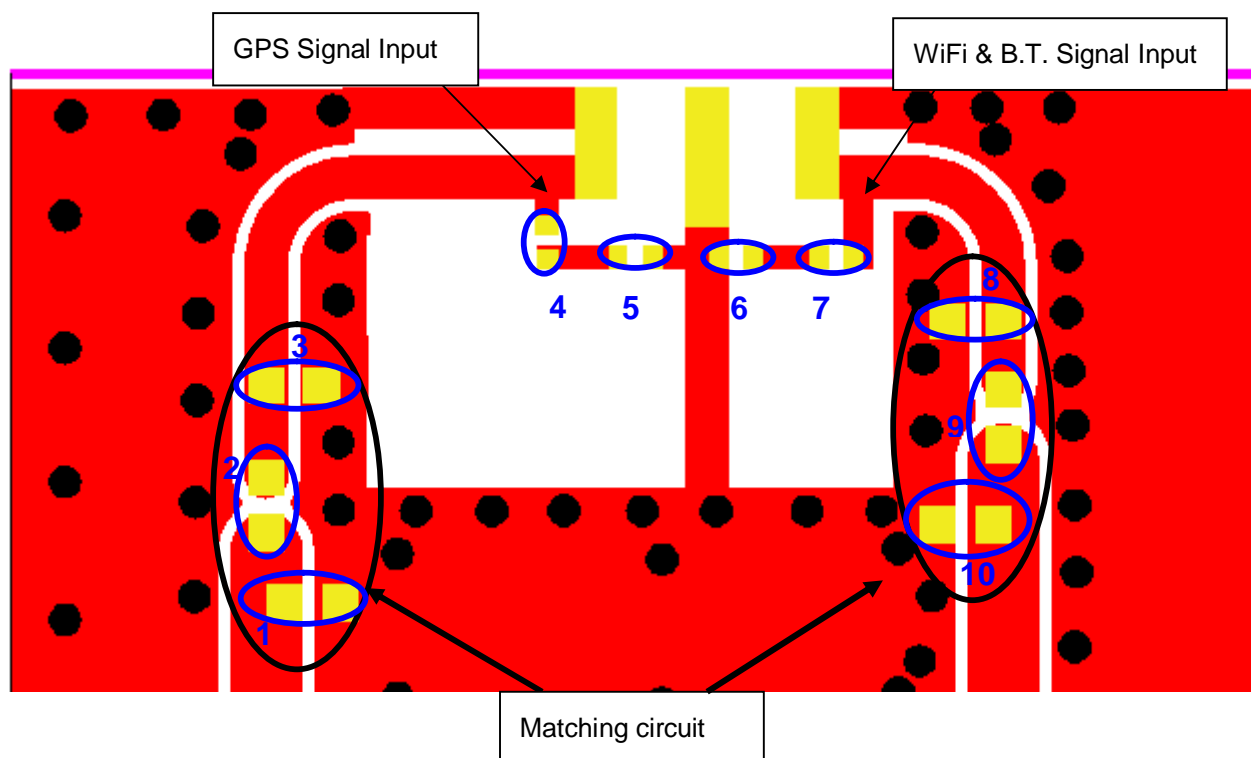

詠業科技股份有限公司
Unictron Technologies Corporation
Website: www.unictron.com

THIS DRAWINGS AND SPECIFICATIONS ARE THE PROPERTY OF UNICTRON TECHNOLOGIES CORPORATION AND SHALL NOT BE REPRODUCED OR USED AS THE BASIS FOR THE MANUFACTURE OR SALE OF APPARATUS OR DEVICES WITHOUT PERMISSION

Prepared by : Wen

Designed by : Allen

Checked by : Mike

Approved by : Herbert

TITLE : 3.2 x 1.6 x 0.5 (mm) GPS/WiFi/Bluetooth Combo PCB Substrate Antenna (EVB+AA089) Engineering Specification

DOCUMENT NO.

H2B1DG1A1G0200

REV.
A

5-5-2. Matching circuit :

With the following recommended values of matching and tuning components, the center frequencies will be about 1575.42 MHz on GPS band and 2442 MHz on WiFi (B.T.) band at our standard 80 x 40 mm² evaluation board. However, these are typical reference values which may need to be changed when circuit boards or part vendors are different.

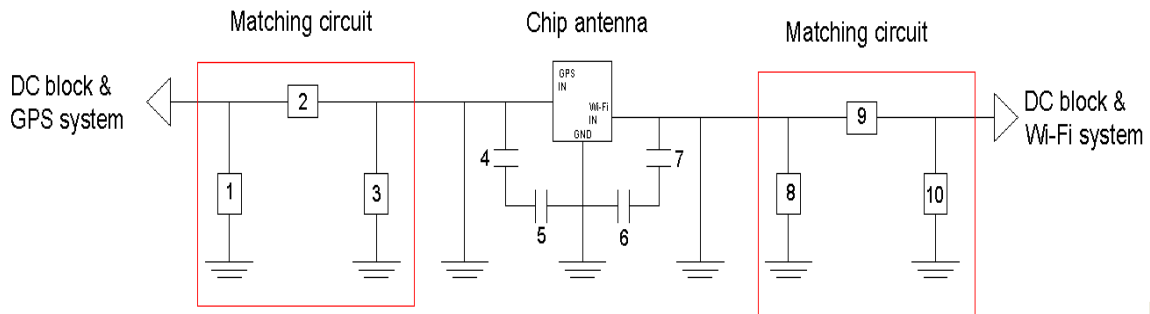

System Matching Circuit Component			
Location	Description	Vendor	Tolerance
1	N/A	-	-
2	4.7nH, (0402)	MURATA	±0.3nH
3	N/A	-	-
4 Fine tuning element	2.7pF, (0201)	MURATA	±0.05pF
5 Fine tuning element	1pF, (0201)	MURATA	±0.05pF
6 Fine tuning element	0.6pF, (0201)	MURATA	±0.05pF
7 Fine tuning element	0.8pF, (0201)	MURATA	±0.05pF
8	N/A		
9	0Ω, (0402)	-	-
10	N/A		
DC Block	22pF, (0402)	MURATA	±5%



詠業科技股份有限公司
Unictron Technologies Corporation
Website: www.unictron.com

THIS DRAWINGS AND SPECIFICATIONS ARE THE PROPERTY OF UNICTRON TECHNOLOGIES CORPORATION AND SHALL NOT BE REPRODUCED OR USED AS THE BASIS FOR THE MANUFACTURE OR SALE OF APPARATUS OR DEVICES WITHOUT PERMISSION

Prepared by : **Wen**

Designed by : **Allen**

Checked by : **Mike**

Approved by : **Herbert**

TITLE : 3.2 x 1.6 x 0.5 (mm) GPS/WiFi/Bluetooth Combo
PCB Substrate Antenna
(EVb+AA089)Engineering Specification

DOCUMENT NO.

H2B1DG1A1G0200

REV.
A

6. Outline Dimensions of Antenna & Evaluation Board (unit: mm)

6-1. Antenna Dimensions

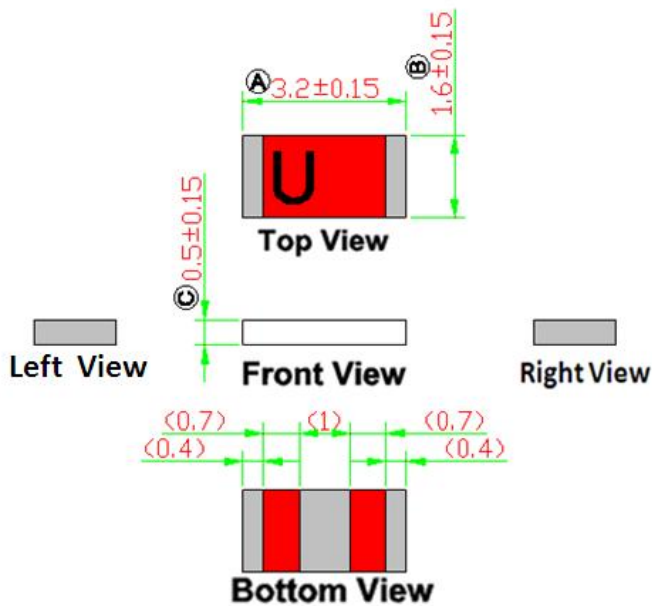

NOTE:

1. All materials are RoHS 2.0 compliant.
2. "A"~"C" Critical Dimensions.
3. "()" Reference Dimensions.

PIN Definitions

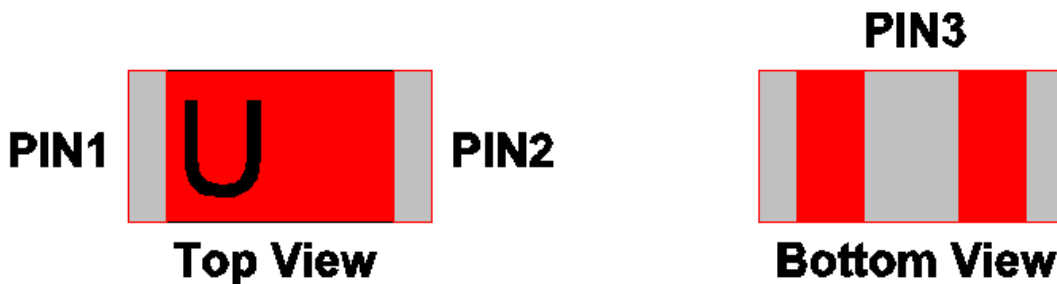

PIN	1	2	3
Soldering PAD (Individual signal)	GPS Signal	Wi-Fi & B.T. Signal	Tuning / Ground
Soldering PAD (Combined signal)	Tuning / Ground	Tuning / Ground	GPS & Wi-Fi(B.T.) Signal

Unictron Technologies Corp.

2018-09-20

Document Control Center



詠業科技股份有限公司
Unictron Technologies Corporation
Website: www.unictron.com

THIS DRAWINGS AND SPECIFICATIONS ARE THE PROPERTY OF UNICTRON TECHNOLOGIES CORPORATION AND SHALL NOT BE REPRODUCED OR USED AS THE BASIS FOR THE MANUFACTURE OR SALE OF APPARATUS OR DEVICES WITHOUT PERMISSION

Prepared by : Wen

Designed by : Allen

Checked by : Mike

Approved by : Herbert

TITLE : 3.2 x 1.6 x 0.5 (mm) GPS/WiFi/Bluetooth Combo PCB Substrate Antenna (EVB+AA089) Engineering Specification

DOCUMENT NO.

H2B1DG1A1G0200

REV.

A

7. Soldering Conditions

8-1. Typical Soldering Profile for Lead-free Process

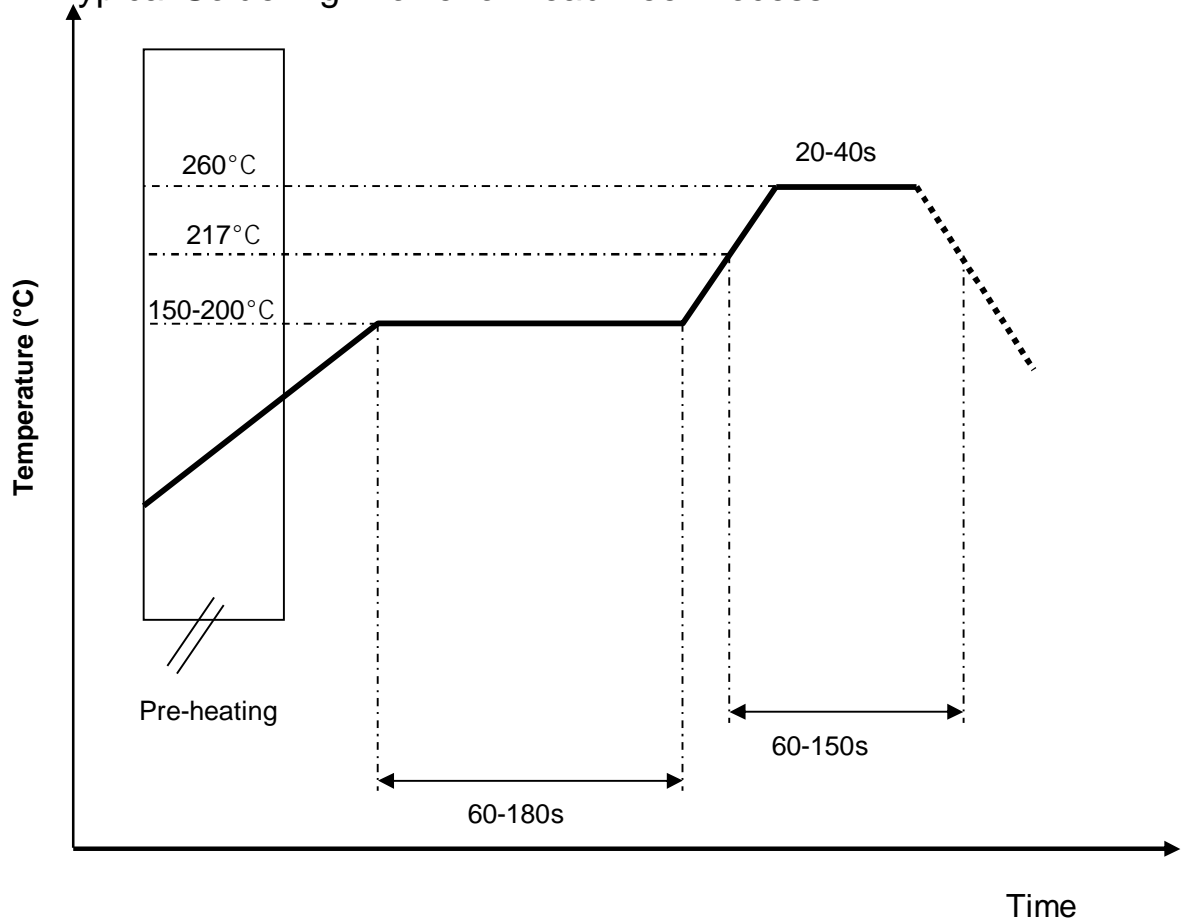

*Recommended solder paste alloy: SAC305 (Sn96.5 /Ag3 /Cu0.5) Lead Free solder paste



詠業科技股份有限公司
Unictron Technologies Corporation
Website: www.unictron.com

THIS DRAWINGS AND SPECIFICATIONS ARE THE PROPERTY OF UNICTRON TECHNOLOGIES CORPORATION AND SHALL NOT BE REPRODUCED OR USED AS THE BASIS FOR THE MANUFACTURE OR SALE OF APPARATUS OR DEVICES WITHOUT PERMISSION

Prepared by : Wen

Designed by : Allen

Checked by : Mike

Approved by : Herbert

TITLE : 3.2 x 1.6 x 0.5 (mm) GPS/WiFi/Bluetooth Combo PCB Substrate Antenna (EVB+AA089) Engineering Specification

DOCUMENT NO.

H2B1DG1A1G0200

REV.

A

8. Reminders for users of Unictron's AA089 ceramic chip antennas

- 8-1. This chip antenna is made of ceramic materials which are relatively more rigid and brittle compared to circuit board materials. Furthermore, the length of this antenna is quite long. Bending of circuit board at the locations where chip antenna is mounted may cause the cracking of solder joints or antenna itself.
- 8-2. Punching/cutting of the break-off tab of PCB panel may cause severe bending of the circuit board which may result in cracking of solder joints or chip antenna itself. Therefore break-off tab shall be located away from the installation site of chip antenna.
- 8-3. Be cautious when ultrasonic welding process needs to be used near the locations where chip antennas are installed. Strong ultrasonic vibration may cause the cracking of chip antenna solder joints.

9. Operating & Storage Conditions

9-1. Operating

- (1) Maximum Input Power: 2 W
- (2) Operating Temperature: -40°C to 85°C

9-2. Storage

- (1) Storage Temperature: -5°C to 40°C
- (2) Relative Humidity: 20% to 70%
- (3) Shelf Life: 1 year

10. Notice

- (1) Installation Guide:
Please refer to Unictron's application note "General guidelines for the installation of Unictron's chip antennas" for further information.
- (2) All specifications are subject to change without notice.



 **詠業科技股份有限公司**
Unictron Technologies Corporation
Website: www.unictron.com

THIS DRAWINGS AND SPECIFICATIONS ARE THE PROPERTY OF UNICTRON TECHNOLOGIES CORPORATION AND SHALL NOT BE REPRODUCED OR USED AS THE BASIS FOR THE MANUFACTURE OR SALE OF APPARATUS OR DEVICES WITHOUT PERMISSION

Prepared by : **Wen** Designed by : **Allen** Checked by : **Mike** Approved by : **Herbert**

TITLE : 3.2 x 1.6 x 0.5 (mm) GPS/WiFi/Bluetooth Combo PCB Substrate Antenna (EVB+AA089)Engineering Specification	DOCUMENT NO.	H2B1DG1A1G0200	REV.
			A