

Datasheet

The Sure Cross® Vibration and Temperature Sensor works in a variety of machines to identify and predict failures in rotating machinery.



- Detects dual-axis vibration
- Provides high accuracy vibration and temperature measurements
- Manufactured with a robust zinc alloy housing
- Connects via a 1-wire serial interface
- Designed to work with *FlexPower* 1-Wire Serial Interface Node models DX80N9X1S-P6 and DX80N2X1S-P6, the 10 to 30 V dc powered 1-Wire Serial Interface Node models DX80N9X6S-P6 and DX80N2X6S-P6, MultiHop M-H6 and M-H6L radios, and Wireless Q45 Sensor Nodes DX80N2Q45VT and DX80N9Q45VT

For additional information, updated documentation, and a list of accessories, refer to Banner Engineering's website, www.bannerengineering.com/wireless.



WARNING: Not To Be Used for Personnel Protection

Never use this device as a sensing device for personnel protection. Doing so could lead to serious injury or death. This device does not include the self-checking redundant circuitry necessary to allow its use in personnel safety applications. A sensor failure or malfunction can cause either an energized or de-energized sensor output condition.

Models

Model	Power Requirements	Connection and Cable	I/O
QM42VT1	3.6 V dc to 5.5 V dc	3 m cable with a 5-pin M12/Euro-style male quick disconnect (QD)	Vibration and temperature using a 1-wire serial interface
QM42VT1QP		150 mm (6 in) PVC cable with a 5-pin M12/Euro-style male quick disconnect (QD)	

Configure this sensor using the [Sensor Configuration Tool](#) and adapter cable BWA-USB1WIRE-001 (datasheet [170020](#)).

ISO 10816 provides guidance for evaluating vibration velocity severity motors, pumps, fans, compressors, gear boxes, blowers, dryers, presses, and other machines that operate in the 10 to 1000 Hz frequency range.

Machine		Class I Small Machines	Class II Medium Machines	Class III Large Rigid Foundation	Class IV Large Soft Foundation	
Vibration Velocity Vrms	in/s	mm/s				
	0.01	0.28				
	0.02	0.45				
	0.03	0.71		good		
	0.04	1.12				
	0.07	1.80				
	0.11	2.80		satisfactory		
	0.18	4.50				
	0.28	7.10		unsatisfactory		
	0.44	11.2				
	0.70	18.0				
	1.10	28.0		unacceptable		
1.77	45.9					

Figure 1. Vibration Severity per ISO 10816



Installation Instructions

Connecting the Vibration/Temperature Sensor

To install the sensor to a device with a 5-pin M12/Euro-style female connector:

1. Align the notch in the female connector with the key in the sensor's male connector.
2. Gently slide the sensor end into the connector.
3. Rotate the threaded nut to tighten the sensor down.

Wiring

This sensor is designed to be plugged directly into compatible Nodes. The Node powers the sensor and periodically requests data using the 1-wire serial interface. Refer to the Class I Division 2 control drawings (p/n [143086](#)) for wiring specifications or limitations.

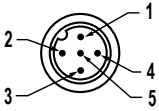
5-pin M12/Euro-style Connector (Male)	Pin	Wire Color	Sensor Connection
	1	Brown	Power IN (+), 3.6 to 5.5 V dc
	2	White	1-Wire serial device select (sinking input to sensing device)
	3	Blue	Ground (-)
	4	Black	Not used/reserved
	5	Gray	1-Wire serial communications

Installing the VT1 or VT2 Sensor

The vibration sensors have an X and Z axis indication on the face of the sensor. The Z axis goes in a plane through the sensor while the X is parallel to the sensor.

- Install the X axis in line with the shaft of the motor or axially.
- Install the Z axis to go into or through the motor or radial.

For the best results, install the sensor as close to the motor bearing as possible. If this is not possible, install the sensor on a surface that is in rigid connection with vibration characteristics of the motor. Using a cover shroud or other flexible mounting location may result in reduced accuracy or reduced ability to detect certain vibration characteristics.

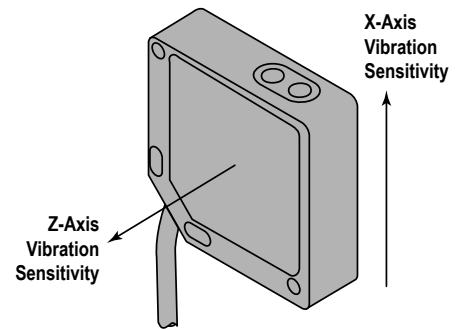

After determining the sensor direction and location, mount the sensor for the best possible vibration sensing accuracy. Mounting options in order from least effective to most effective are as follows:

Mounting Options	Effectiveness	Description
BWA-HW-057 Thermally Conductive Adhesive tape	Least effective	Often provides a more than sufficient mounting type but does introduce some additional flex that reduces accuracy
BWA-BK-001 Flat magnet sensor bracket		Gives a solid, strong, and adjustable mount to a motor, but with a motor's curved surface it may not provide the best connection if the motor is too small for the magnet to get a full connection with the motor housing. Magnet mounts are susceptible to accidentally rotation or change in sensor location if an outside force bumps or moves the sensor. This can lead to a change in sensor information that differs from the time-trended data from the previous location.
BWA-BK-008 Curved surface magnet attached to sensor bracket via ¼-28 bolt		Curved surface magnet mounts may provide a stronger mount to smaller curved motor surfaces than a flat magnet mount and need to be oriented in the correct direction for the strongest mount. If the magnet feels loose, rotate the magnet 45° or 90° and check again for the strongest connection. Magnet mounts are susceptible to accidentally rotation or change in sensor location if an outside force bumps or moves the sensor. This can lead to a change in sensor information that differs from the time-trended data from the previous location.

Mounting Options	Effectiveness	Description
BWA-BK-002 or BWA-BK-005 Flat bracket epoxied to motor and sensor screwed to bracket Recommend using an epoxy designed for accelerometer mounting, such as Loctite Depend 330 and 7388 activator.		Epoxying a bracket to a motor provides a permanent installation of the bracket to which the sensor can be attached. This more rigid mounting solution ensures some of the best sensor accuracy and frequency response, but is not flexible for future adjustments.
BWA-BK-002 or BWA-BK-005 Flat bracket with direct screw mount to motor and sensor	Most effective	When available, directly mounting the bracket to the motor using a ¼-28 bolt provides a rigid surface with the highest sensor accuracy and frequency response. This mounting option offers flexibility for future sensor and bracket movement.

Configuration Instructions

Sensor Configuration Tool

The Sensor Configuration Tool offers an easy way to manage sensor parameters, retrieve data, and visually show sensor data from a number of different sensors. The Sensor Configuration Tool software runs on any Windows machine and uses an adapter cable to connect the sensor to your computer.

Download the most recent version of the Sensor Configuration Tool from Banner Engineering's website: www.bannerengineering.com/wireless. The Sensor Configuration Tool currently supports the following sensors:

Sensor Type	Model	USB Adapter Cable
Temperature and Humidity	M12FTH3Q and M12FT3Q	Model BWA-HW-006: USB-to-RS-485 adapter cable OR Model BWA-UCT-900: USB to RS-485 adapter cable
	M12FTH4Q and M12FT4Q	Model BWA-USB1WIRE-001: USB-to-RS-232 1-Wire adapter cable
Vibration and Temperature	QM42VT1	Model BWA-USB1WIRE-001: USB-to-RS-232 1-Wire adapter cable
	QM42VT2	Model BWA-HW-006: USB-to-RS-485 adapter cable OR Model BWA-UCT-900: USB to RS-485 adapter cable OR When updating the firmware, you must use one of the two USB to RS-485 adapter cables plus a splitter pigtail cable p/n 83265
GPS	GPS50M	Model BWA-HW-006: USB-to-RS-485 adapter cable AND a field-wireable M12/Euro-style connector or connector with pigtail OR Model BWA-UCT-900: USB to RS-485 adapter cable AND a field-wireable M12/Euro-style connector or connector with pigtail
U-GAGE K50U Ultrasonic	K50UX1CRA	Model BWA-USB1WIRE-001: USB-to-RS-232 1-Wire adapter cable
	K50UX2CRA	Model BWA-HW-006: USB-to-RS-485 adapter cable OR Model BWA-UCT-900: USB to RS-485 adapter cable
	K50UX1ARA	Model BWA-USB1WIRE-001: USB-to-RS-232 1-Wire adapter cable
	K50UX2ARA	Model BWA-HW-006: USB-to-RS-485 adapter cable OR Model BWA-UCT-900: USB to RS-485 adapter cable

Holding Registers

By default, data is supplied to the Node every two and a half minutes, unless the Node requests the data sooner. Use the Sensor Configuration Tool to adjust the sensor's sample rate if a different value is needed. The default configuration is shown. The sensor register output data types are user configurable. Use the Sensor Configuration Tool to change the output types. All optional output types are listed below. Temperature values outside the operating range of the device are forced to the maximum or minimum values.

Sensor Register	Output Type	I/O Range		Holding Register Representation	
		Min	Max	Min (Dec)	Max (Dec)
1	Z-Axis RMS Velocity (in/sec) ^{1, 5}	0	6.5535	0	65535
2	Z-Axis RMS Velocity (mm/sec) ^{2, 5}	0	65.535	0	65535
3	Temperature (°F) ³	-1638.4	1638.3	-32768	32767
4	Temperature (°C) ³	-1638.4	1638.3	-32768	32767

Sensor Register	Output Type	I/O Range		Holding Register Representation	
		Min	Max	Min (Dec)	Max (Dec)
5	X-Axis RMS Velocity (in/sec) ^{1, 5}	0	6.5535	0	65535
6	X-Axis RMS Velocity (mm/sec) ^{2, 5}	0	65.535	0	65535

¹ Value = Register value ÷ 10000

² Value = Register value ÷ 1000

³ Value = Register value ÷ 20

⁴ Value = Register value ÷ 10

⁵ Measurement bandwidth = 10 Hz to 1 kHz

⁶ Measurement bandwidth = 1 kHz to 4 kHz

Optional Output Types

Optional Output Types	I/O Range		Holding Register Representation	
	Min	Max	Min (dec)	Max (dec)
Z-Axis Peak Acceleration (G) ^{2, 6}	0	65.535	0	65535
X-Axis Peak Acceleration (G) ^{2, 6}	0	65.535	0	65535
Z-Axis Peak Velocity Component Frequency (Hz) ^{4, 5}	0	6553.5	0	65535
X-Axis Peak Velocity Component Frequency (Hz) ^{4, 5}	0	6553.5	0	65535
Z-Axis RMS Acceleration (G) ^{2, 5}	0	65.535	0	65535
X-Axis RMS Acceleration (G) ^{2, 5}	0	65.535	0	65535
Z-Axis Kurtosis ^{2, 6}	0	65.535	0	65535
X-Axis Kurtosis ^{2, 6}	0	65.535	0	65535
Z-Axis Crest Factor ^{2, 6}	0	65.535	0	65535
X-Axis Crest Factor ^{2, 6}	0	65.535	0	65535
Z-Axis Peak Velocity (in/sec) ^{1, 5}	0	6.5535	0	65535
Z-Axis Peak Velocity (mm/sec) ^{2, 5}	0	65.535	0	65535
X-Axis Peak Velocity (in/sec) ^{1, 5}	0	6.5535	0	65535
X-Axis Peak Velocity (mm/sec) ^{2, 5}	0	65.535	0	65535
Z-Axis High-Frequency RMS Acceleration (G) ^{2, 6}	0	65.535	0	65535
X-Axis High-Frequency RMS Acceleration (G) ^{2, 6}	0	65.535	0	65535

¹ Value = Register value ÷ 10000

² Value = Register value ÷ 1000

³ Value = Register value ÷ 20

⁴ Value = Register value ÷ 10

⁵ Measurement bandwidth = 10 Hz to 1 kHz

⁶ Measurement bandwidth = 1 kHz to 4 kHz

Specifications

Supply Voltage

3.6 to 5.5 V dc

Current

Default sensing: 197 µA

Disabled sensing: 95 µA

Active comms: 3.1 mA

Communication Hardware

Interface: 1-wire serial interface

Baud rates: 9.6k, 19.2k (default), or 38.4k

Data format: 8 data bits, no parity (default), 1 stop bit (even or odd parity available)

Vibration Sensor

Mounted base resonance: 4.5 kHz nominal

Measuring Range: 0 to 46 mm/sec or 0 to 1.8 in/sec RMS

Frequency Range: 10 Hz to 4 kHz

Accuracy: ±10% at 25 °C

Sampling Frequency: 20 kHz (default)

Record Length: 8192 points (default)

Sample Duration: 0.4 s (default)

Indicators

Green flashing: Power ON

Amber flicker: Serial Tx

Communication Protocol

Sure Cross DX80 Sensor Node 1-Wire Serial Interface

Communications Line

Level Receive ON: Greater than 2 V
 Level Receive OFF: Less than 0.7 V
 Level Transmit ON: 2.7 to 3 V
 Level Transmit OFF: 0 V (pulldown resistor of 10 kOhm)

Compatible Nodes

900 MHz Models

DX80N9X1S-P6
 DX80N9X6S-P6
 DX80DR9M-H6 and -H6L
 DX80N9Q45VT

2.4 GHz Models

DX80N2X1S-P6
 DX80N2X6S-P6
 DX80DR2M-H6 and -H6L
 DX80N2Q45VT

Temperature Sensor

Measuring Range: -40 °C to +105 °C (-40 °F to +221 °F)
 Resolution: 1 °C
 Accuracy: ± 3 °C

Environmental Rating

NEMA 6P, IEC IP67

Operating Temperature

-40 °C to +105 °C (-40 °F to +221 °F)[¶]

Shock

400G

Mounting Options

The VT1 sensor can be mounted using a variety of methods, including 1/4"-28 hex screw, epoxy, thermal tape, or magnetic mount.

Certifications



Battery Life for a P6 Node Connected to a Vibration and Temperature (VT1) Sensor

The following battery life estimates use the default configuration of the Performance P6 Node, which is a 5 minute sample and report rate.

- 900 MHz 1 Watt: 2.5 years
- 900 MHz 250 mW: 3.4 years
- 2.4 GHz: 4.3 years

Battery Life for a Q45VA or a Q45VT/Q45U Node with 1-Wire Serial Sensor

This is the battery life curve for the following models:

- Q45VT or Q45U 1-Wire Serial Interface Node connected to a 1-wire serial sensor (such as a VT1 Vibration/Temperature sensor)
- Q45VA All-in-One Sensor Node

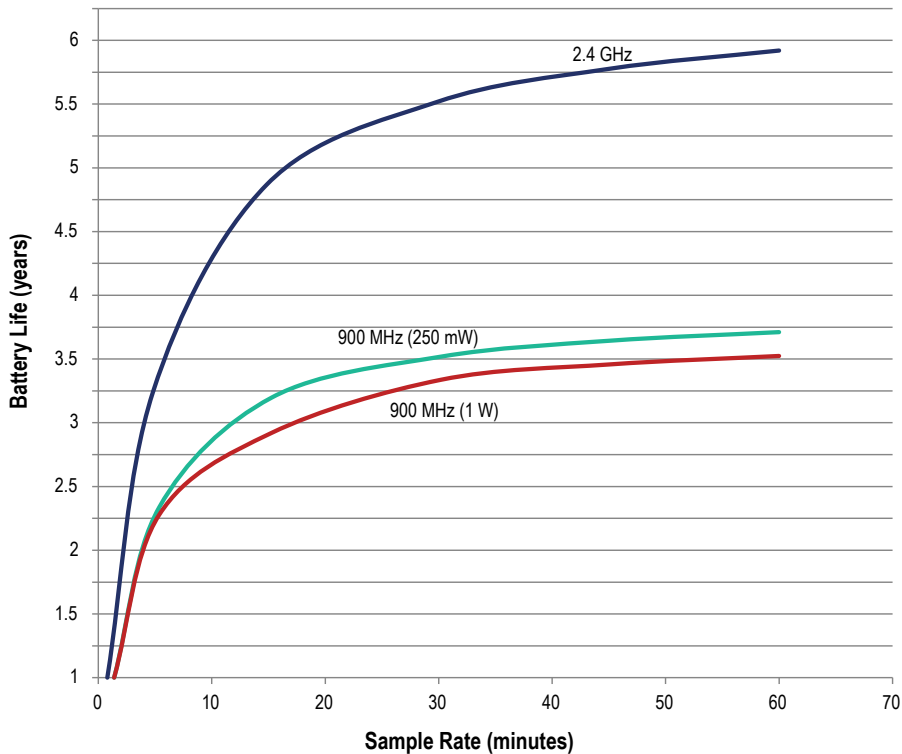

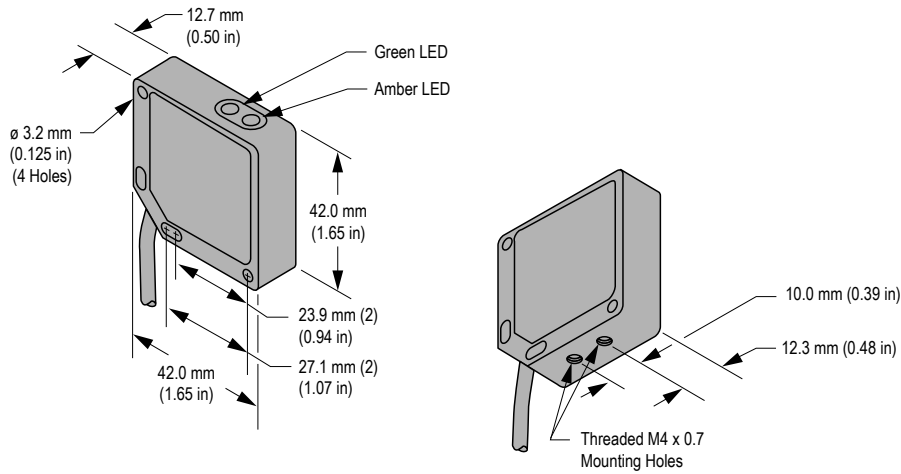

[¶] Operating the devices at the maximum operating conditions for extended periods can shorten the life of the device.

Dimensions

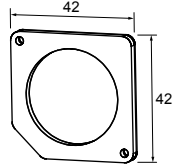

Accessories for the Vibration and Temperature Sensor

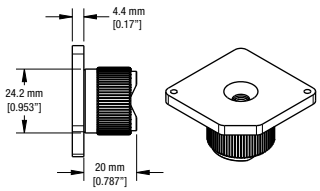
Included with Sensor	Available for Order
<p>BWA-BK-005</p> <ul style="list-style-type: none"> Use when measuring high frequency vibrations or when mounting the sensor to curved surfaces Includes SMB42FLAT stainless steel bracket, 1/4"-28 screw mount, and 1 piece of 3M™ thermally conductive adhesive transfer tape 	<p>BWA-BK-001</p> <ul style="list-style-type: none"> Includes magnetic mounting bracket SMB42FLM12 and 2 mounting screws 
<p>BWA-HW-057</p> <ul style="list-style-type: none"> 3M™ Thermally Conductive Adhesive Transfer Tape 8820 Provides a heat-transfer path between heat-generating components and heat sinks or other cooling devices 3 pieces per pack Tape is 20 mils (0.50 mm) thick; liner is 1.5-2 mil (37.5-50 µm) thick Thermally conductive ceramic filler Dual liner using silicone-treated polyester: easy-release PET liner is clear, tight side PET liner is blue 	<p>BWA-USB1WIRE-001</p> <ul style="list-style-type: none"> PC USB to 1-wire serial interface converter Use with the Sensor Configuration Tool software to communicate directly with 1-wire serial interface sensors Datasheet: 170020 
	<p>BWA-BK-008</p> <ul style="list-style-type: none"> Magnetic coaxial mount for round objects Includes SMB42FLAT stainless steel bracket, 1/4"-28 screw mount, and 1 piece of 3M™ thermally conductive adhesive transfer tape 42 mm x 42 mm 

Banner Engineering Corp. Limited Warranty

Banner Engineering Corp. warrants its products to be free from defects in material and workmanship for one year following the date of shipment. Banner Engineering Corp. will repair or replace, free of charge, any product of its manufacture which, at the time it is returned to the factory, is found to have been defective during the warranty period. This warranty does not cover damage or liability for misuse, abuse, or the improper application or installation of the Banner product.

THIS LIMITED WARRANTY IS EXCLUSIVE AND IN LIEU OF ALL OTHER WARRANTIES WHETHER EXPRESS OR IMPLIED (INCLUDING, WITHOUT LIMITATION, ANY WARRANTY OF MERCHANTABILITY OR FITNESS FOR A PARTICULAR PURPOSE), AND WHETHER ARISING UNDER COURSE OF PERFORMANCE, COURSE OF DEALING OR TRADE USAGE.

This Warranty is exclusive and limited to repair or, at the discretion of Banner Engineering Corp., replacement. **IN NO EVENT SHALL BANNER ENGINEERING CORP. BE LIABLE TO BUYER OR ANY OTHER PERSON OR ENTITY FOR ANY EXTRA COSTS, EXPENSES, LOSSES, LOSS OF PROFITS, OR ANY INCIDENTAL, CONSEQUENTIAL OR SPECIAL DAMAGES RESULTING FROM ANY PRODUCT DEFECT OR FROM THE USE OR INABILITY TO USE THE PRODUCT, WHETHER ARISING IN CONTRACT OR WARRANTY, STATUTE, TORT, STRICT LIABILITY, NEGLIGENCE, OR OTHERWISE.**

Banner Engineering Corp. reserves the right to change, modify or improve the design of the product without assuming any obligations or liabilities relating to any product previously manufactured by Banner Engineering Corp. Any misuse, abuse, or improper application or installation of this product or use of the product for personal protection applications when the product is identified as not intended for such purposes will void the product warranty. Any modifications to this product without prior express approval by Banner Engineering Corp will void the product warranties. All specifications published in this document are subject to change; Banner reserves the right to modify product specifications or update documentation at any time. Specifications and product information in English supersede that which is provided in any other language. For the most recent version of any documentation, refer to: www.bannerengineering.com.



more sensors, more solutions