

### Universal MicroMod Connector

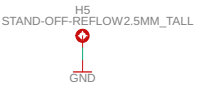

### LED

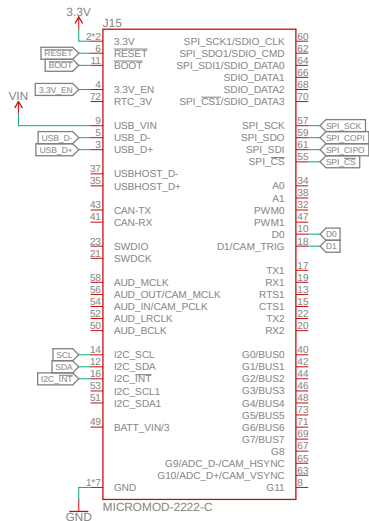
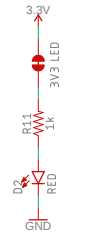

Cut this jumper to remove power LED.

### Voltage Regulation

This is the penny-in-the-fuse jumper. Close only if you know what you're doing.

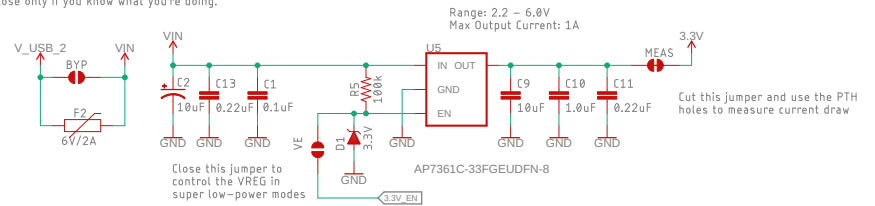

### Battery Charger

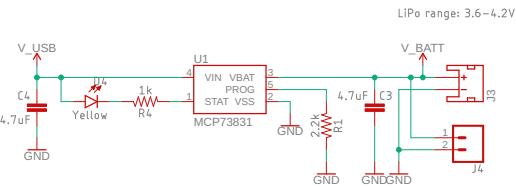

### Power Source Select

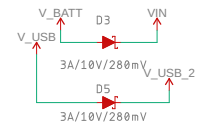

### Test Points



Released under the Creative Commons Attribution Share-Alike 4.0 License <https://creativecommons.org/licenses/by-sa/4.0/>

TITLE: MM-Qwiic-Carrier-Single

Design by: Priyanka Makin

Date: 3/8/2021 8:58 AM

REV: v1.0

Sheet: 1/1

### USB-C

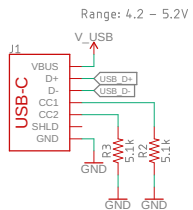

### Qwiic Connector

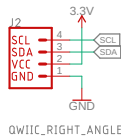

QWIIC\_RIGHT\_ANGLE

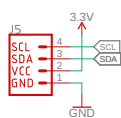

Vertical Qwiic Connector

Qwiic bus conservative max current: 226mA

### Buttons

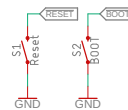

### Header



### Qwiic Stand offs

Qwiic Board Outline