

4A, 400V - 1000V Standard Bridge Rectifier

FEATURES

- Ideal for printed circuit board
- Reliable low cost construction utilizing molded plastic technique
- High surge current capability
- UL Recognized File # E-326243
- RoHS Compliant
- Halogen-free according to IEC 61249-2-21

APPLICATIONS

- Switching mode power supply
- Adapters
- Lighting application

MECHANICAL DATA

- Case: KBPF
- Molding compound meets UL 94V-0 flammability rating
- Terminal: Matte tin plated leads, solderable per J-STD-002
- Polarity: As marked
- Weight: 1.40g (approximately)

KEY PARAMETERS		
PARAMETER	VALUE	UNIT
I_F	4	A
V_{RRM}	400 - 1000	V
I_{FSM}	120	A
$T_{J\ MAX}$	150	°C
Package	KBPF	
Configuration	Quad	

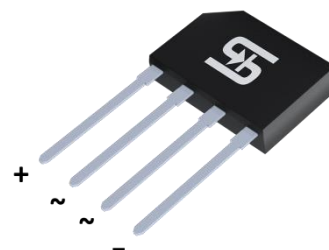
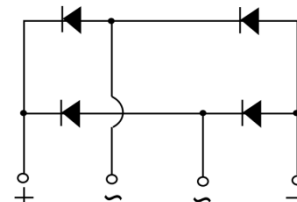
KBPF

ABSOLUTE MAXIMUM RATINGS ($T_A = 25^\circ\text{C}$ unless otherwise noted)

PARAMETER	SYMBOL	KBPF 404G	KBPF 405G	KBPF 406G	KBPF 407G	UNIT
Marking code on the device		KBPF 404G	KBPF 405G	KBPF 406G	KBPF 407G	
Repetitive peak reverse voltage	V_{RRM}	400	600	800	1000	V
Reverse voltage, total rms value	$V_{R(RMS)}$	280	420	560	700	V
Forward current	I_F	4				A
Surge peak forward current, 8.3ms single half sine-wave superimposed on rated load	I_{FSM}	120				A
Rating for fusing ($t < 8.3\text{ms}$)	I^2t	60				A^2s
Junction temperature	T_J	- 55 to +150				°C
Storage temperature	T_{STG}	- 55 to +150				°C

THERMAL PERFORMANCE			
PARAMETER	SYMBOL	TYP	UNIT
Junction-to-lead thermal resistance	$R_{\theta JL}$	12	°C/W
Junction-to-ambient thermal resistance	$R_{\theta JA}$	56	°C/W
Junction-to-case thermal resistance	$R_{\theta JC}$	13	°C/W

Thermal Performance Note: Units mounted on PCB (10mm x 10mm Cu pad test board)

ELECTRICAL SPECIFICATIONS ($T_A = 25^\circ\text{C}$ unless otherwise noted)					
PARAMETER	CONDITIONS	SYMBOL	TYP	MAX	UNIT
Forward voltage per diode ⁽¹⁾	$I_F = 2\text{A}, T_J = 25^\circ\text{C}$	V_F	-	1.1	V
	$I_F = 2\text{A}, T_J = 125^\circ\text{C}$		-	1.0	V
Reverse current @ rated V_R per diode ⁽²⁾	$T_J = 25^\circ\text{C}$	I_R	-	5	μA
	$T_J = 125^\circ\text{C}$		-	200	μA
Junction capacitance per diode	1MHz, $V_R = 4.0\text{V}$	C_J	39	-	pF

Notes:

1. Pulse test with $PW = 0.3\text{ms}$
2. Pulse test with $PW = 30\text{ms}$

ORDERING INFORMATION		
ORDERING CODE⁽¹⁾	PACKAGE	PACKING
KBPF4xG	KBPF	35 / Tube

Notes:

1. "x" defines voltage from 400V(KBPF404G) to 1000V(KBPF407G)

CHARACTERISTICS CURVES

($T_A = 25^\circ\text{C}$ unless otherwise noted)

Fig.1 Forward Current Derating Curve

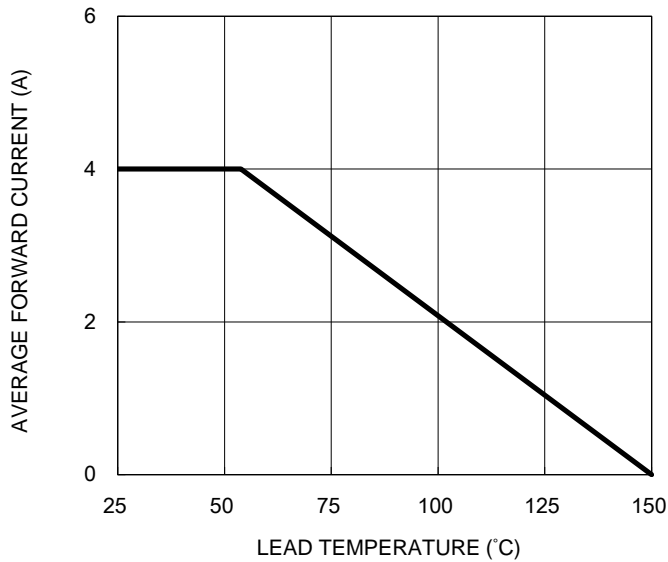

Fig.2 Typical Junction Capacitance

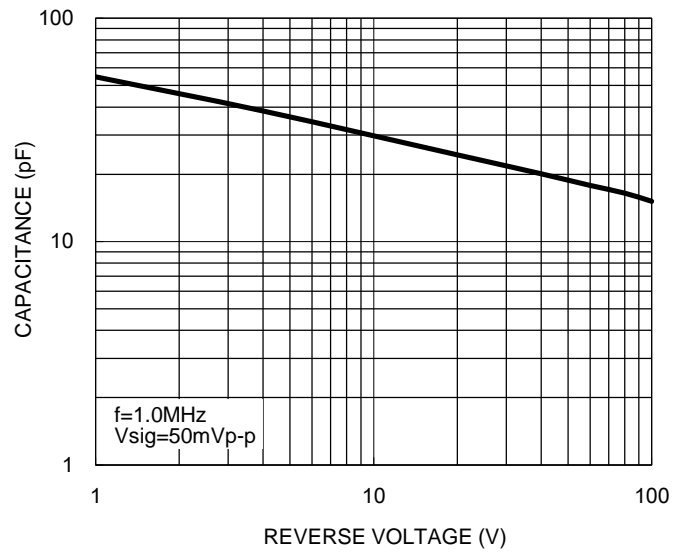

Fig.3 Typical Reverse Characteristics

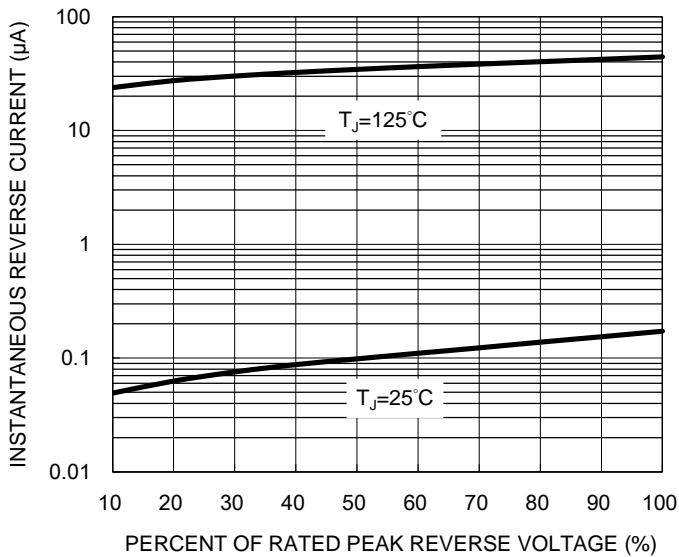
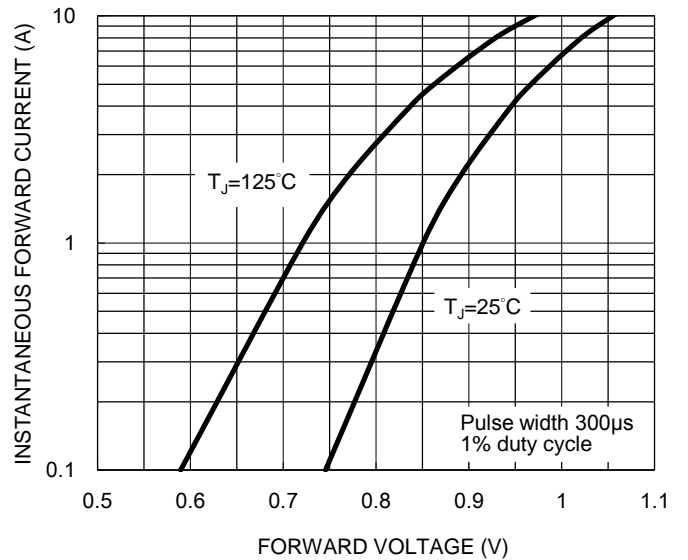
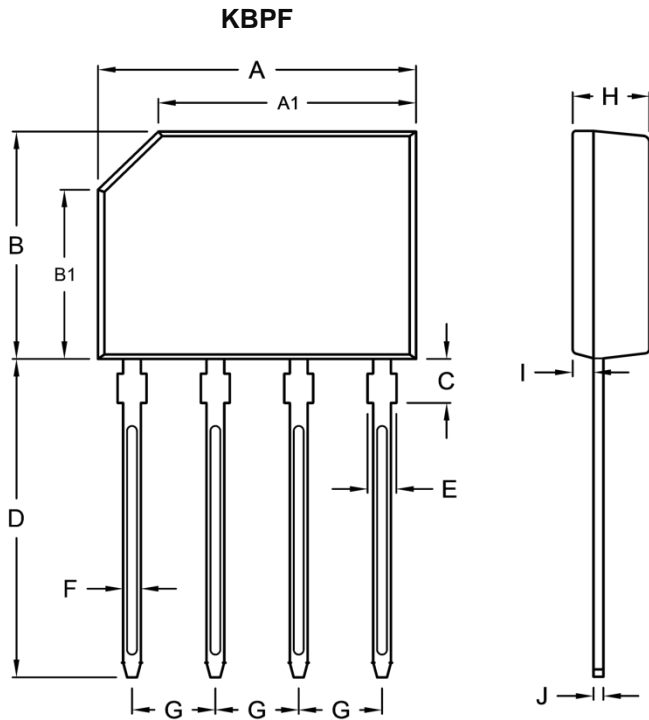

Fig.4 Typical Forward Characteristics



PACKAGE OUTLINE DIMENSIONS



DIM.	Unit (mm)		Unit (inch)	
	Min.	Max.	Min.	Max.
A	14.25	14.75	0.561	0.581
A1	11.45	12.05	0.451	0.474
B	10.10	10.60	0.398	0.417
B1	7.40	8.00	0.291	0.315
C	1.80	2.20	0.071	0.087
D	14.25	14.73	0.561	0.580
E	1.22	1.42	0.048	0.056
F	0.76	0.86	0.030	0.034
G	3.70	3.90	0.146	0.154
H	3.35	3.65	0.132	0.144
I	0.80	1.10	0.031	0.043
J	0.35	0.55	0.014	0.022

MARKING DIAGRAM



- P/N = Marking Code
- G = Green Compound
- YWW = Date Code
- F = Factory Code

Notice

Specifications of the products displayed herein are subject to change without notice. TSC or anyone on its behalf, assumes no responsibility or liability for any errors or inaccuracies.

Purchasers are solely responsible for the choice, selection, and use of TSC products and TSC assumes no liability for application assistance or the design of Purchasers' products.

Information contained herein is intended to provide a product description only. No license, express or implied, to any intellectual property rights is granted by this document. Except as provided in TSC's terms and conditions of sale for such products, TSC assumes no liability whatsoever, and disclaims any express or implied warranty, relating to sale and/or use of TSC products including liability or warranties relating to fitness for a particular purpose, merchantability, or infringement of any patent, copyright, or other intellectual property right.

The products shown herein are not designed for use in medical, life-saving, or life-sustaining applications. Customers using or selling these products for use in such applications do so at their own risk and agree to fully indemnify TSC for any damages resulting from such improper use or sale.