

Linear Fan Driver

General Description

The RT9027A/B is a high performance positive voltage regulator designed for very low dropout voltage up to 0.5 Amps. The V_{SET} voltage must be larger than 1V to guarantee that V_{OUT} is 1.6 times of V_{SET} . When V_{SET} is less than 1V, the IC will be shutdown. The \overline{FON} pin turns V_{OUT} to fully-on when \overline{FON} is given low. For RT9027B (EN version), \overline{FON} pin is equivalent to EN pin. The RT9027A/B provides excellent regulation over variations in line, load and temperature. The RT9027A/B is available in the SOP-8 package.

Ordering Information

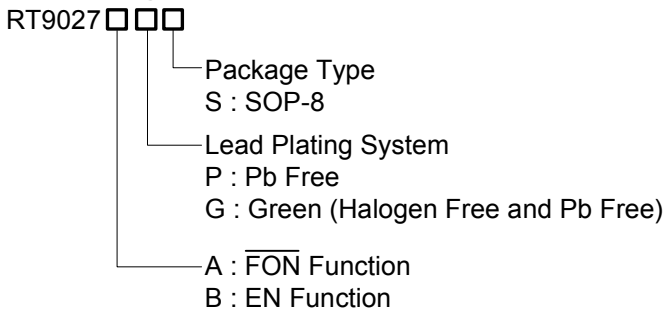

Note :

Richtek products are :

- ▶ RoHS compliant and compatible with the current requirements of IPC/JEDEC J-STD-020.
- ▶ Suitable for use in SnPb or Pb-free soldering processes.

Typical Application Circuit

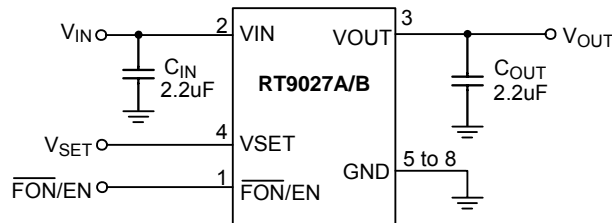

Features

- V_{OUT} Follows 1.6 Times of V_{SET}
- 150mV Dropout @ 0.5A
- Over Current and Over Temperature Protection
- \overline{FON} Pin Turns V_{OUT} Fully On
- RoHS Compliant and 100% Lead (Pb)-Free

Applications

- Notebook Computer Fan Driver
- Battery Powered System
- Motherboard
- Peripheral Card

Pin Configurations

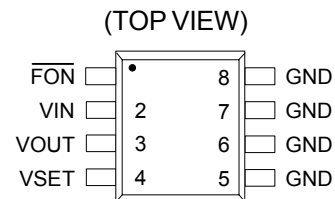

RT9027A

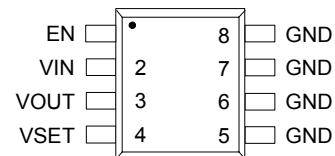

RT9027B

SOP-8

Functional Pin Description

Pin No.	Pin Name	Pin Function
1	$\overline{\text{FON}}$	Internal pulled high. For RT9027A, the IC will be fully turned on when this pin's voltage is below 0.4V.
	EN	Internal pulled high. For RT9027B, the IC will be shutdown when this pin's voltage is below 0.4V.
2	VIN	Input Voltage Pin.
3	VOUT	Output Voltage Pin.
4	VSET	This pin is used for output voltage setting. It is necessary to make this pin higher than 1V to guarantee V_{OUT} to be 1.6 times of VSET. The IC will be shutdown when this pin voltage is below 1V.
5 to 8	GND	Ground.

Function Block Diagram

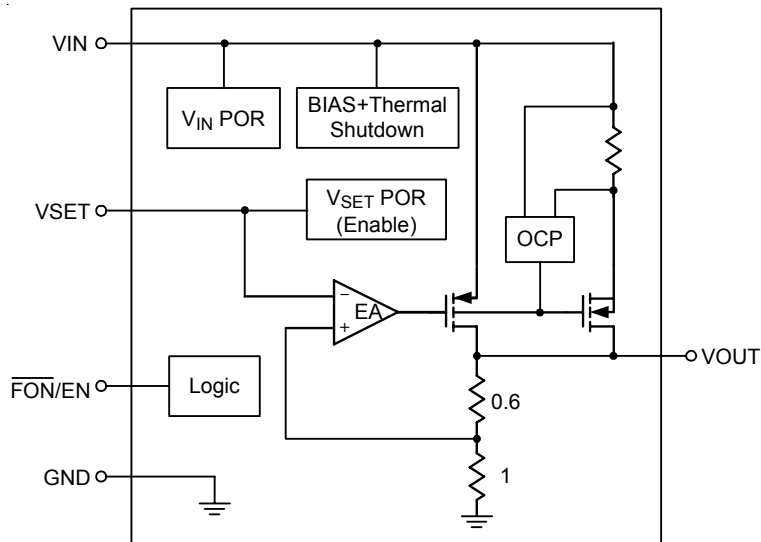

Absolute Maximum Ratings (Note 1)

- Supply Input Voltage, V_{IN} ----- 6V
- EN, \overline{FON} , VSET Voltage ----- 6V
- Power Dissipation, $P_D @ T_A = 25^\circ C$
 SOP-8 ----- 1.053W
- Package Thermal Resistance (Note 2)
 SOP-8, θ_{JA} ----- 95°C/W
- Lead Temperature (Soldering, 10 sec.) ----- 260°C
- Junction Temperature ----- 150°C
- Storage Temperature Range ----- -65°C to 150°C
- ESD Susceptibility (Note 3)
 HBM ----- 2kV
 MM ----- 200V

Recommended Operating Conditions (Note 4)

- Supply Input Voltage, V_{IN} ----- 4.5V to 5.5V
- Junction Temperature Range ----- -40°C to 125°C
- Ambient Temperature Range ----- -40°C to 85°C

Electrical Characteristics

($V_{SET} = 2V, V_{IN} = 5V, I_{OUT} = 0.5A, C_{IN} = C_{OUT} = 2.2\mu F, T_A = 25^\circ C$, unless otherwise specified)

Parameter		Symbol	Test Conditions	Min	Typ	Max	Unit
Input Voltage							
Input Voltage Range		V_{IN}		4.5	--	5.5	V
Quiescent Current		I_Q	$I_{OUT} = 0A$	--	300	--	μA
Shutdown Current	RT9027A	I_{SHDN}	$V_{SET} = 0V$	--	10	--	μA
	RT9027B		$V_{EN} = 0V$	--	10	--	
Output Voltage							
V_{OUT}/V_{SET}				1.552	1.6	1.648	V
Line Regulation		ΔV_{LINE}		--	0.2	0.5	%
Load Regulation		ΔV_{LOAD}		--	0.2	0.8	
R_{ON}			$I_{OUT} = 0.5A, V_{IN} = 5V, V_{SET} = 3.3V$	--	0.15	0.3	Ω
Current Limit		I_{LIM}		1.6	2	3.5	A
Short Current		I_{SC}		--	1.1	--	A
V_{IN} UVLO Threshold			Rising	--	2.5	--	V
V_{IN} UVLO Hysteresis				--	0.7	--	
V_{SET} UVLO Threshold			Rising	--	0.8	--	V
V_{SET} UVLO Hysteresis				--	0.1	--	

To be continued

Parameter	Symbol	Test Conditions	Min	Typ	Max	Unit
FON Function (RT9027A)						
FON Threshold	Logic-Low Voltage		--	--	0.4	V
	Logic-High Voltage		1.6	--	--	V
FON Bias Pin Current		$V_{FON} = 0$	--	1.5	15	uA
EN Function (RT9027B)						
EN Threshold	Logic-Low Voltage	V_{IL}	--	--	0.4	V
	Logic-High Voltage	V_{IH}	1.6	--	--	V
EN Bias Pin Current	I_{EN}	$V_{EN} = 0$	--	10	15	uA
Over Temperature Protection						
Thermal Shutdown Temperature	T_{SD}		--	140	--	°C
Thermal Shutdown Hysteresis			--	30	--	°C

Note 1. Stresses listed as the above “Absolute Maximum Ratings” may cause permanent damage to the device. These are for stress ratings. Functional operation of the device at these or any other conditions beyond those indicated in the operational sections of the specifications is not implied. Exposure to absolute maximum rating conditions for extended periods may remain possibility to affect device reliability.

Note 2. θ_{JA} is measured in the natural convection at $T_A = 25^\circ\text{C}$ on a high effective four layers thermal conductivity test board of JEDEC 51-7 thermal measurement standard.

Note 3. Devices are ESD sensitive. Handling precaution is recommended.

Note 4. The device is not guaranteed to function outside its operating conditions.

Typical Operating Characteristics

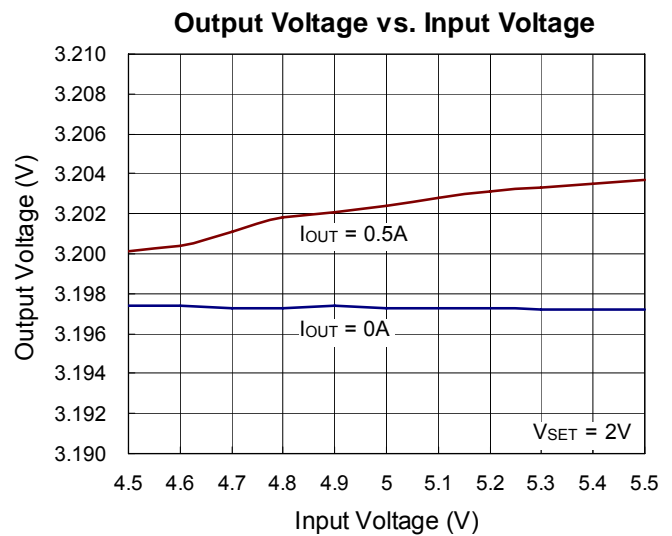
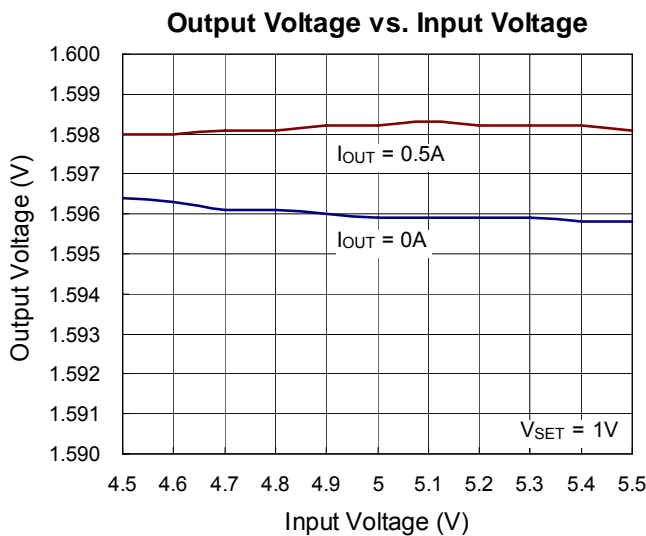
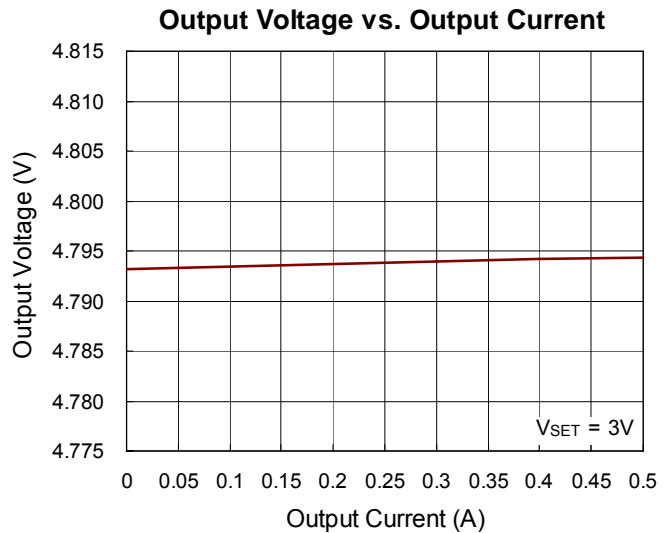
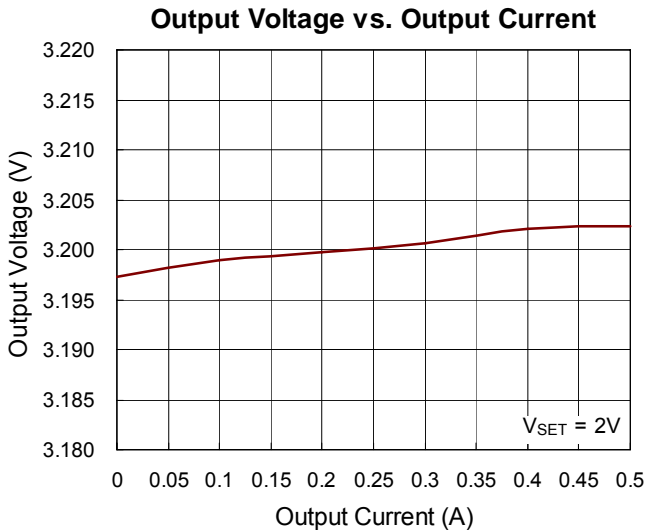
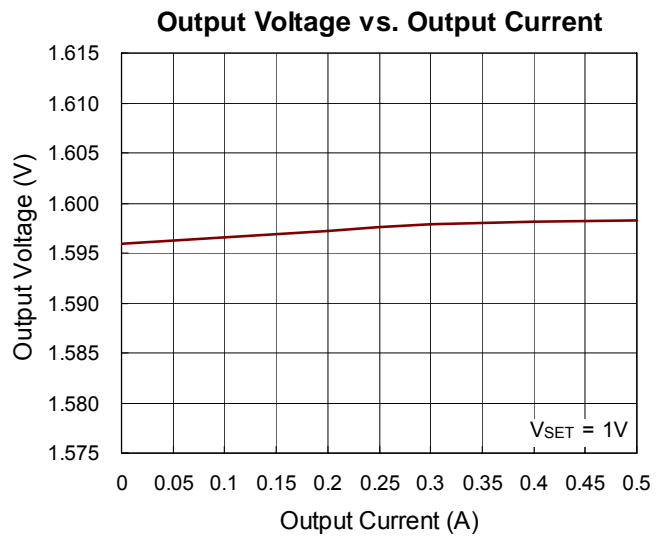
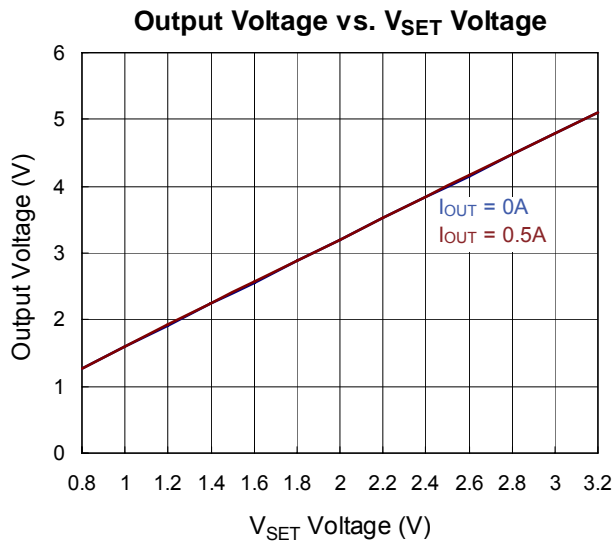

Output Voltage vs. Temperature

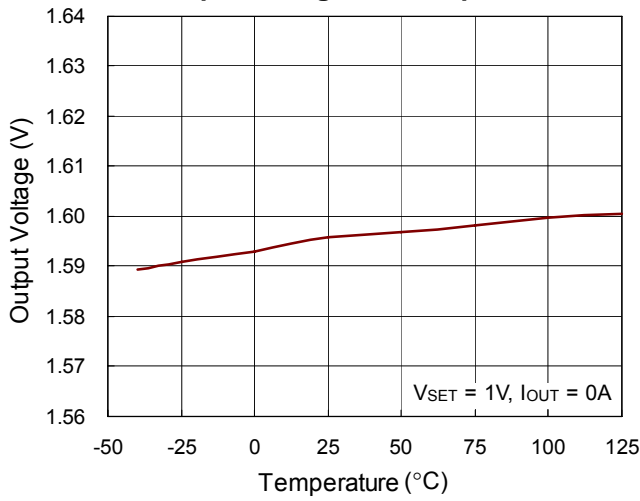

Output Voltage vs. Temperature

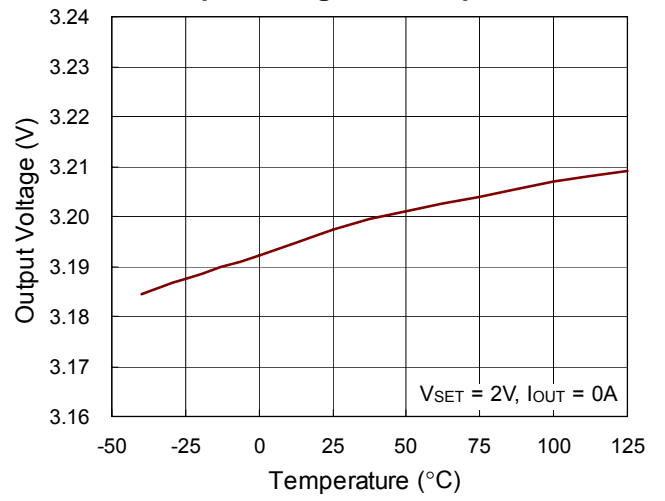

Output Voltage vs. Temperature

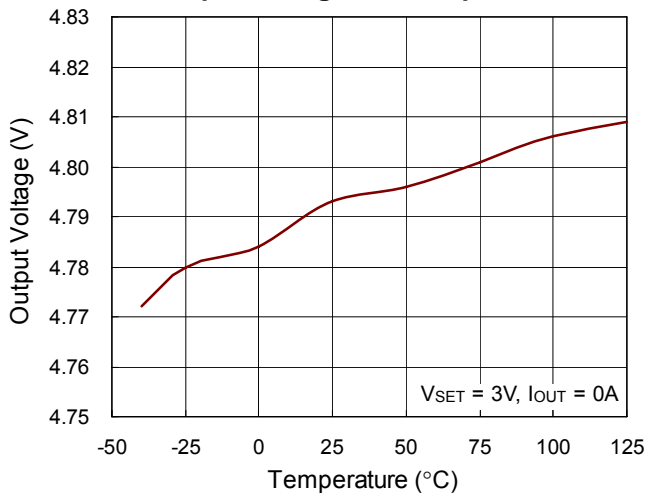

V_{IN} UVLO Threshold vs. Temperature

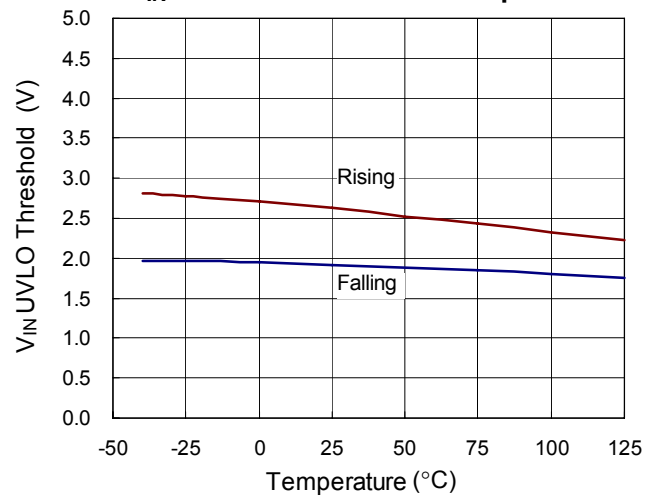

VSET Threshold vs. Temperature

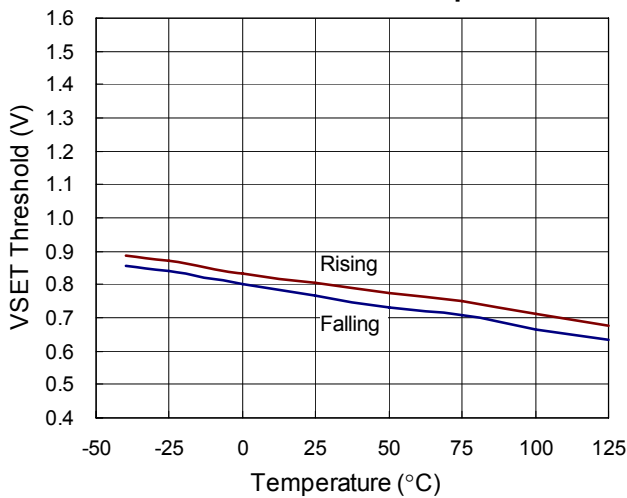

EN Threshold vs. Temperature

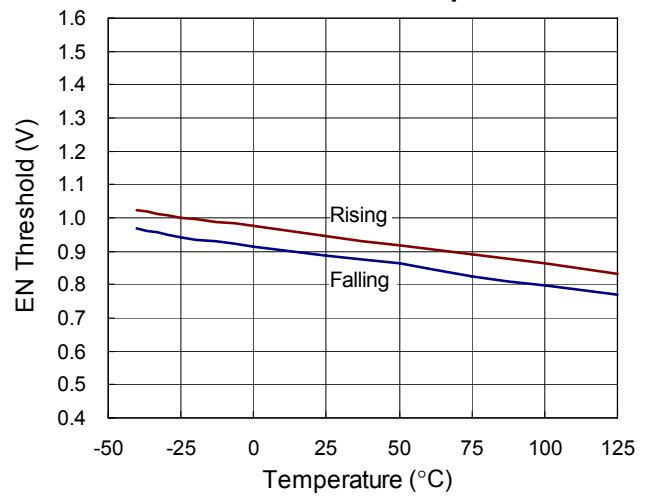

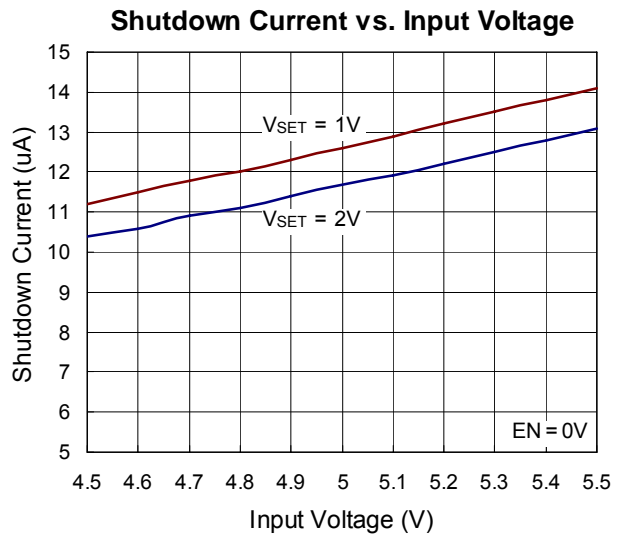
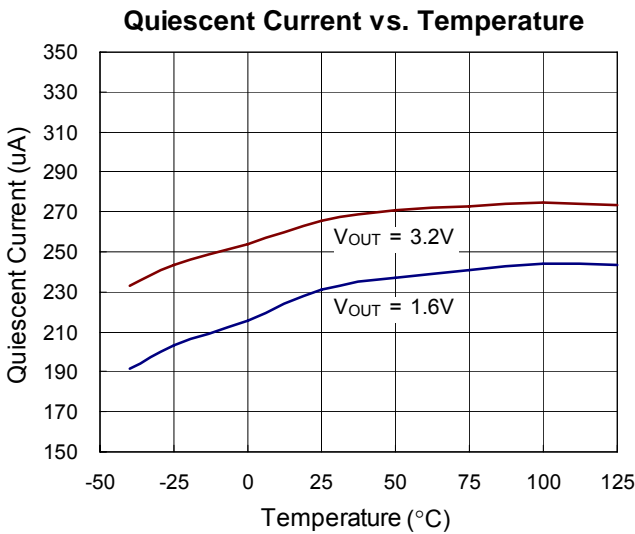
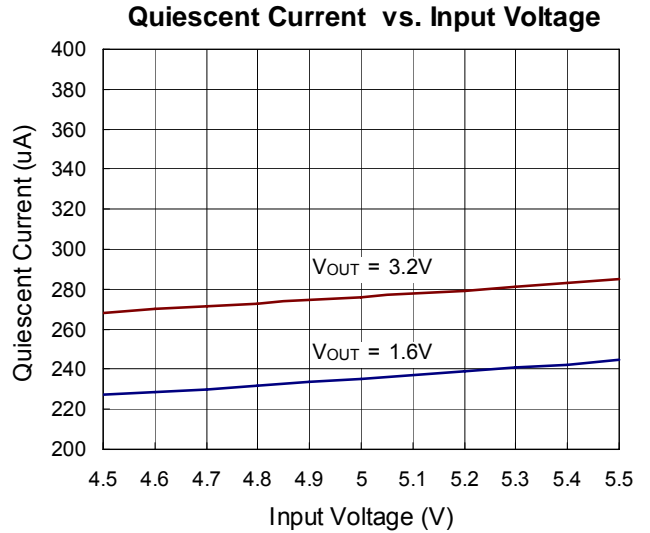
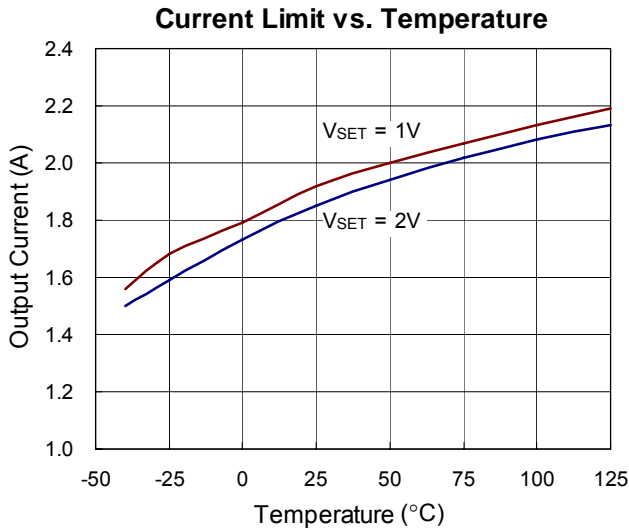
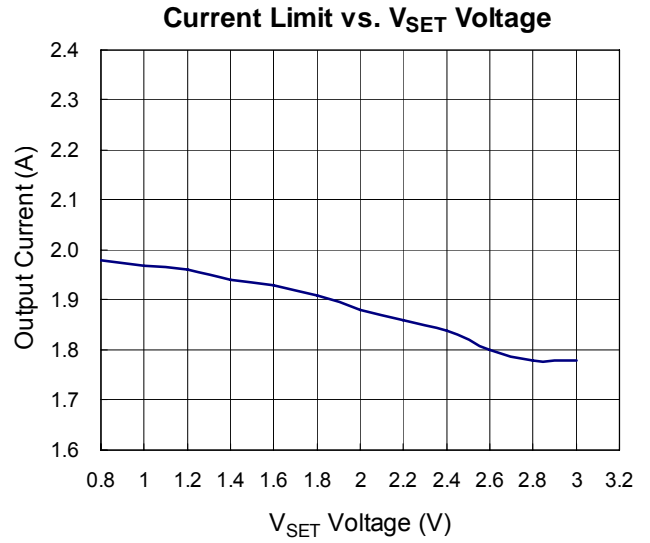
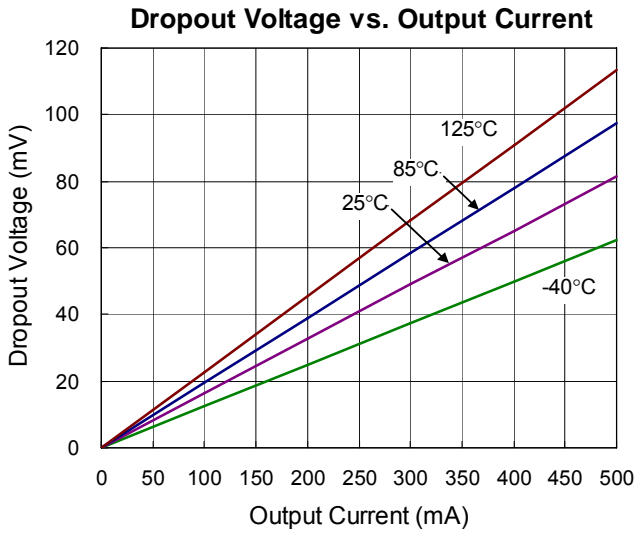

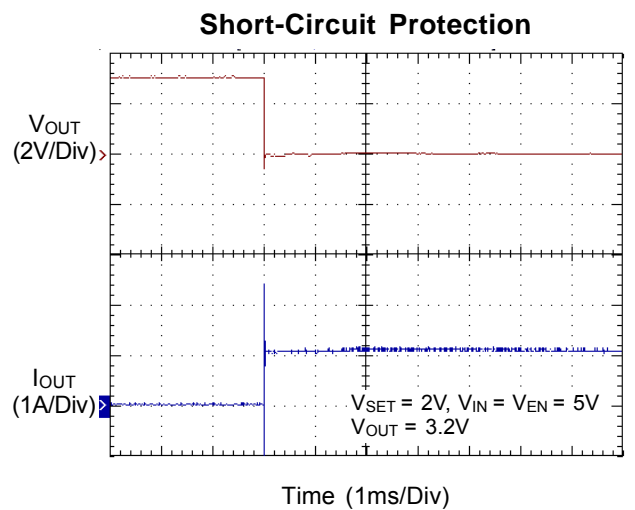
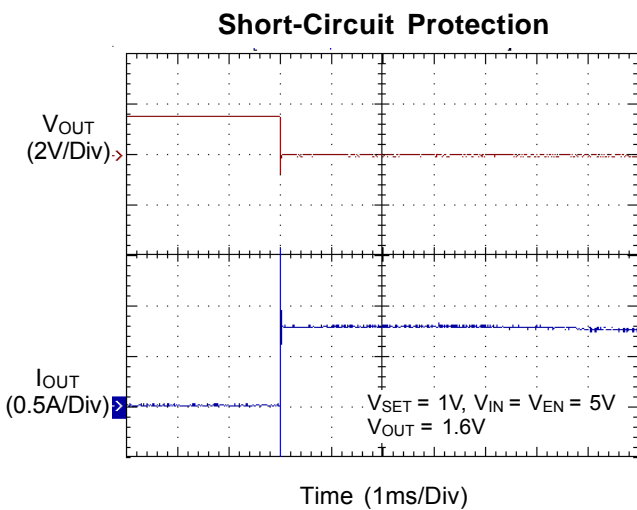
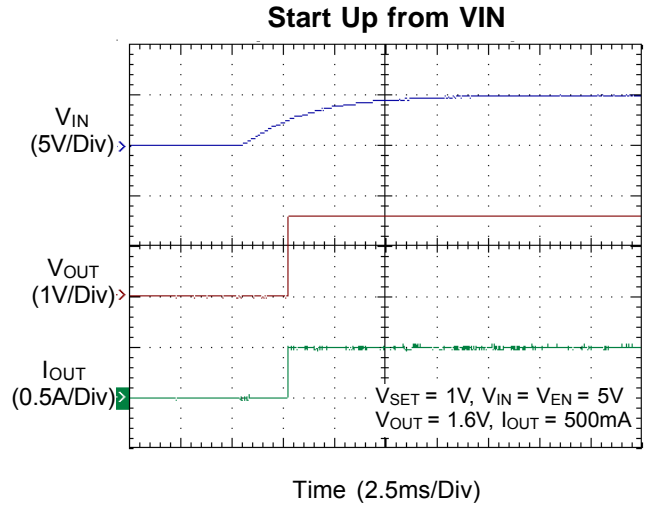
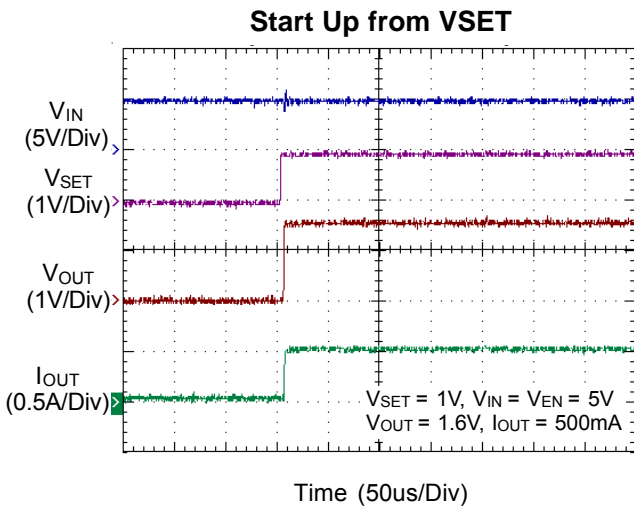
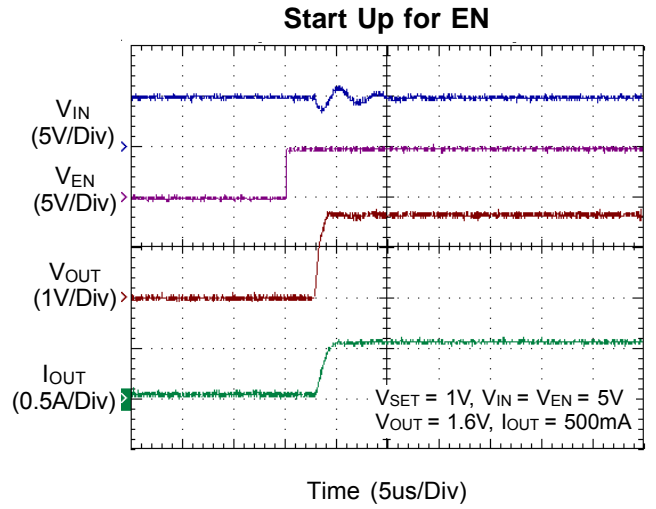
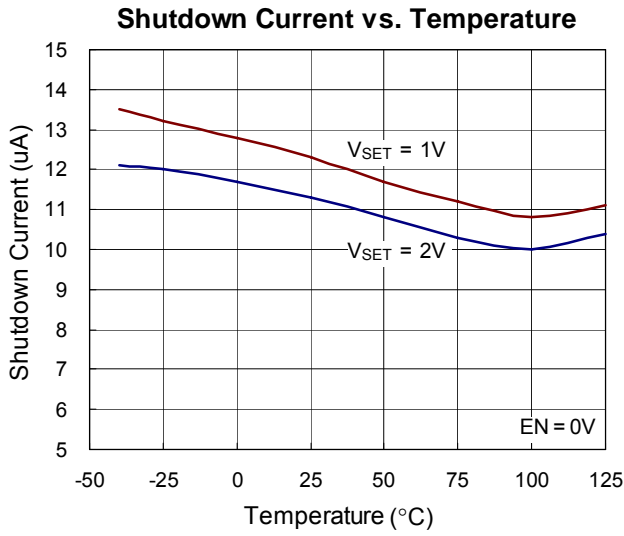

Line Transient Response

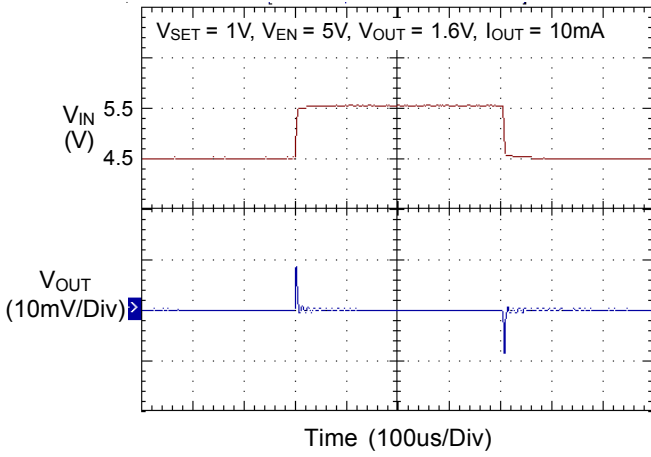

Line Transient Response

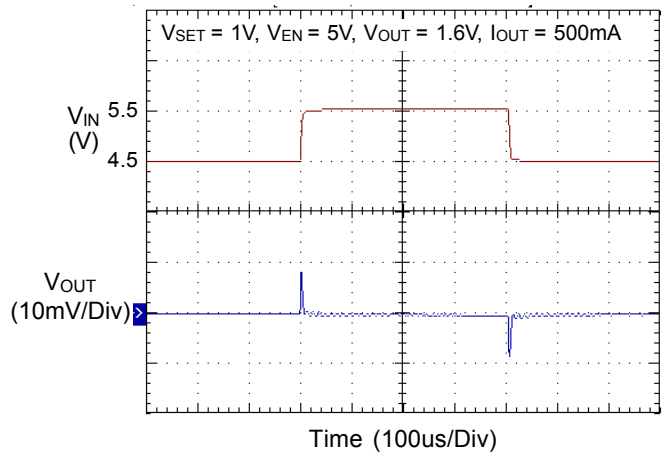

Line Transient Response

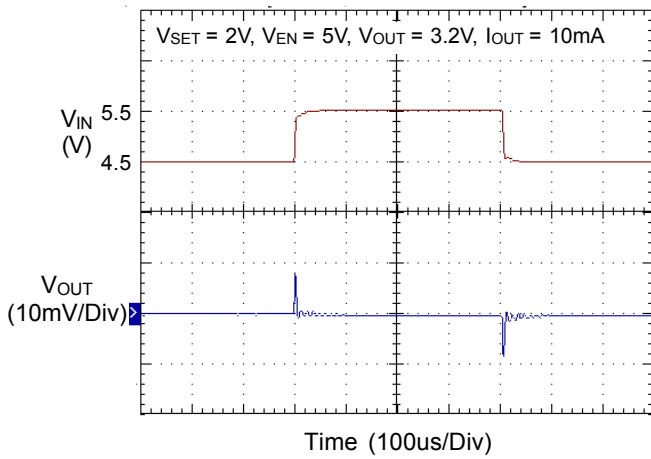

Line Transient Response

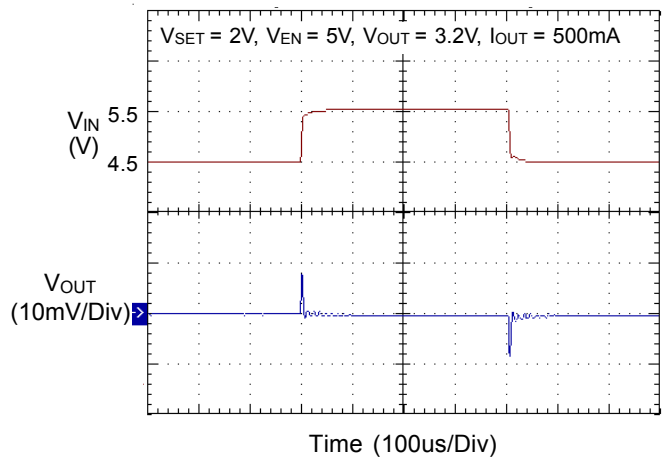

Load Transient Response

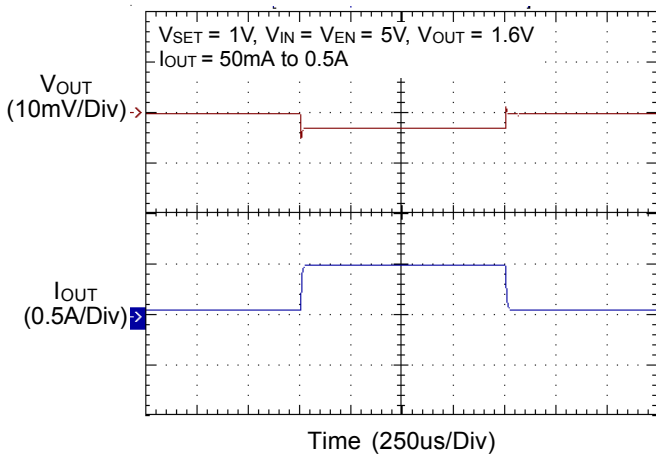

Load Transient Response

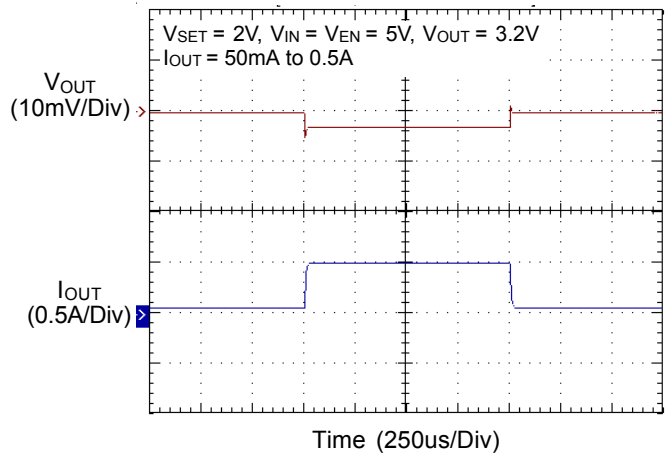

Application Information

Output Voltage Setting

The output voltage of RT9027AB is adjustable from 1.6V to VIN by VSET voltage. It is set by internal voltage divider resistors shown in function block diagram. The VOUT voltage level is set as 1.6 times of VSET voltage level when VSET is higher than 1V. When VSET is less than 0.8V, the IC will be shutdown.

Fully Turn On and Enable Logic Function

For RT9027A, pin1 named FON features fully turn on function. When the FON pin is in logic low level, the IC goes into fully turn on mode. During this condition, the pass transistor will be fully turned on. The FON pin is pulled to high level internally. For the enable function, it is acceptable to use the VSET pin to control the IC. When the VSET pin is in logic low level (<0.8V), the IC will be shutdown.

For RT9027B, there is an EN pin for power on/off control. When the EN pin is in logic low level, the IC will be shutdown. During this condition, the pass transistor, error amplifier, and band gap are turned off, reducing the supply current to 10uA typical. The IC goes into operation mode when the EN pin is in logic high level condition. The EN pin is pulled to high level internally.

Capacitor Selection

Good bypassing is recommended from input to ground to improve the AC performance. A 2.2uF input ceramic capacitor or greater located as close as possible to the IC is recommended. The RT9027AB is specifically designed to use ceramic output capacitors as low as 2.2uF. The ceramic capacitors offer significant cost and space savings, along with high frequency noise filtering.

Current Limit and Short Circuit Protection

The RT9027A contains an independent current limit and short circuit current protection to prevent the IC from damaging in unexpected applications. The current limit monitors and controls the pass transistor's gate voltage, limiting the output current to a certain level (2A typ.). When the output voltage is less than 0.4V, the short circuit current protection starts the current fold back function and limits the output current at 0.8A (typ.).

Thermal Shutdown Protection

RT9027AB over temperature protection function limits power dissipation to prevent this die from over temperature damage. When the RT9027B operation junction temperature exceeds 140°C, the over temperature protection circuit starts the thermal shutdown function and turns the pass transistor off. The pass transistor turns on again after the junction temperature cools by 30°C. For RT9027A, it lowers its OTP trip level to 110°C. It limits IC case temperature under 100°C and provides maximum safety to customer while output short circuit occurring.

Thermal Considerations

For continuous operation, do not exceed absolute maximum operation junction temperature 125°C. The power dissipation definition in device is:

$$P_D = (V_{IN} - V_{OUT}) \times I_{OUT} + V_{IN} \times I_Q$$

The maximum power dissipation depends on the thermal resistance of IC package, PCB layout, the rate of surroundings airflow and temperature difference between junction to ambient. The maximum power dissipation can be calculated by following formula :

$$P_{D(MAX)} = (T_{J(MAX)} - T_A) / \theta_{JA}$$

Where $T_{J(MAX)}$ is the maximum operation junction temperature 125°C, T_A is the ambient temperature and the θ_{JA} is the junction to ambient thermal resistance. For recommended operating conditions specification of RT9027A/B, where $T_{J(MAX)}$ is the maximum junction temperature of the die (125°C) and T_A is the maximum ambient temperature.

Since the multiple GND pins of the SOP-8 package are internally shorted and connected to lead frame, it is efficient to dissipate the heat by adding copper area on GND footprint. Figure 1 shows the relation about thermal resistance θ_{JA} vs. copper area on a standard JEDEC 51-7 (4 layer, 2S2P) thermal test board at $T_A = 25^\circ\text{C}$. For example, with 10mm x 10mm copper area PCB, we can obtain the lower thermal resistance about 45°C/W.

The maximum power dissipation at $T_A = 25^\circ\text{C}$ can be calculated by following formula :

$$P_{D(\text{MAX})} = (125^\circ\text{C} - 25^\circ\text{C}) / 45^\circ\text{C/W} = 2.22\text{W for SOP-8 package}$$

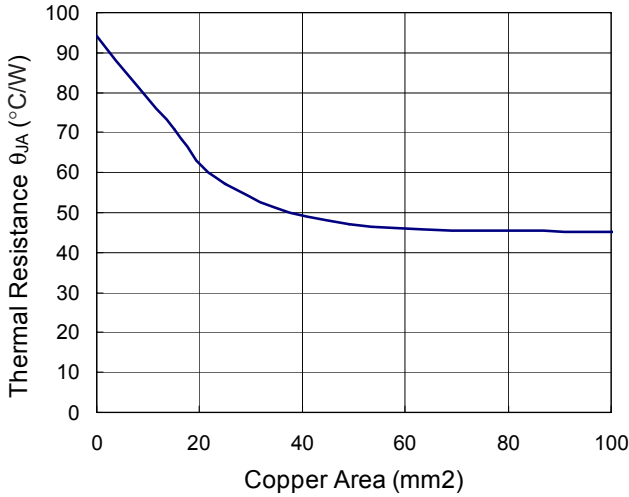

Figure 1

The maximum power dissipation depends on operating ambient temperature for fixed $T_{J(\text{MAX})}$ and thermal resistance θ_{JA} . For RT9027AB packages, the Figure 2 of de-rating curves allows the designer to see the effect of rising ambient temperature on the maximum power allowed.

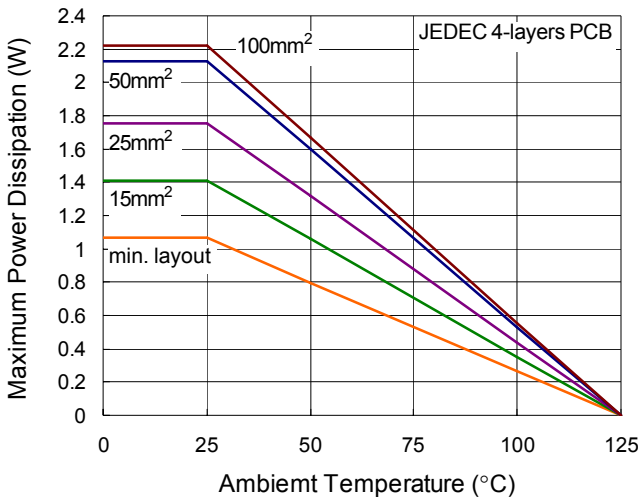
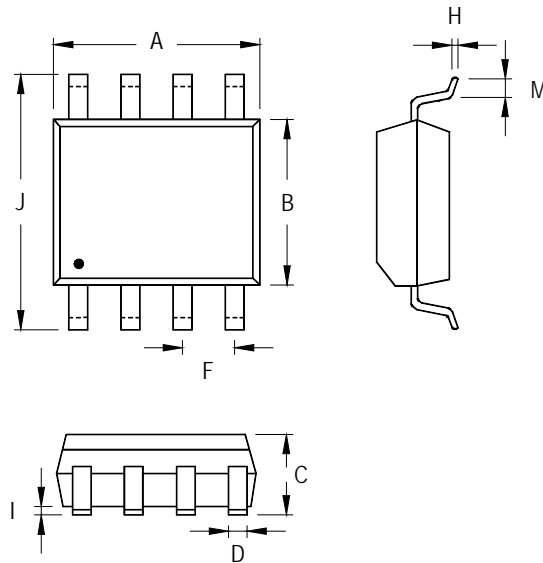

Figure 2. De-rating Curves for RT9027AB Package

Outline Dimension



Symbol	Dimensions In Millimeters		Dimensions In Inches	
	Min	Max	Min	Max
A	4.801	5.004	0.189	0.197
B	3.810	3.988	0.150	0.157
C	1.346	1.753	0.053	0.069
D	0.330	0.508	0.013	0.020
F	1.194	1.346	0.047	0.053
H	0.170	0.254	0.007	0.010
I	0.050	0.254	0.002	0.010
J	5.791	6.200	0.228	0.244
M	0.400	1.270	0.016	0.050

8-Lead SOP Plastic Package

Richtek Technology Corporation

Headquarter
 5F, No. 20, Taiyuen Street, Chupei City
 Hsinchu, Taiwan, R.O.C.
 Tel: (8863)5526789 Fax: (8863)5526611

Richtek Technology Corporation

Taipei Office (Marketing)
 5F, No. 95, Minchiuan Road, Hsintien City
 Taipei County, Taiwan, R.O.C.
 Tel: (8862)86672399 Fax: (8862)86672377
 Email: marketing@richtek.com

Information that is provided by Richtek Technology Corporation is believed to be accurate and reliable. Richtek reserves the right to make any change in circuit design, specification or other related things if necessary without notice at any time. No third party intellectual property infringement of the applications should be guaranteed by users when integrating Richtek products into any application. No legal responsibility for any said applications is assumed by Richtek.