

30170-V-MAG 340© Magnetic Universal Bracket - Single

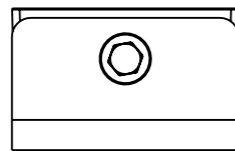
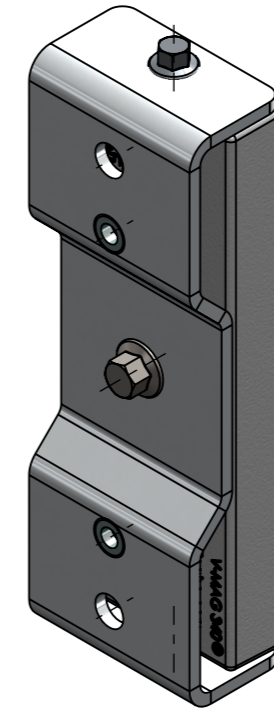
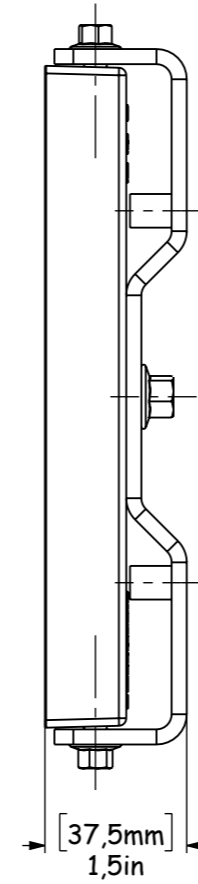
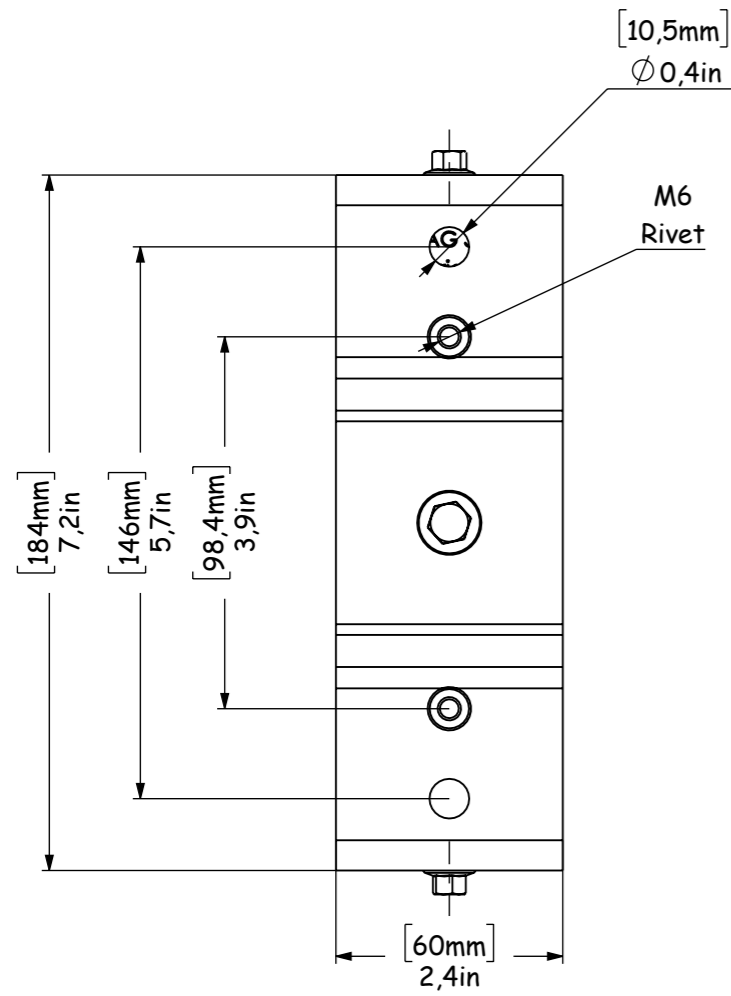

ENGISO[®]
ENGINEERED SOLUTIONS

Phone: (+45) 70 23 00 75
E-mail: info@Engiso.com

	Linear tolerance	0-10	10-50	50-500	500-1000	1000-
		± 0.1	± 0.2	± 0.5	± 0.8	± 1

Created: 29. januar 2020 Ini: ANO Updated: 9. november 2022 Ini: ANO

Surface treatment: _____ Approver: B.Ø.

Material: Material <not specified> Weight: 0.6 Kg

Material Cert. EN10204: _____ Item: **Fast Bracket V-MAG 340©**

Unit: Metric

A3	Sheet : 1 of 2	SCALE 1:2	Drawing no.: 30170-000-R1	Rev:
----	----------------	-----------	---------------------------	------

This drawing belongs Engiso, and may not be disclosed to third parties or used otherwise.

All sharp edges deburred.

30170-V-MAG 340© Magnetic Universal Bracket - Single

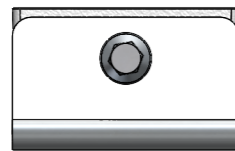
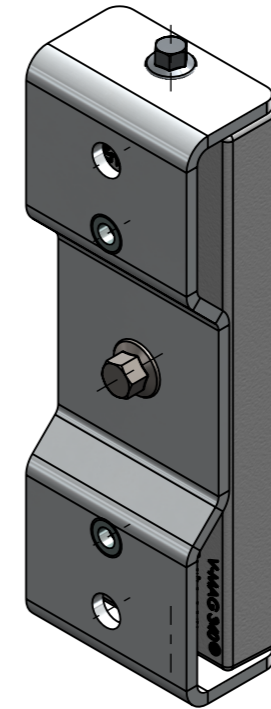
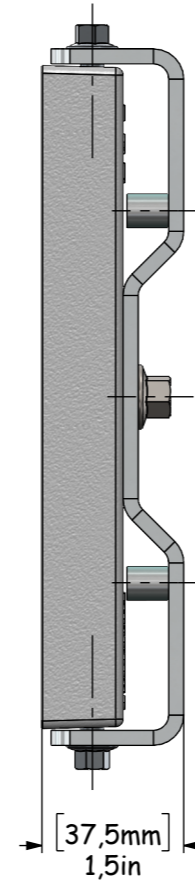
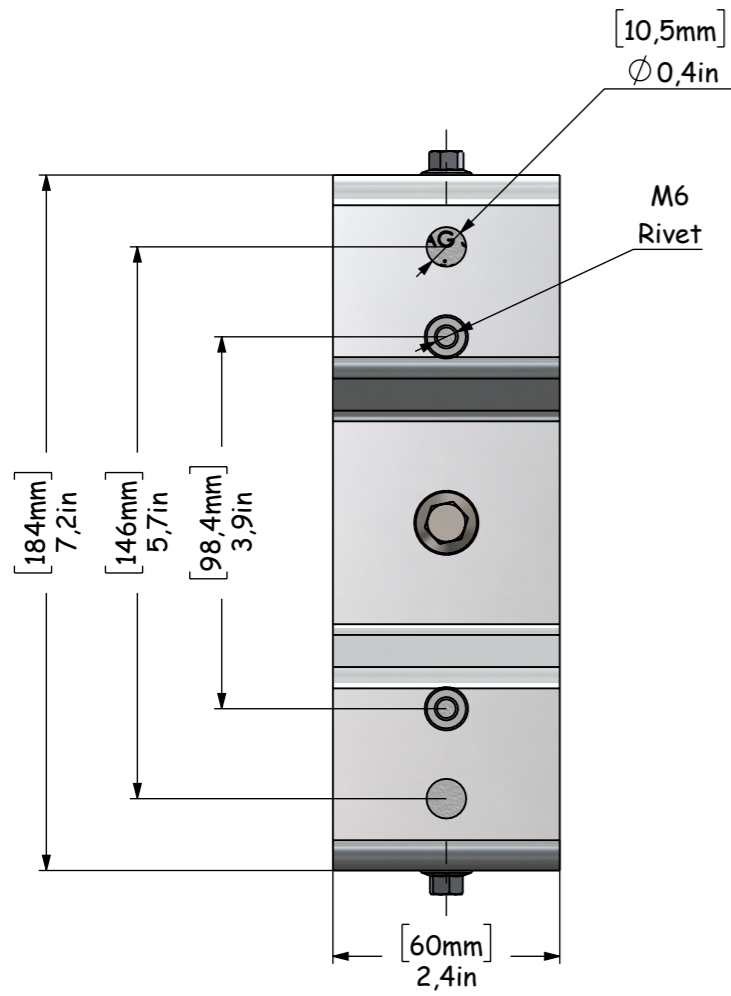



ENGISO[®]
ENGINEERED SOLUTIONS

Phone: (+45) 70 23 00 75
E-mail: info@Engiso.com

	Linear tolerance	0-10	10-50	50-500	500-1000	1000-
	± 0.1	± 0.2	± 0.5	± 0.8	± 1	± 1
Created: 29. januar 2020		Ini: ANO		Updated: 9. november 2022		Ini: ANO
Surface treatment:					Approver: B.Ø.	
Material: Material <not specified>			Weight: 0.6 Kg			
Material Cert. EN10204:			Item: Fast Bracket V-MAG 340©			
Unit: Metric						
A3	Sheet : 2 of 2	SCALE 1:2	Drawing no.: 30170-000-R1		Rev:	

This drawing belongs Engiso, and may not be disclosed to third parties or used otherwise.

All sharp edges deburred.