

ALC80E562KP250

Aliases (A547KW562M250E)

ALC80, Aluminum Electrolytic, 5,600 uF, 20%, 250 VDC, -40/+105°C

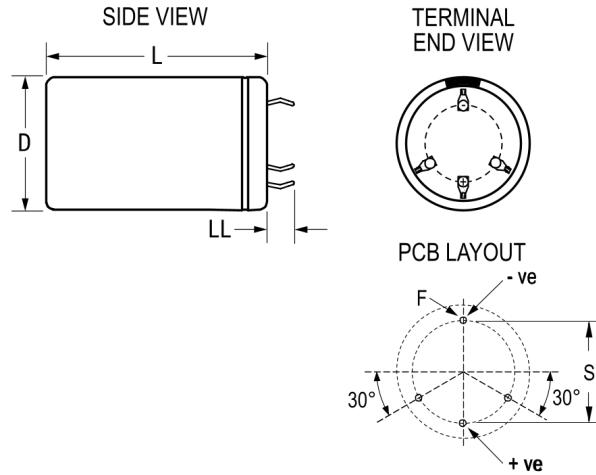

Click [here](#) for the 3D model.

Dimensions

D	50mm +1mm
L	105mm +/-2mm
S	22.5mm +/-0.1mm
LL	4mm +/-1mm
F	2mm +/-0.1mm

Packaging Specifications

Sleeving	Yes
Packaging	Bulk, Bag

General Information

Series	ALC80
Dielectric	Aluminum Electrolytic
Description	Snap-In, Aluminum Electrolytic
RoHS	Yes
Lead	4 Pin Short
AEC-Q200	No
Halogen Free	Yes
Component Weight	310 g
Notes	Dimensions D And L Include Sleeving.
Shelf Life	156 Weeks

Specifications

Capacitance	5,600 uF
Capacitance Tolerance	20%
Voltage DC	250 VDC, 288 VDC (Surge)
Temperature Range	-40/+105°C
Rated Temperature	105°C
Life	9000 Hrs (Rated Voltage and Ripple Current at 105C), 14000 Hrs (Rated Voltage at 105C)
Resistance	36.63 mOhms (100Hz 20C), 23.27 mOhms (10kHz 20C)
Ripple Current	10.4 Amps (100Hz 105C), 17.38 Amps (10kHz 105C)
Leakage Current	4200 uA (5min 20°C)