

## WINNIE-W

~50° wide beam. Holder with 35 mm screw hole distance according to Zhaga standard. Compatible with Bender+Wirth 4xx Typ L5 connector.

### SPECIFICATION:

Dimensions	Ø 49.8 mm
Height	19.3 mm
Fastening	screw
ROHS compliant	yes ⓘ



### MATERIALS:

Component	Type	Material	Colour	Finish
C14234_WINNIE-W	Single lens	PMMA	clear	
C14235_WINNIE-HOLDER	Holder	PC	white	

### ORDERING INFORMATION:

#### Quantities for one set:

Single lens	1
Holder	1

Component		Qty in box	MOQ	MPQ	Box weight (kg)
C14234_WINNIE-W	Single lens	364	84	28	5.6
» Box size: 480 x 280 x 300 mm					
C14235_WINNIE-HOLDER	Holder	1820	84	28	7.2
» Box size: 480 x 280 x 300 mm					

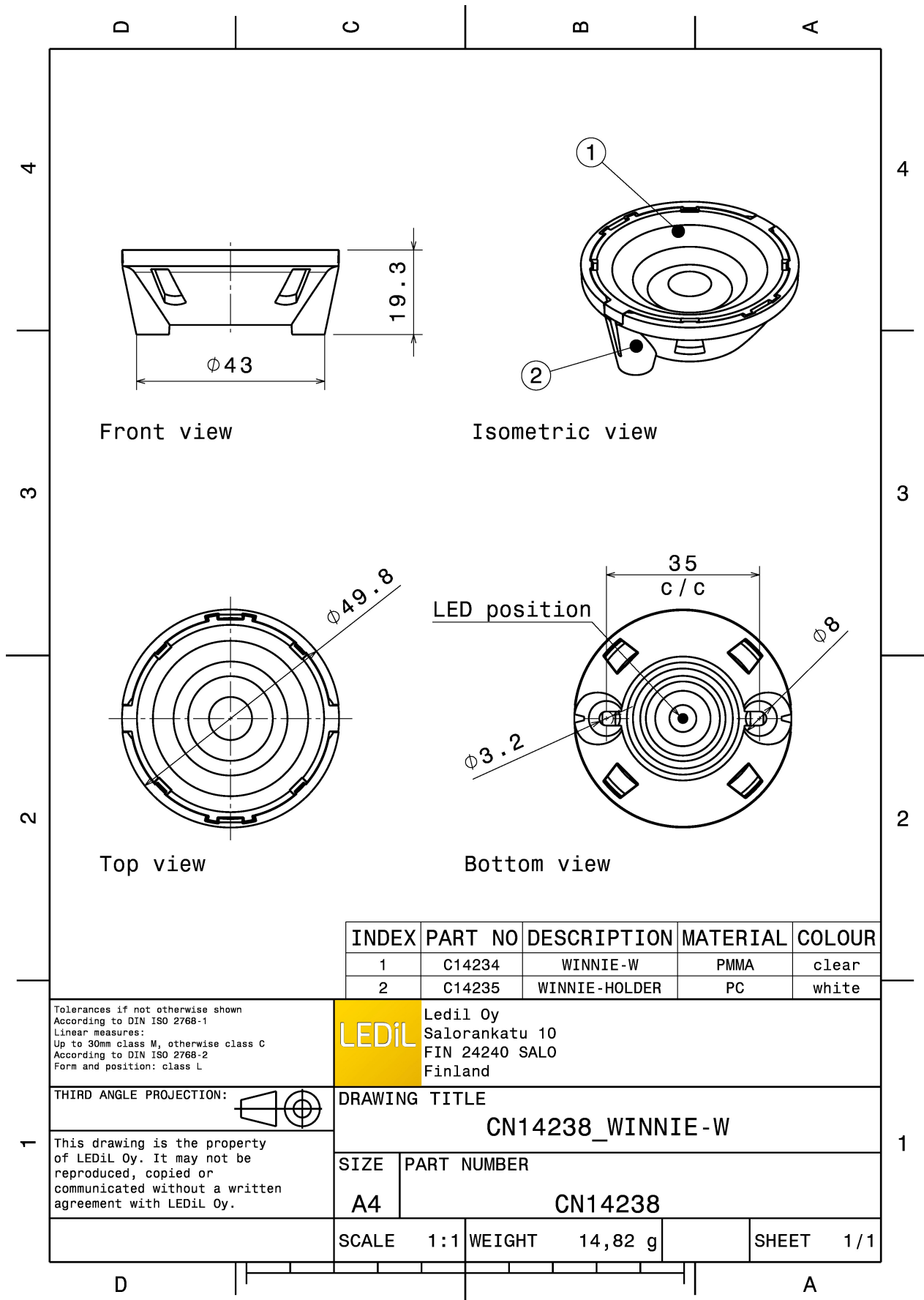

INDEX	PART NO	DESCRIPTION	MATERIAL	COLOUR
1	C14234	WINNIE-W	PMMA	clear
2	C14235	WINNIE-HOLDER	PC	white

Tolerances if not otherwise shown  
According to DIN ISO 2768-1  
Linear measures:  
Up to 30mm class M, otherwise class C  
According to DIN ISO 2768-2  
Form and position: class L

**LEDiL** Ledil Oy  
Salorankatu 10  
FIN 24240 SALO  
Finland

THIRD ANGLE PROJECTION:

DRAWING TITLE  
**CN14238\_WINNIE-W**









This drawing is the property of LEDiL Oy. It may not be reproduced, copied or communicated without a written agreement with LEDiL Oy.

SIZE	PART NUMBER
A4	CN14238

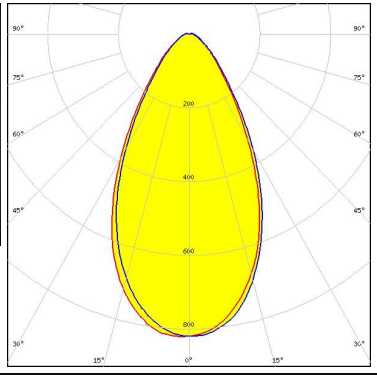
SCALE	1:1	WEIGHT	14,82 g	SHEET	1/1
-------	-----	--------	---------	-------	-----

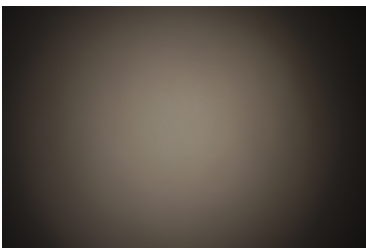
See also our general installation guide: [www.ledil.com/installation\\_guide](http://www.ledil.com/installation_guide)

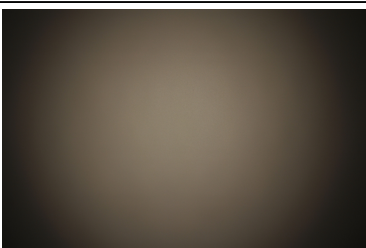
### OPTICAL RESULTS (MEASURED):

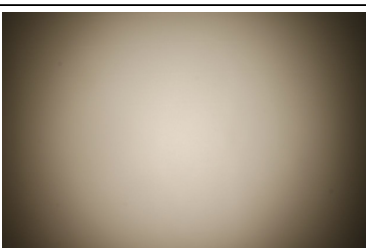
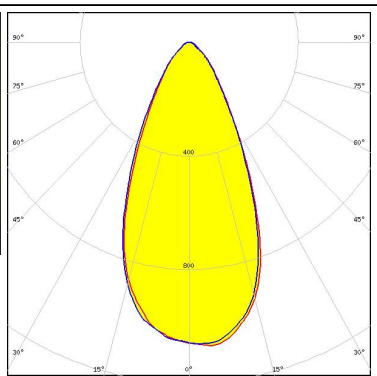
<p></p> <p>LED V18 Gen6            FWHM / FWTM 56.0° / 102.0°            Efficiency 88 %            Peak intensity 0.8 cd/lm            LEDs/each optic 1            Light colour White            Required components:</p>		
<p></p> <p>LED V6 Gen6            FWHM / FWTM 47.0° / 92.0°            Efficiency 87 %            Peak intensity 1.2 cd/lm            LEDs/each optic 1            Light colour White            Required components:</p>		
<p></p> <p>LED V8 Gen6            FWHM / FWTM 48.0° / 92.0°            Efficiency 88 %            Peak intensity 1.1 cd/lm            LEDs/each optic 1            Light colour White            Required components:</p>		
<p></p> <p>LED VERO10            FWHM / FWTM 49.0° / 90.0°            Efficiency 90 %            Peak intensity 1.1 cd/lm            LEDs/each optic 1            Light colour White            Required components:</p>		

### OPTICAL RESULTS (MEASURED):

#### CITIZEN

LED CLL01x  
 FWHM / FWTM 45.0° / 90.0°  
 Efficiency 87 %  
 Peak intensity 1.2 cd/lm  
 LEDs/each optic 1  
 Light colour White  
 Required components:

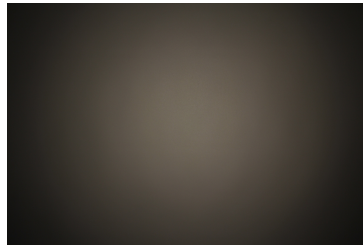

#### CITIZEN

LED CLL02x/CLU02x (LES10)  
 FWHM / FWTM 46.0° / 90.0°  
 Efficiency 87 %  
 Peak intensity 1.6 cd/lm  
 LEDs/each optic 1  
 Light colour White  
 Required components:

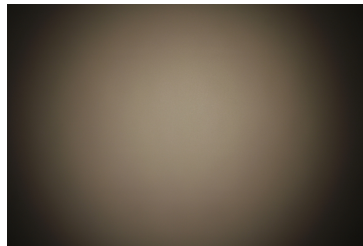

#### CITIZEN

LED CLL02x/CLU02x (LES10)  
 FWHM / FWTM 46.0° / 88.0°  
 Efficiency 87 %  
 Peak intensity 1.1 cd/lm  
 LEDs/each optic 1  
 Light colour White  
 Required components:  
 Bender Wirth: 434 Typ L5

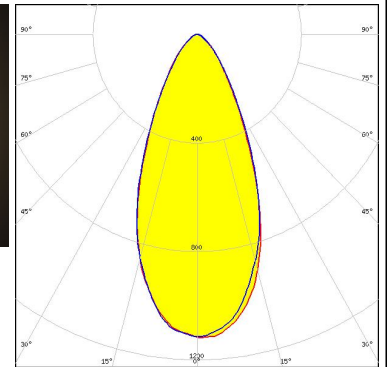
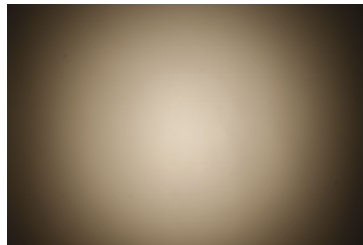

#### CITIZEN

LED CLL03x/CLU03x  
 FWHM / FWTM 48.0° / 91.0°  
 Efficiency 88 %  
 Peak intensity 1 cd/lm  
 LEDs/each optic 1  
 Light colour White  
 Required components:  
 Bender Wirth: 433 Typ L5

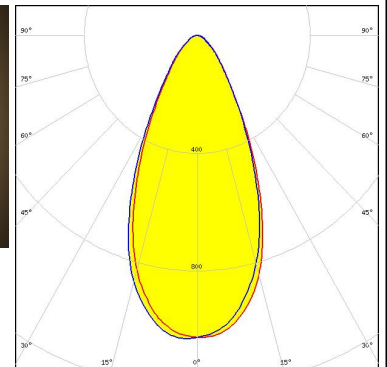
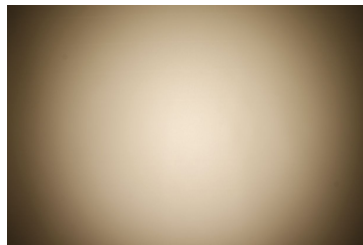

### OPTICAL RESULTS (MEASURED):

#### CITIZEN

LED CLU700/701/702/703  
 FWHM / FWTM 42.0° / 83.0°  
 Efficiency 88 %  
 Peak intensity 1.3 cd/lm  
 LEDs/each optic 1  
 Light colour White  
 Required components:

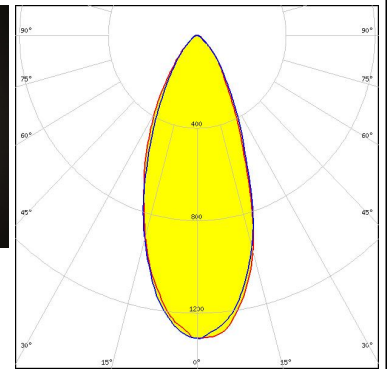
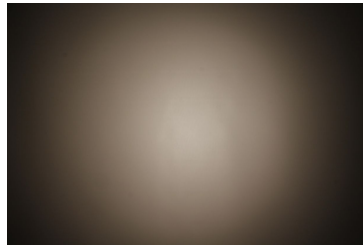

#### CITIZEN

LED CLU700/701/702/703  
 FWHM / FWTM 42.0° / 84.0°  
 Efficiency 88 %  
 Peak intensity 1.3 cd/lm  
 LEDs/each optic 1  
 Light colour White  
 Required components:  
 Bender Wirth: 434 Typ L5

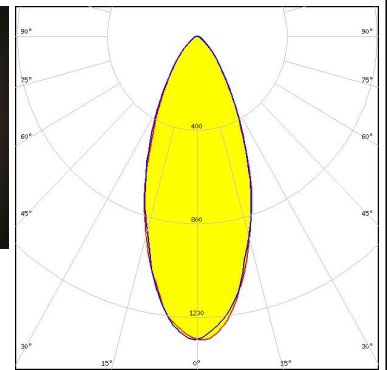
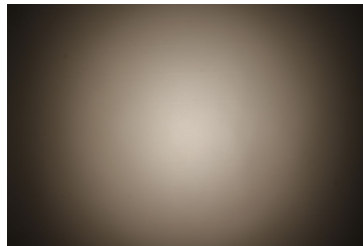

#### CITIZEN

LED CLU710/711  
 FWHM / FWTM 45.0° / 86.0°  
 Efficiency 88 %  
 Peak intensity 1.2 cd/lm  
 LEDs/each optic 1  
 Light colour White  
 Required components:  
 Bender Wirth: 470 Typ L5

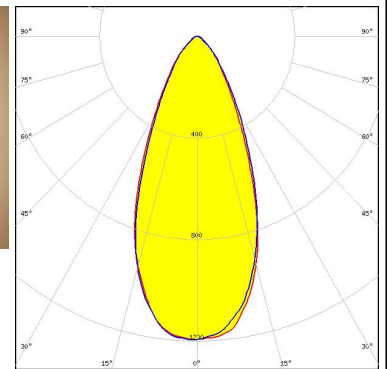
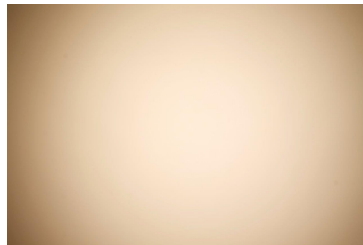

#### CITIZEN

LED CLU710/711  
 FWHM / FWTM 47.0° / 93.0°  
 Efficiency 87 %  
 Peak intensity 1 cd/lm  
 LEDs/each optic 1  
 Light colour White  
 Required components:

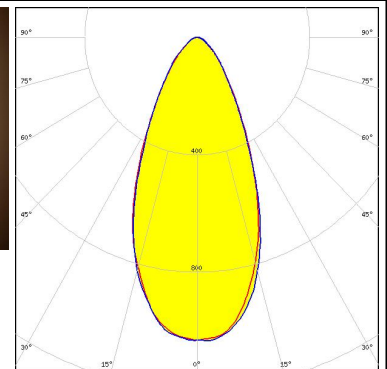
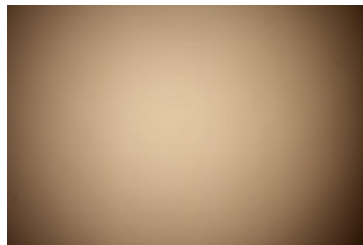

### OPTICAL RESULTS (MEASURED):

#### CITIZEN

LED CLU720/721/723  
 FWHM / FWTM 45.0° / 85.0°  
 Efficiency 87 %  
 Peak intensity 1.2 cd/lm  
 LEDs/each optic 1  
 Light colour White  
 Required components:  
 Bender Wirth: 433 Typ L5

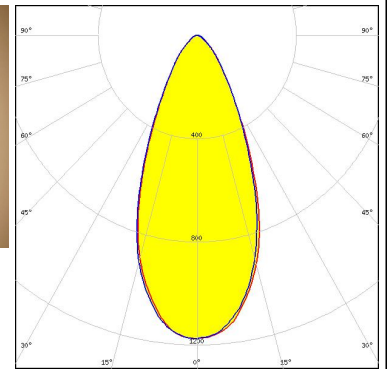
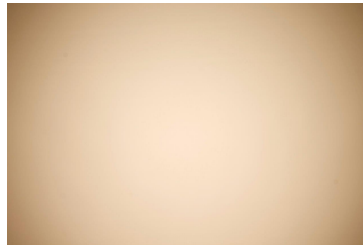

#### CREE LED

LED CXA/B 13xx  
 FWHM / FWTM 51.0° / 96.0°  
 Efficiency 89 %  
 Peak intensity 1.1 cd/lm  
 LEDs/each optic 1  
 Light colour White  
 Required components:

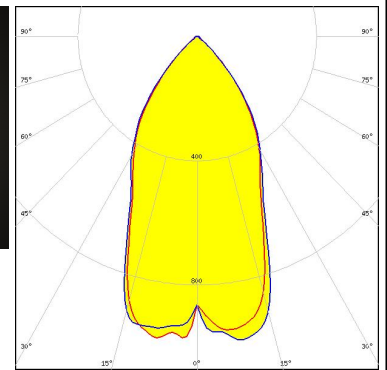
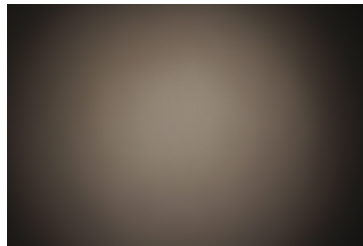

#### CREE LED

LED CXA/B 15xx  
 FWHM / FWTM 52.0° / 96.0°  
 Efficiency 87 %  
 Peak intensity 1.1 cd/lm  
 LEDs/each optic 1  
 Light colour White  
 Required components:

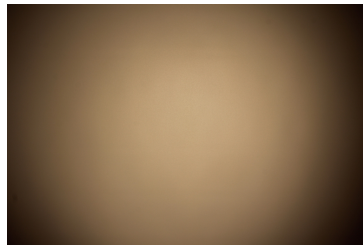

#### CREE LED

LED MHD-E/G  
 FWHM / FWTM 45.0° / 91.0°  
 Efficiency 88 %  
 Peak intensity 1.1 cd/lm  
 LEDs/each optic 1  
 Light colour White  
 Required components:

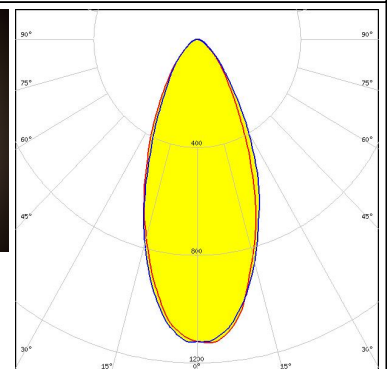
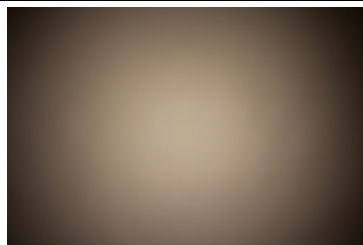

### OPTICAL RESULTS (MEASURED):

#### LUMILEDS

LED LUXEON CoB 1202/1203  
FWHM / FWTM 48.0° / 94.0°  
Efficiency 88 %  
Peak intensity 1.1 cd/lm  
LEDs/each optic 1  
Light colour White  
Required components:

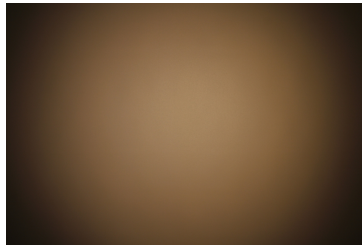

#### LUMILEDS

LED LUXEON CoB 1202s  
FWHM / FWTM 46.0° / 90.0°  
Efficiency 89 %  
Peak intensity 1.3 cd/lm  
LEDs/each optic 1  
Light colour White  
Required components:

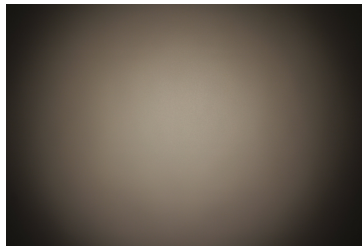

#### LUMINUS

LED CxM-14 (19x19)  
FWHM / FWTM 50.0° / 96.0°  
Efficiency 86 %  
Peak intensity 1 cd/lm  
LEDs/each optic 1  
Light colour White  
Required components:

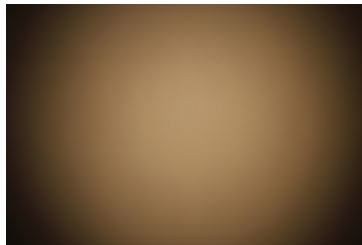

#### LUMINUS

LED CxM-9 (13.5x13.5)  
FWHM / FWTM 48.0° / 92.0°  
Efficiency 90 %  
Peak intensity 1.3 cd/lm  
LEDs/each optic 1  
Light colour White  
Required components:

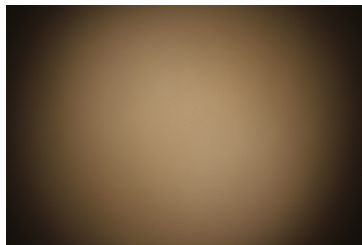



### OPTICAL RESULTS (MEASURED):

#### OSRAM

Opto Semiconductors

LED Duris S10  
 FWHM / FWTM 54.0° / 90.0°  
 Efficiency 88 %  
 Peak intensity 1 cd/lm  
 LEDs/each optic 1  
 Light colour White  
 Required components:

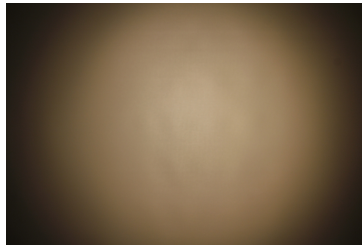

#### OSRAM

Opto Semiconductors

LED Soleriq S13  
 FWHM / FWTM 49.0° / 92.0°  
 Efficiency 87 %  
 Peak intensity 1 cd/lm  
 LEDs/each optic 1  
 Light colour White  
 Required components:

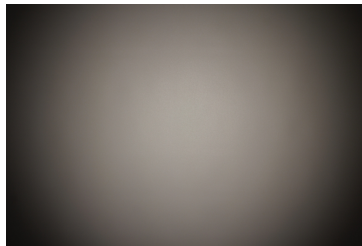

#### OSRAM

Opto Semiconductors

LED Soleriq S19  
 FWHM / FWTM 50.0° / 94.0°  
 Efficiency 84 %  
 Peak intensity 1 cd/lm  
 LEDs/each optic 1  
 Light colour White  
 Required components:

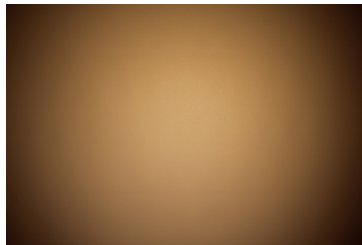

#### SAMSUNG

LED LC003D / LC006D / LC009D / LC013D  
 FWHM / FWTM 47.0° / 89.0°  
 Efficiency 88 %  
 Peak intensity 1.1 cd/lm  
 LEDs/each optic 1  
 Light colour White  
 Required components:

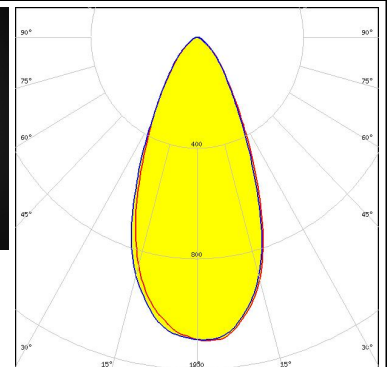
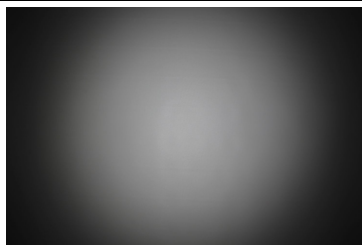

### OPTICAL RESULTS (MEASURED):

#### SAMSUNG

LED LC016D / LC019D / LC026D / LC033D  
 FWHM / FWTM 52.0° / 96.0°  
 Efficiency 85 %  
 Peak intensity 0.9 cd/m  
 LEDs/each optic 1  
 Light colour White  
 Required components:

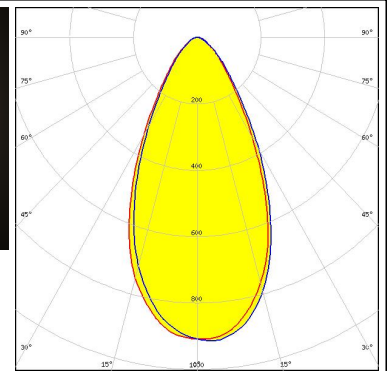
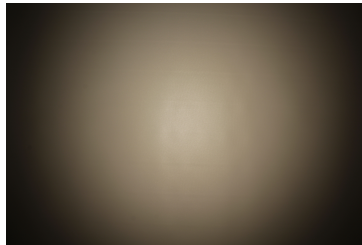

**SEOUL SEMICONDUCTOR**  
 LED MJT COB LES 14.5  
 FWHM / FWTM 51.0° / 96.0°  
 Efficiency 84 %  
 Peak intensity 0.9 cd/m  
 LEDs/each optic 1  
 Light colour White  
 Required components:  
 Bender Wirth: 433 Typ L5

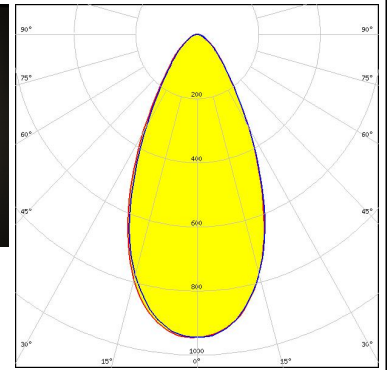
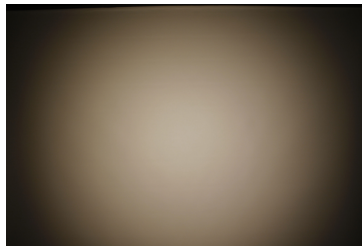

**SEOUL SEMICONDUCTOR**  
 LED MJT COB LES 9.8  
 FWHM / FWTM 46.0° / 88.0°  
 Efficiency 90 %  
 Peak intensity 1.1 cd/m  
 LEDs/each optic 1  
 Light colour White  
 Required components:  
 Bender Wirth: 434 Typ L5

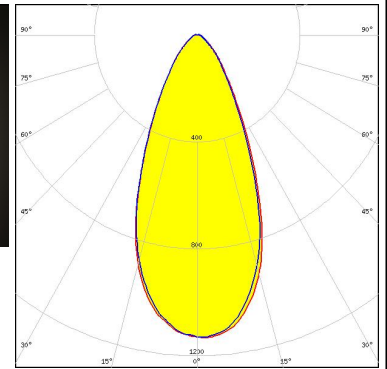
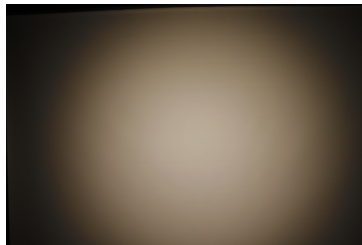

**SEOUL SEMICONDUCTOR**  
 LED ZC12/18  
 FWHM / FWTM 48.0° / 90.0°  
 Efficiency 89 %  
 Peak intensity 1.1 cd/m  
 LEDs/each optic 1  
 Light colour White  
 Required components:  
 Bender Wirth: 433 Typ L5

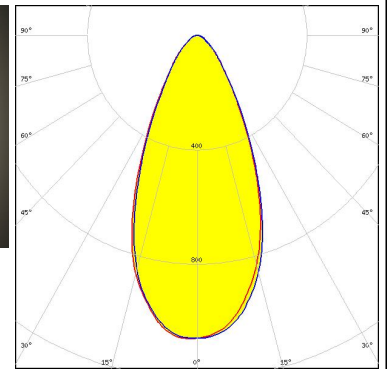
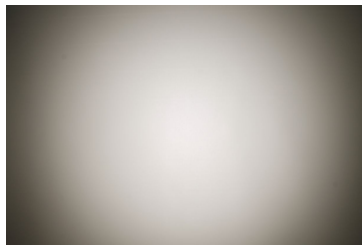

### OPTICAL RESULTS (MEASURED):

**VS LIGHTING SOLUTIONS**

LED DMC 124 / 125  
 FWHM / FWTM 45.0° / 84.0°  
 Efficiency 89 %  
 Peak intensity 1.2 cd/lm  
 LEDs/each optic 1  
 Light colour White  
 Required components:  
 Bender Wirth: 433 Typ L5

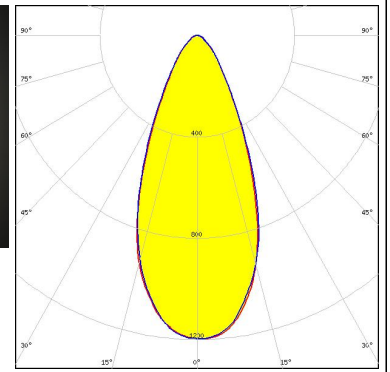
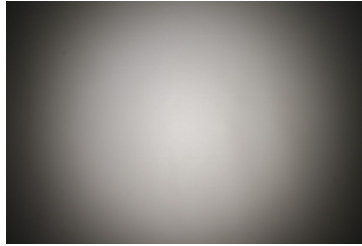

**VS LIGHTING SOLUTIONS**

LED DMC 128  
 FWHM / FWTM 49.0° / 90.0°  
 Efficiency 88 %  
 Peak intensity 1 cd/lm  
 LEDs/each optic 1  
 Light colour White  
 Required components:  
 Bender Wirth: 433 Typ L5

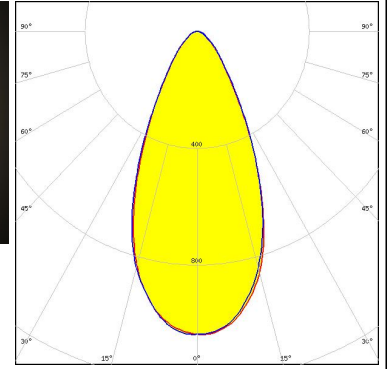
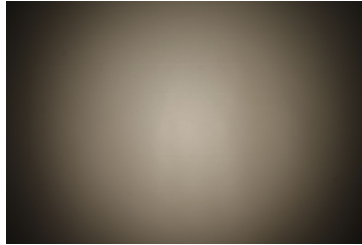

### OPTICAL RESULTS (SIMULATED):



LED CXA/B 15xx  
 FWHM / FWTM 48.0° / 88.0°  
 Efficiency 86 %  
 Peak intensity 1.1 cd/lm  
 LEDs/each optic 1  
 Light colour White  
 Required components:  
 C14305\_STELLA-CLAMP-CXA15-18

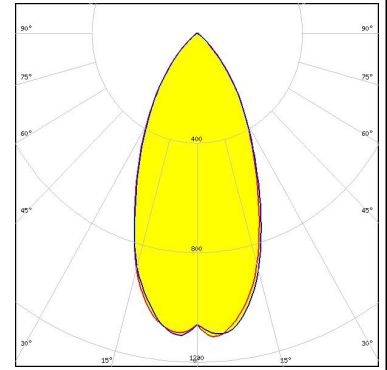

LED LUXEON CoB 1202/1203  
 FWHM / FWTM 47.0° / 88.0°  
 Efficiency 89 %  
 Peak intensity 1.2 cd/lm  
 LEDs/each optic 1  
 Light colour White  
 Required components:  
 Bender Wirth: 441 Typ L5

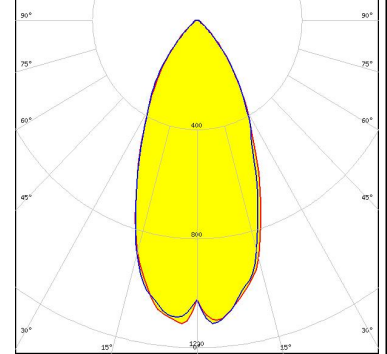

LED LUXEON CoB Compact  
 FWHM / FWTM 46.0° / 90.0°  
 Efficiency 89 %  
 Peak intensity 1.3 cd/lm  
 LEDs/each optic 1  
 Light colour White  
 Required components:



LED LUXEON M/MX  
 FWHM / FWTM 56.0° / 98.0°  
 Efficiency 94 %  
 Peak intensity 0.9 cd/lm  
 LEDs/each optic 1  
 Light colour White  
 Required components:

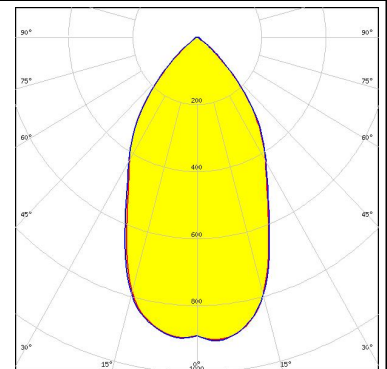

### OPTICAL RESULTS (SIMULATED):



**LED** CxM-14 (19x19)  
**FWHM / FWTM** 48.0° / 91.0°  
**Efficiency** 88 %  
**Peak intensity** 1 cd/lm  
**LEDs/each optic** 1  
**Light colour** White  
**Required components:**  
 Bender Wirth: 433 Typ L5



**LED** CxM-9 (13.5x13.5)  
**FWHM / FWTM** 46.0° / 88.0°  
**Efficiency** 87 %  
**Peak intensity** 1.1 cd/lm  
**LEDs/each optic** 1  
**Light colour** White  
**Required components:**  
 Bender Wirth: 434 Typ L5



**LED** COB S-Type (LES 6)  
**FWHM / FWTM** 44.0° / 90.0°  
**Efficiency** 92 %  
**Peak intensity** 1.2 cd/lm  
**LEDs/each optic** 1  
**Light colour** White  
**Required components:**

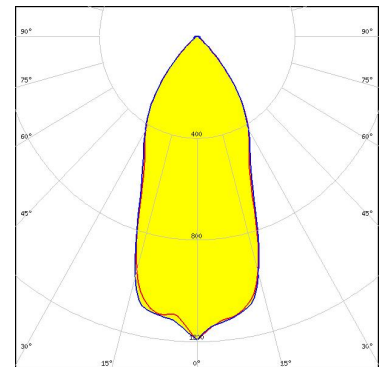

**LED** Soleriq S9  
**FWHM / FWTM** 45.0° / 87.0°  
**Efficiency** 90 %  
**Peak intensity** 1.2 cd/lm  
**LEDs/each optic** 1  
**Light colour** White  
**Required components:**

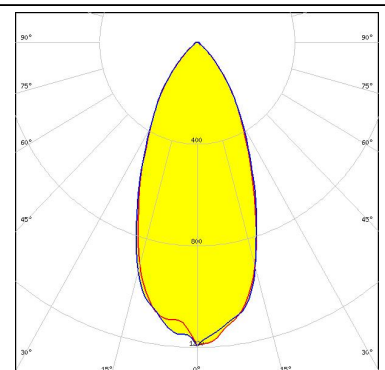

### OPTICAL RESULTS (SIMULATED):

#### SAMSUNG

LED LC010C  
 FWHM / FWTM 45.0° / 88.0°  
 Efficiency 91 %  
 Peak intensity 1.2 cd/lm  
 LEDs/each optic 1  
 Light colour White  
 Required components:  
 Bender Wirth: 479 Typ L5

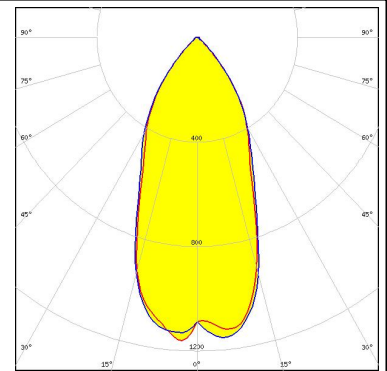

#### SAMSUNG

LED LC020C  
 FWHM / FWTM 45.0° / 86.0°  
 Efficiency 89 %  
 Peak intensity 1.2 cd/lm  
 LEDs/each optic 1  
 Light colour White  
 Required components:  
 Bender Wirth: 479 Typ L5

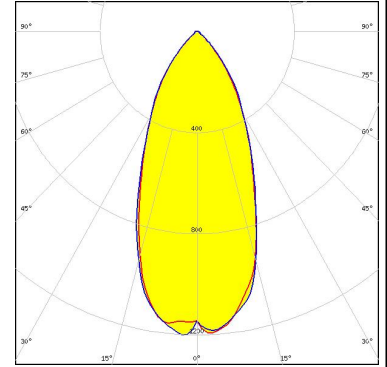

#### SAMSUNG

LED LC040C  
 FWHM / FWTM 45.0° / 86.0°  
 Efficiency 88 %  
 Peak intensity 1.2 cd/lm  
 LEDs/each optic 1  
 Light colour White  
 Required components:  
 Bender Wirth: 479 Typ L5

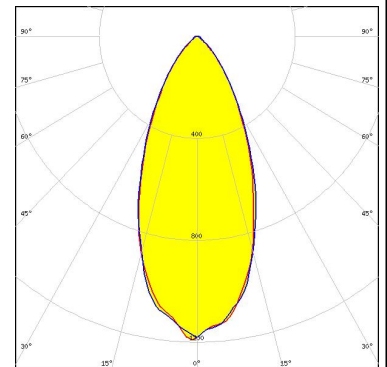

SEOUL SEMICONDUCTOR

LED ZC4/6  
 FWHM / FWTM 46.0° / 88.0°  
 Efficiency 87 %  
 Peak intensity 1.1 cd/lm  
 LEDs/each optic 1  
 Light colour White  
 Required components:  
 Bender Wirth: 434 Typ L5

### GENERAL INFORMATION:

NOTE: The typical beam angle will be changed by different color, chip size and chip position tolerance. The typical total beam angle is the full angle measured where the luminous intensity is half of the peak value.

Due to use of high power COB's with this product, special attention to proper thermal design is highly recommended. LEDiL has no liability for direct, indirect or consecutive damages arising from the LEDiL products being used outside of the recommended temperature range.

### MATERIALS:

As part of our continuous research and improvement processes, and to ensure the best possible quality and availability of our products, LEDiL reserves the right to change material grades without notice.

### PRODUCT DATA USER AGREEMENT AND DISCLAIMER:

The measured data in the provided downloadable LEDiL Product Datasheets and Mechanical 2D-Drawings is rounded and provided as reference for planning. LEDiL Oy's optical specifications have been verified by conducting performance testing of the products in accordance with the company's quality system. The reported data are averaged results of multiple measurements with typical variation. LEDiL Oy reserves the right to without prior notification make changes and improvements to its products.

LEDiL Oy assumes neither warranty, nor guarantee nor any other liability of any kind for the contents and correctness of the provided data. The provided data has been generated with highest diligence but the provided data may in reality not represent the complete possible variation range of all intrinsic parameters. Therefore, in certain cases a deviation from the provided data could occur.

LEDiL Oy reserves the right to undertake technical changes of its products without further notification which could lead to changes in the provided data. LEDiL Oy assumes no liability of any kind for the possible deviation from any provided data or any other damage resulting from the usage of the provided data.

The user agrees to this disclaimer and user agreement with the download or usage of the provided files.

#### LEDiL Oy

Joensuunkatu 13  
FI-24240 SALO  
Finland

#### LEDiL Inc.

228 West Page Street  
Suite D  
Sycamore IL 60178  
USA

#### Ledil Optics Technology (Shenzhen) Co., Ltd.

# 405 , Block B  
Casic Motor Building  
Shenzhen 518057  
P.R.CHINA

#### Local sales and technical support

[www.ledil.com/  
where\\_to\\_buy](http://www.ledil.com/where_to_buy)

#### Shipping locations

Salo, Finland  
Hong Kong, China

#### Distribution Partners

[www.ledil.com/  
where\\_to\\_buy](http://www.ledil.com/where_to_buy)