

1

2

3

4

A

A

B

B

C

C

D

D

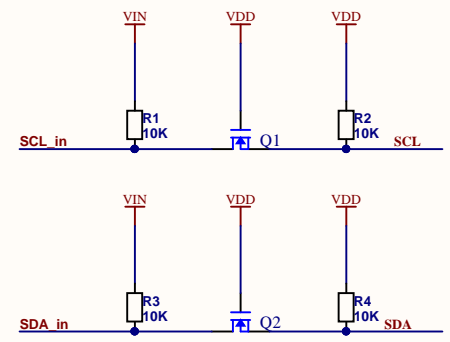
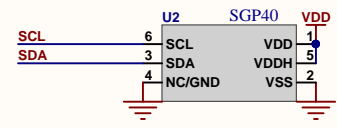
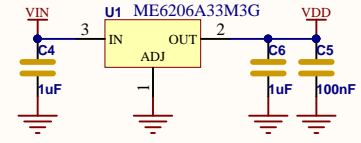
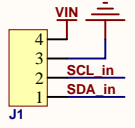

Title: DFRobot SGP40 Air Quality Sensor	Code: SEN0392
Drawn: lfwag-CD	Revision: V1.0
Page: 1 of 1	Date: 2021/11/11
Size: A4	Time: 10:49:10

1

2

3

4

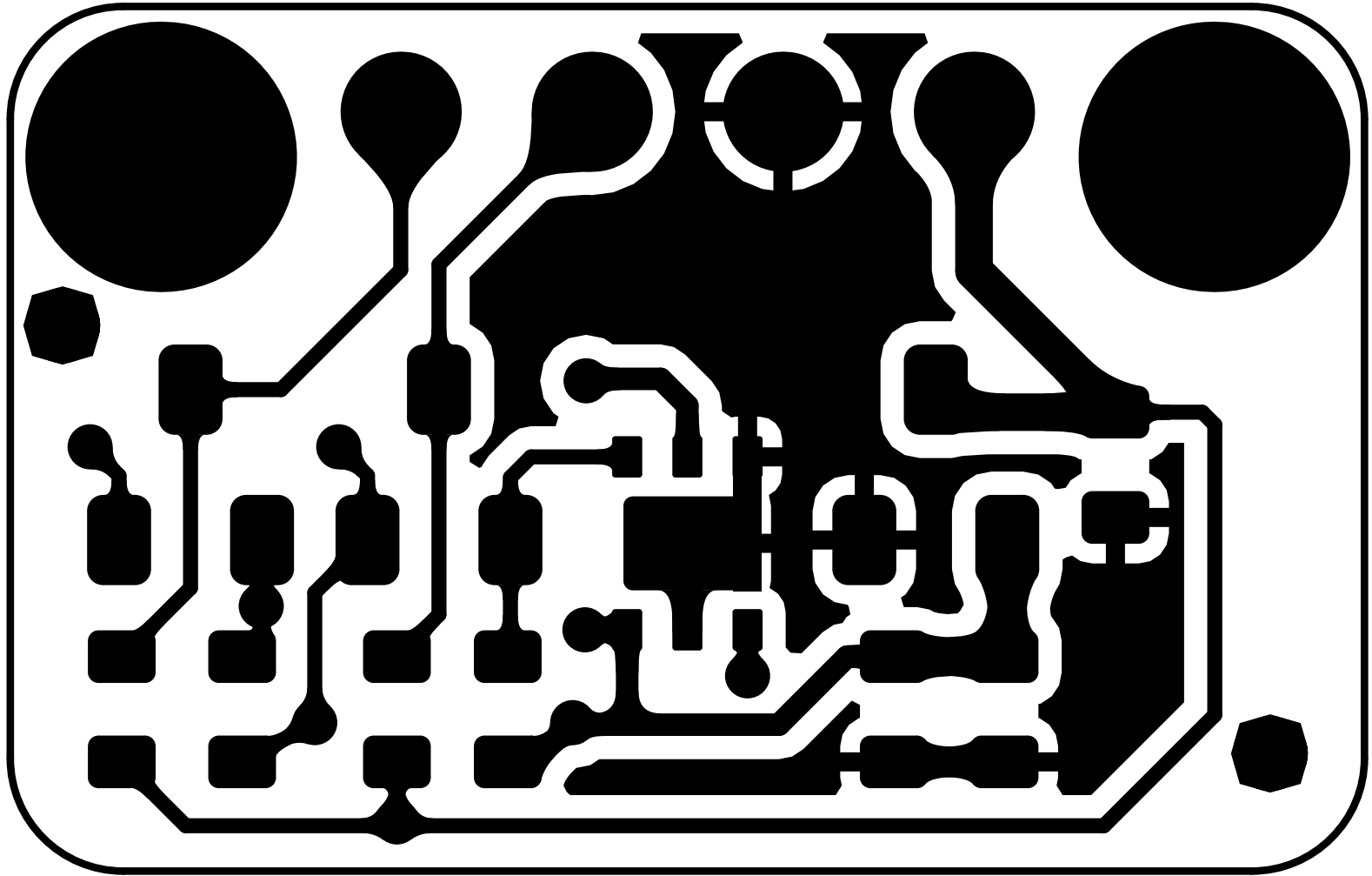

PCB Information	Name:SEN0392[V1.0]	Thickness: 1.0mm
Engineer:lfwag_CD	Top SolderMask: Black	Bottom SolderMask: Black
Date: 20210111	Top Silkscreen: White	Bottom Silkscreen: White

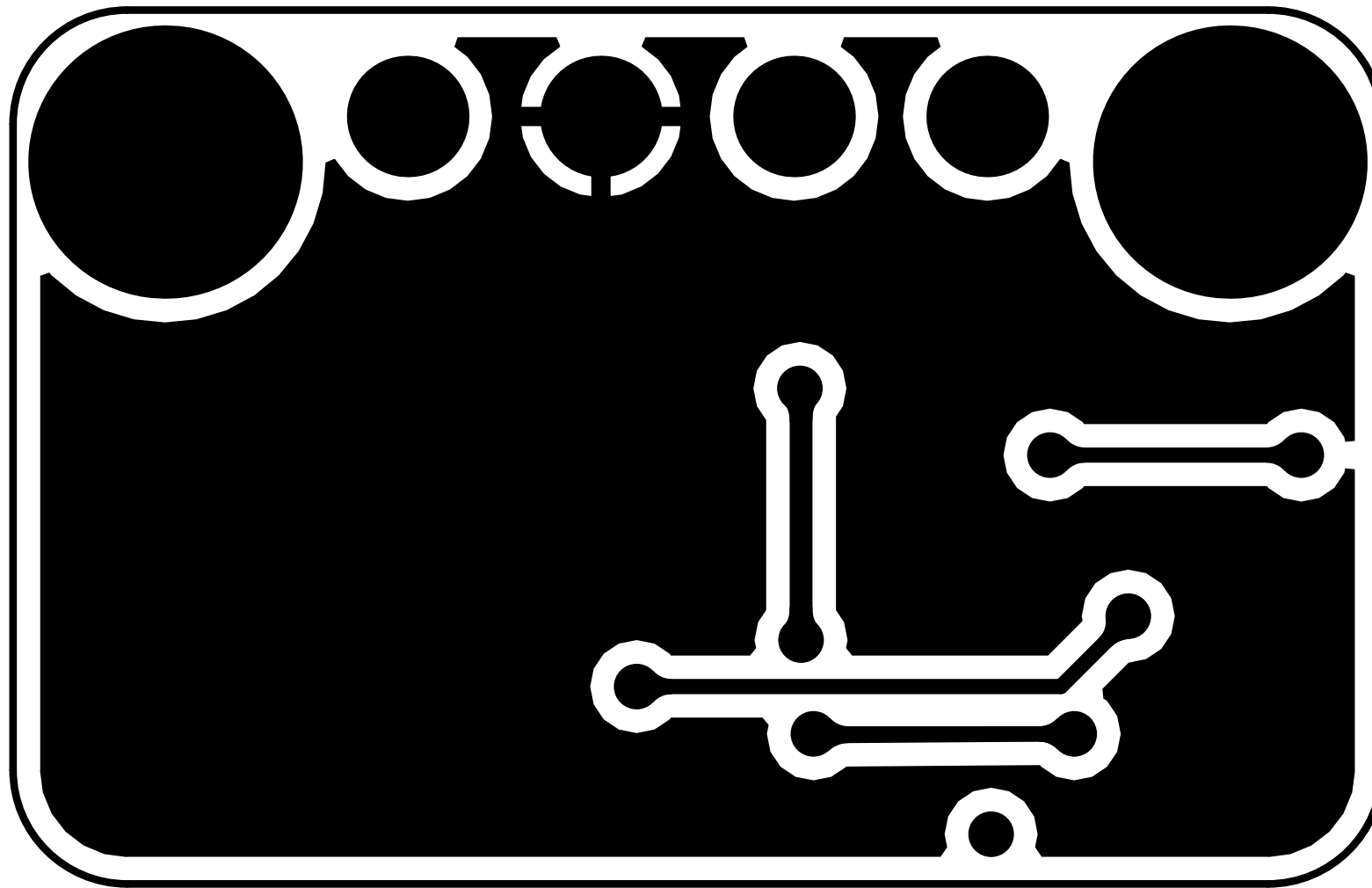

PCB Information	Name:SEN0392[V1.0]	Thickness: 1.0mm
Engineer:lfwag_CD	Top SolderMask: Black	Bottom SolderMask: Black
Date: 20210111	Top Silkscreen: White	Bottom Silkscreen: White

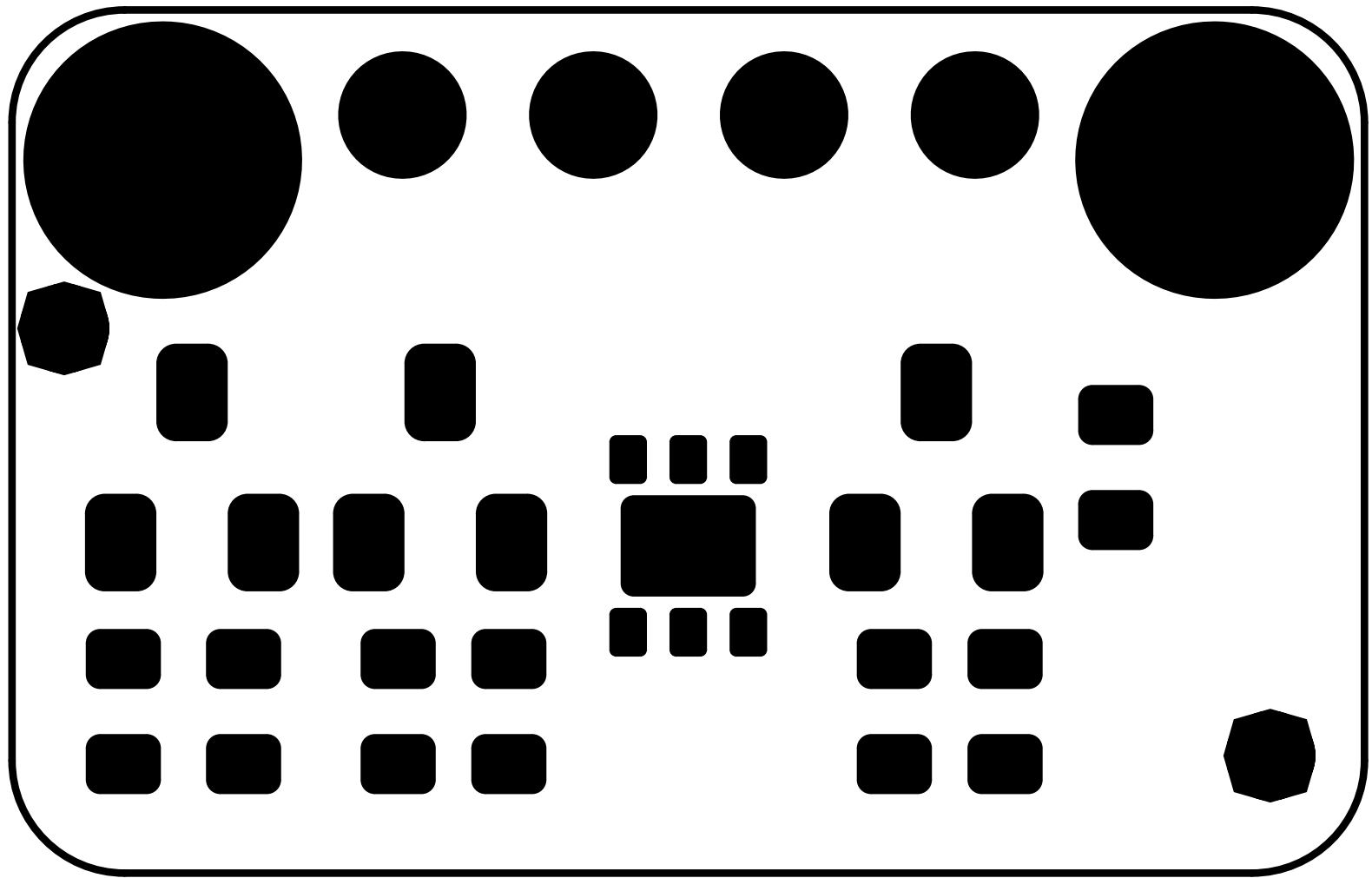

PCB Information	Name:SEN0392[V1.0]	Thickness: 1.0mm
Engineer:lfwag_CD	Top SolderMask: Black	Bottom SolderMask: Black
Date: 20210111	Top Silkscreen: White	Bottom Silkscreen: White

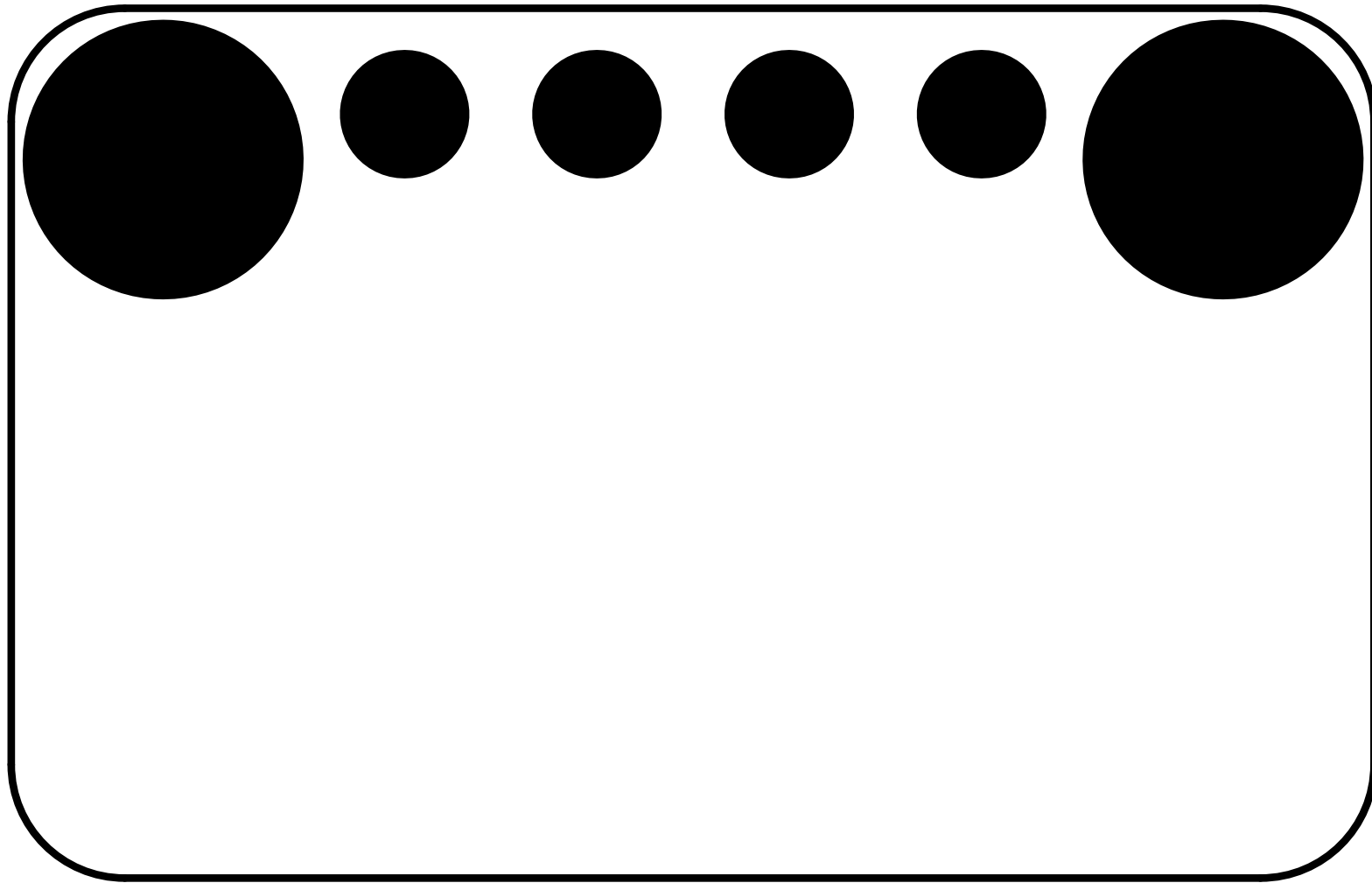

PCB Information	Name:SEN0392[V1.0]	Thickness: 1.0mm
Engineer:lfwag_CD	Top SolderMask: Black	Bottom SolderMask: Black
Date: 20210111	Top Silkscreen: White	Bottom Silkscreen: White

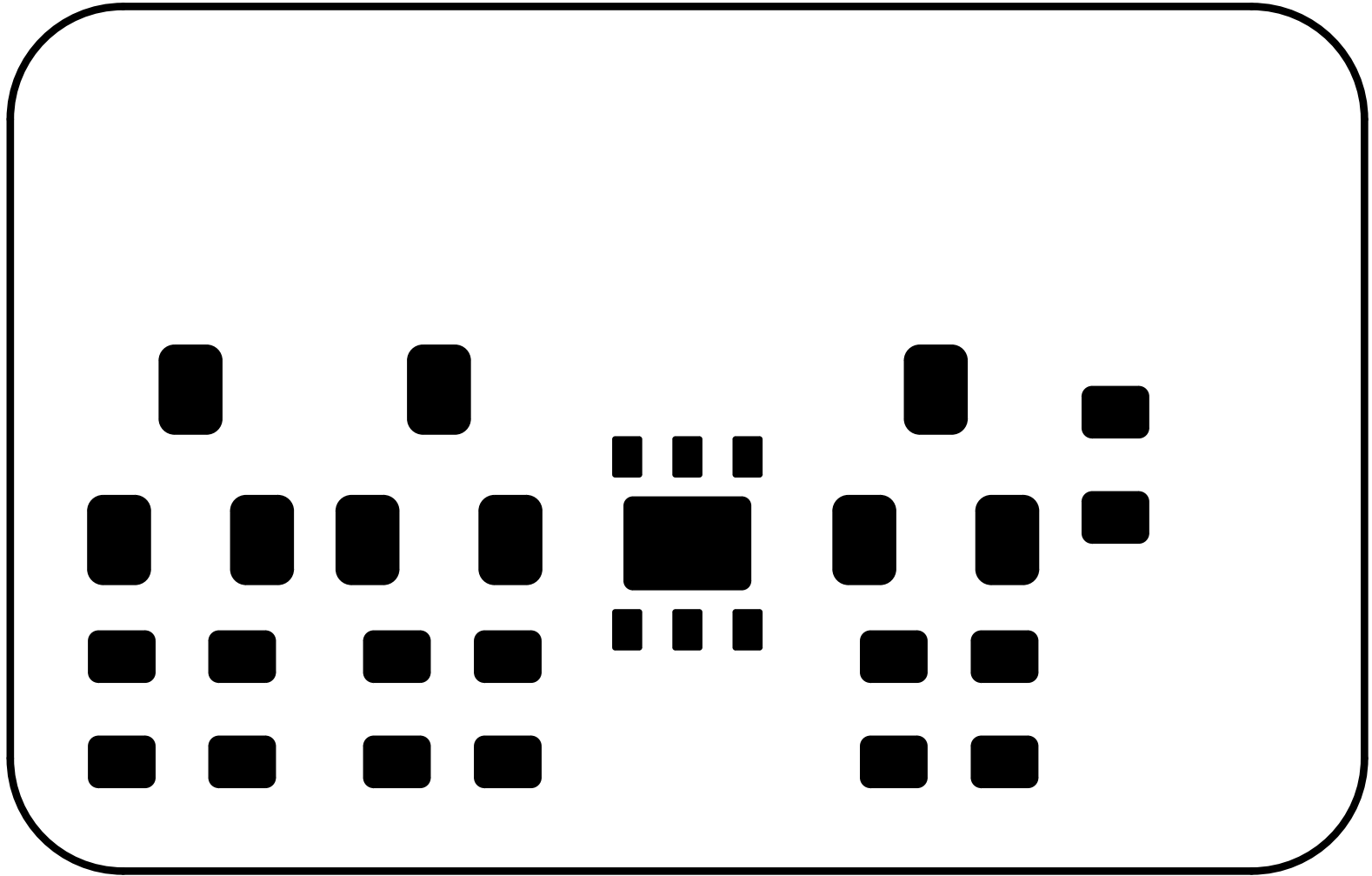

PCB Information	Name:SEN0392[V1.0]	Thickness: 1.0mm
Engineer:lfwag_CD	Top SolderMask: Black	Bottom SolderMask: Black
Date: 20210111	Top Silkscreen: White	Bottom Silkscreen: White

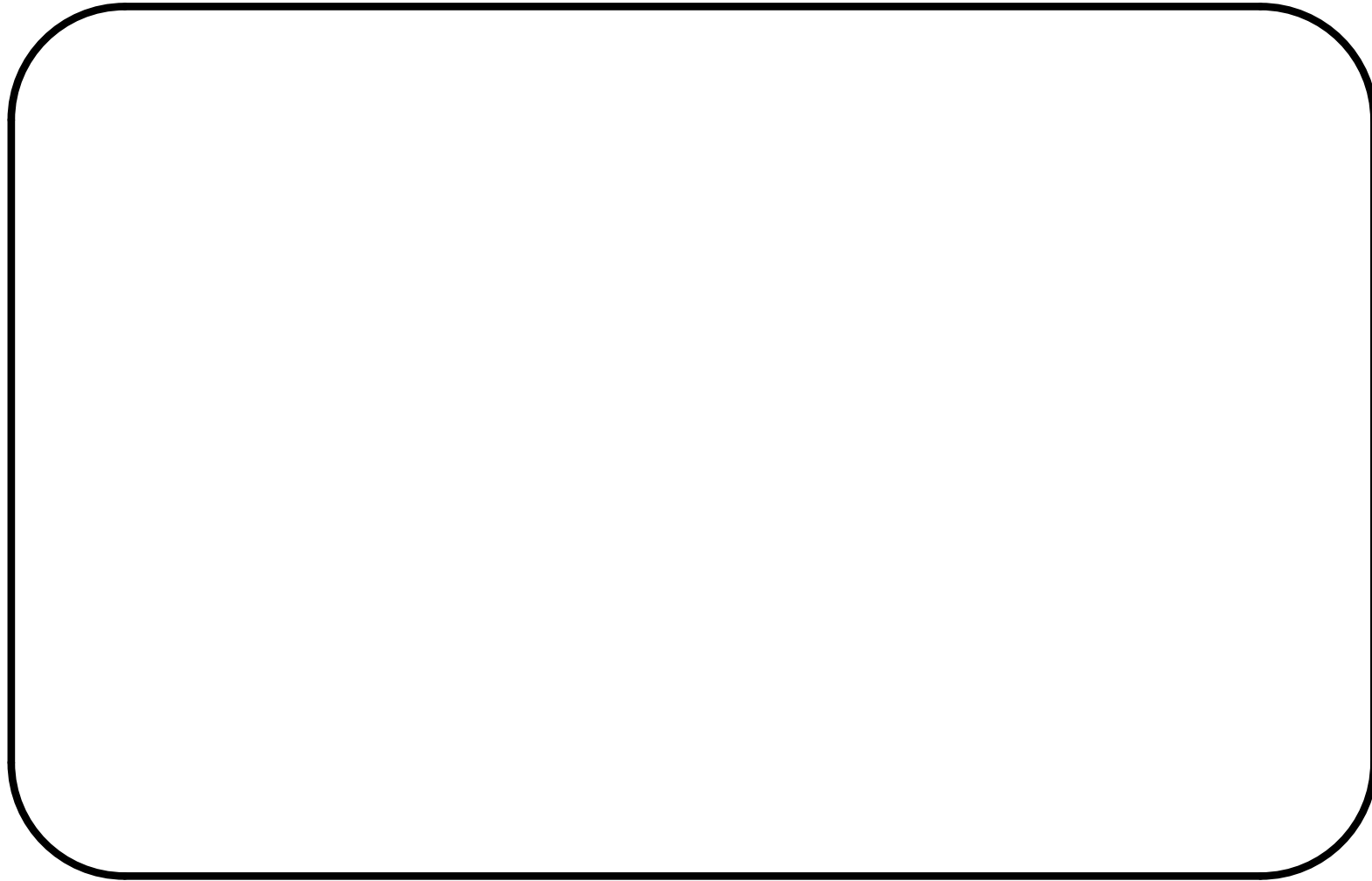

PCB Information	Name:SEN0392[V1.0]	Thickness: 1.0mm
Engineer:lfwag_CD	Top SolderMask: Black	Bottom SolderMask: Black
Date: 20210111	Top Silkscreen: White	Bottom Silkscreen: White

SDA SCL GND VCC

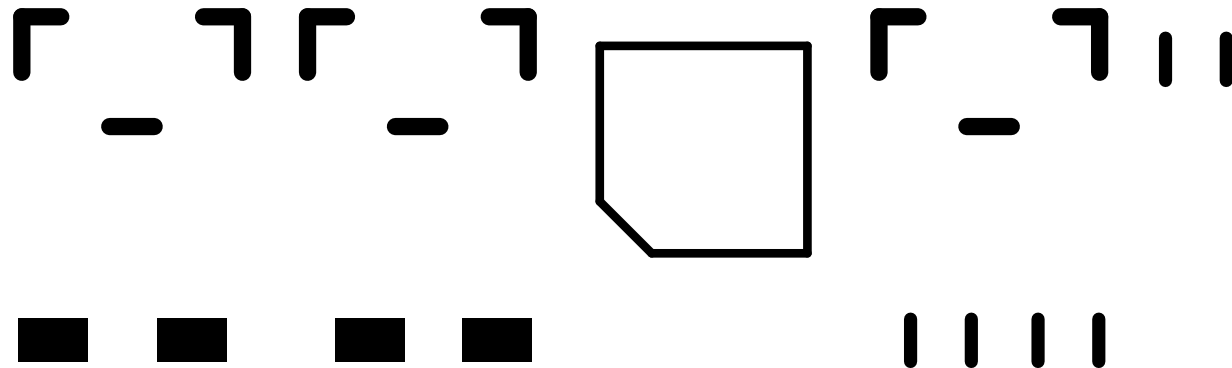

PCB Information	Name:SEN0392[V1.0]	Thickness: 1.0mm
Engineer:lfwag_CD	Top SolderMask: Black	Bottom SolderMask: Black
Date: 20210111	Top Silkscreen: White	Bottom Silkscreen: White

VIN GND SCL SDA

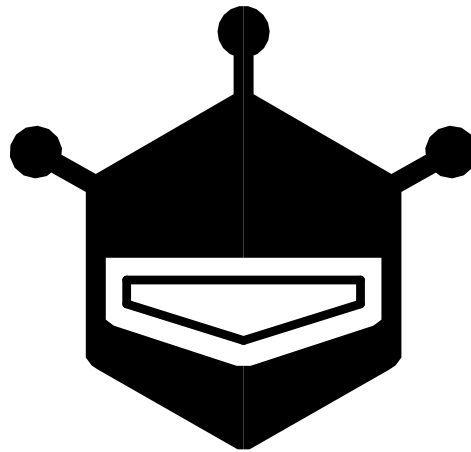

SGP40 Air Quality Sensor V1.0

PCB Information	Name:SEN0392[V1.0]	Thickness: 1.0mm
Engineer:lfwag_CD	Top SolderMask: Black	Bottom SolderMask: Black
Date: 20210111	Top Silkscreen: White	Bottom Silkscreen: White

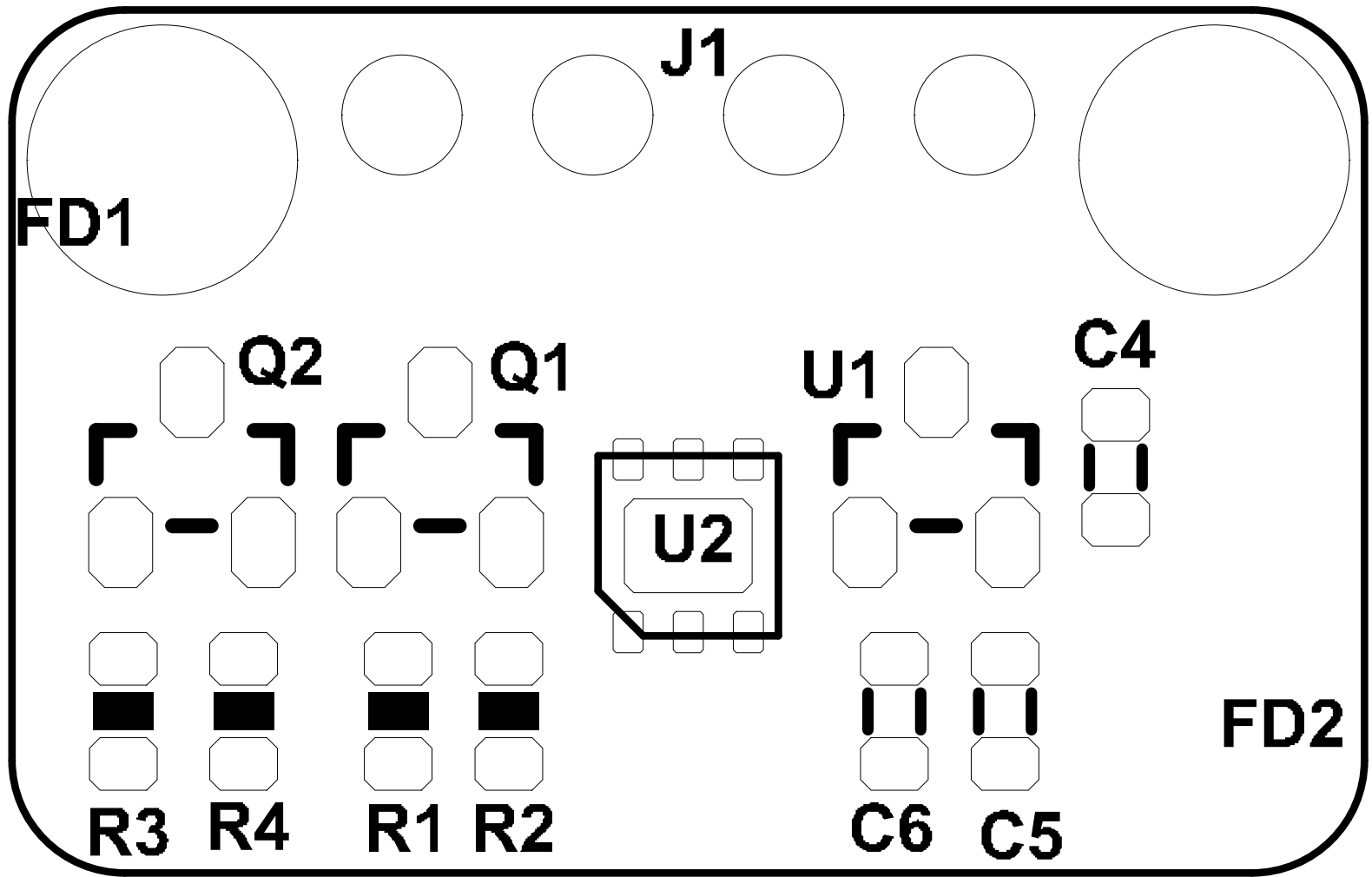

PCB Information	Name:SEN0392[V1.0]	Thickness: 1.0mm
Engineer:lfwag_CD	Top SolderMask: Black	Bottom SolderMask: Black
Date: 20210111	Top Silkscreen: White	Bottom Silkscreen: White

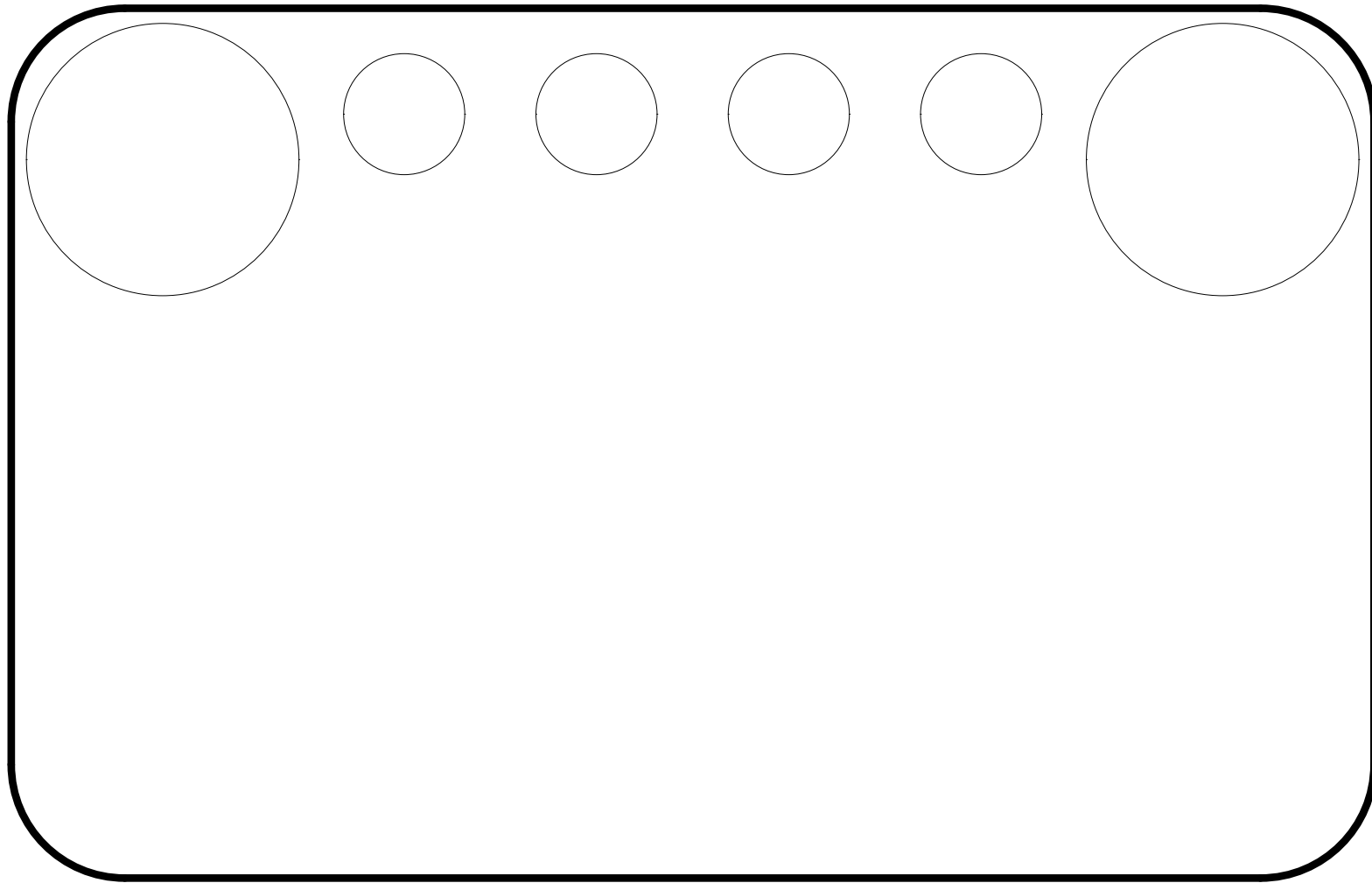

PCB Information	Name:SEN0392[V1.0]	Thickness: 1.0mm
Engineer:lfwag_CD	Top SolderMask: Black	Bottom SolderMask: Black
Date: 20210111	Top Silkscreen: White	Bottom Silkscreen: White

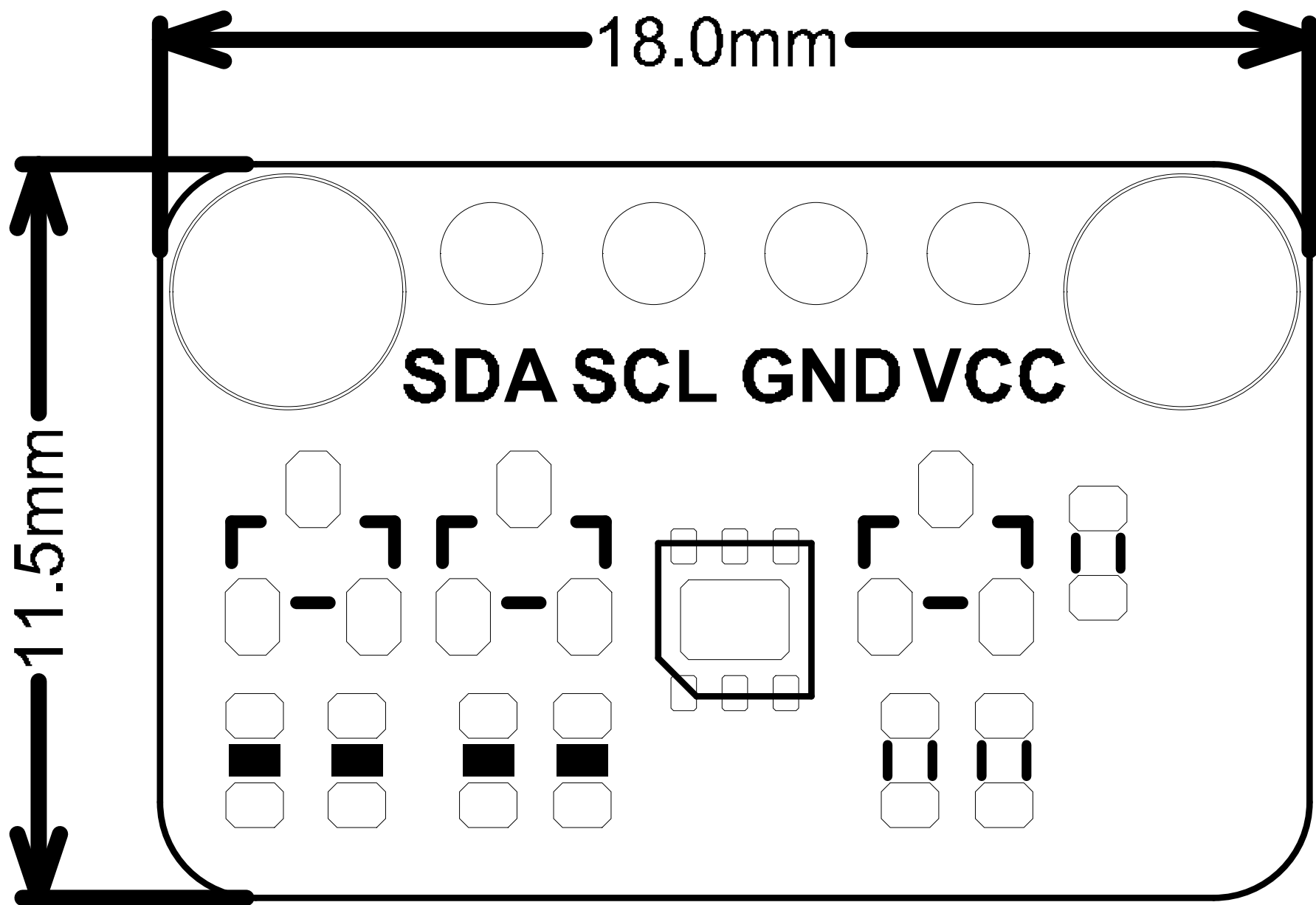

PCB Information	Name:SEN0392[V1.0]	Thickness: 1.0mm
Engineer:lfwag_CD	Top SolderMask: Black	Bottom SolderMask: Black
Date: 20210111	Top Silkscreen: White	Bottom Silkscreen: White

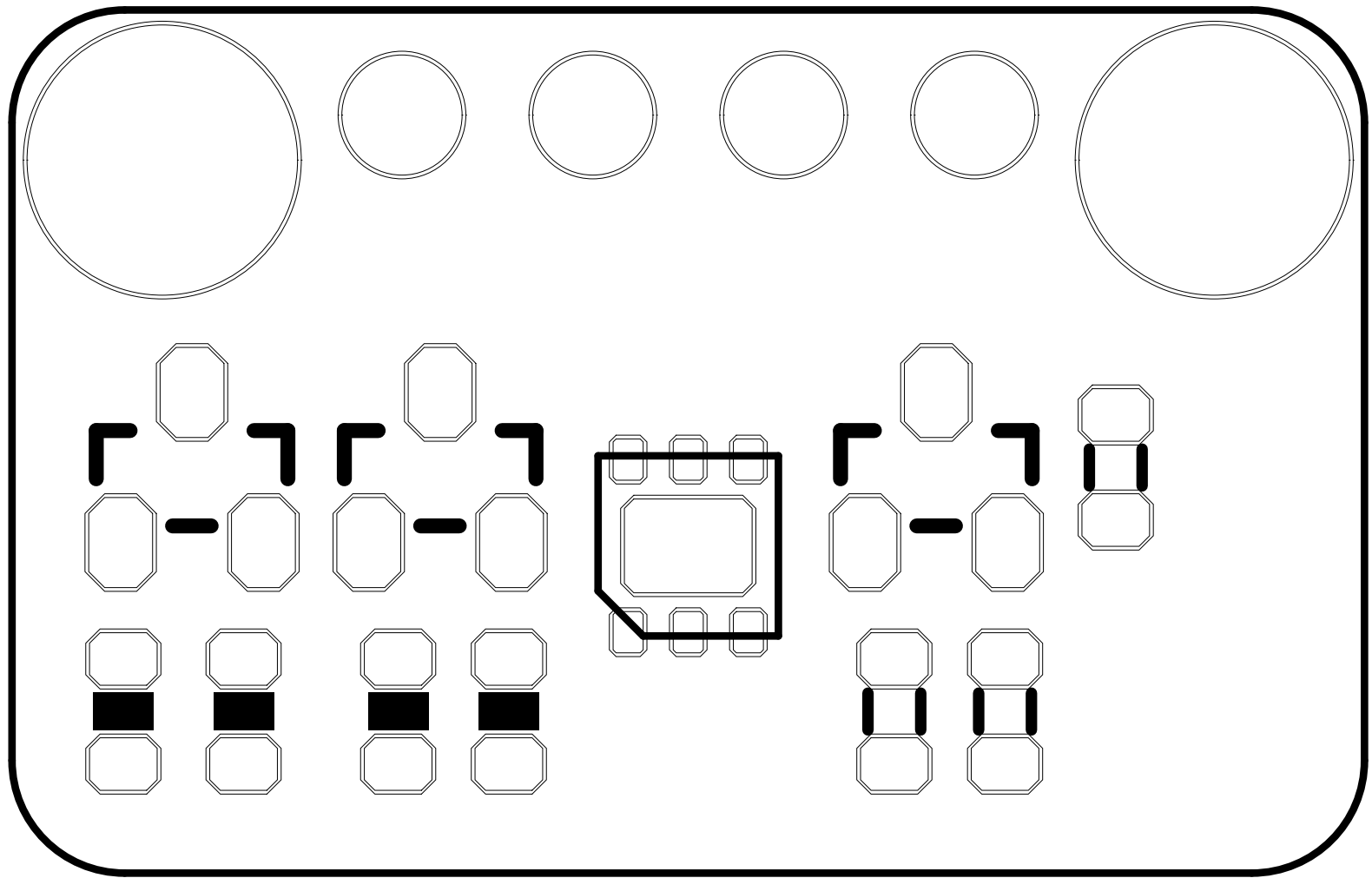

PCB Information	Name:SEN0392[V1.0]	Thickness: 1.0mm
Engineer:lfwag_CD	Top SolderMask: Black	Bottom SolderMask: Black
Date: 20210111	Top Silkscreen: White	Bottom Silkscreen: White

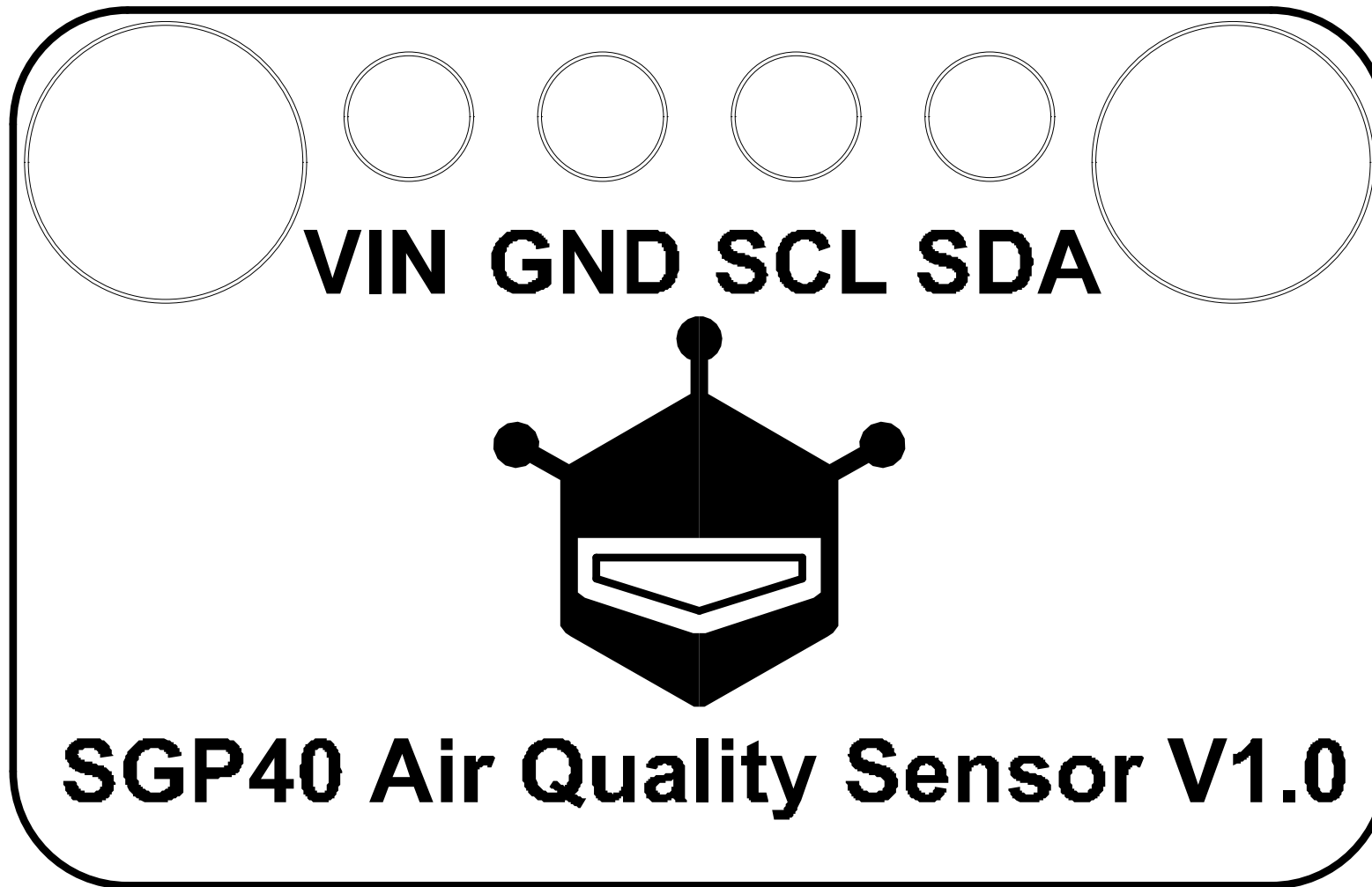

PCB Information	Name:SEN0392[V1.0]	Thickness: 1.0mm
Engineer:lfwag_CD	Top SolderMask: Black	Bottom SolderMask: Black
Date: 20210111	Top Silkscreen: White	Bottom Silkscreen: White