

Data sheet | Item number: 862-1594/999-950

4-conductor chassis-mount terminal strip; suitable for Ex e II applications;
without ground contact; PE-N-L1-L2; 4-pole; 4 mm²; 4,00 mm²; black



www.wago.com/862-1594/999-950



i Picture differs from the item.

Color:

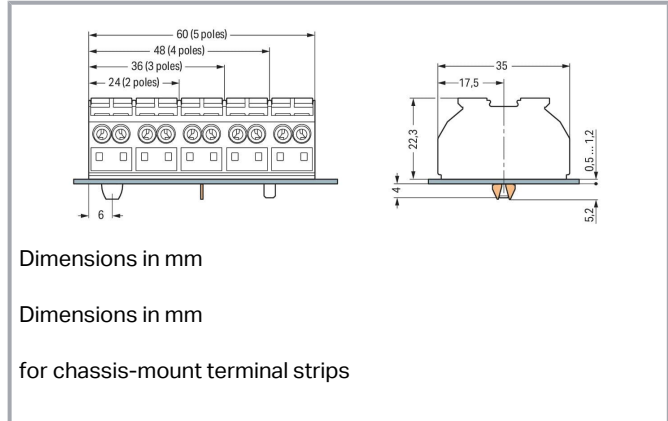

Dimensions in mm

Dimensions in mm

for chassis-mount terminal strips

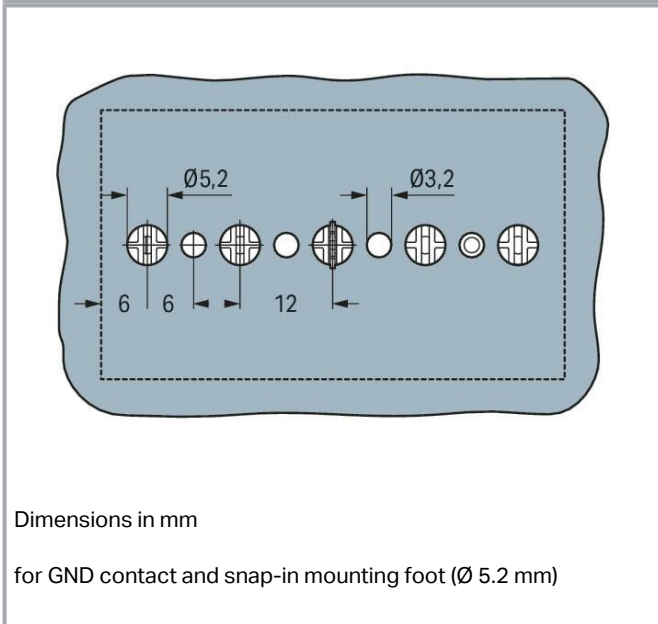

Dimensions in mm

for GND contact and snap-in mounting foot (Ø 5.2 mm)

Subject to changes. Please also observe the further product documentation!

WAGO GmbH & Co. KG
Hansastr. 27
32423 Minden
Phone: +49571 887-0 | Fax: +49571 887-169
Email: info.de@wago.com | Web: www.wago.com

Do you have any questions about our products?
We are always happy to take your call at +49 (571) 887-44222.



Data

Electrical data

Ex information

Rated voltage EN (Ex e II)	440 V
Rated current (Ex e II)	28 A

Connection data

Connection points	16
Total number of potentials	4
PE function	without PE contact

Connection 1

Connection technology	Push-in CAGE CLAMP®
Actuation type	Push-button
Connectable conductor materials	Copper
Solid conductor	0.5 ... 4 mm ² / 20 ... 12 AWG
Solid conductor; push-in termination	0.75 ... 4 mm ² / 18 ... 12 AWG
Stranded conductor	0.5 ... 4 mm ² / 20 ... 12 AWG
Fine-stranded conductor	0.5 ... 4 mm ² / 20 ... 12 AWG
Fine-stranded conductor; with insulated ferrule	0.5 ... 1.5 mm ² / 20 ... 16 AWG
Fine-stranded conductor; with ferrule; push-in termination	0.75 mm ² / 18 AWG
Note (conductor cross-section)	Depending on the conductor characteristic, a conductor with a smaller cross-section can also be inserted via push-in termination.
Strip length	10 ... 11 mm / 0.39 ... 0.43 inches
Pole number	4
Wiring direction	Side-entry wiring

Physical data

Pin spacing	12 mm / 0.472 inches
Width	48 mm / 1.89 inches
Height from the surface	22.3 mm / 0.878 inches
Depth	35 mm / 1.378 inches

Subject to changes. Please also observe the further product documentation!

WAGO GmbH & Co. KG
 Hansastr. 27
 32423 Minden
 Phone: +49571 887-0 | Fax: +49571 887-169
 Email: info.de@wago.com | Web: www.wago.com

Do you have any questions about our products?
 We are always happy to take your call at +49 (571) 887-44222.



Mechanical Data

Marking	±-N-L1-L2
Mounting type	Snap-in foot at pos. 1+4

Material Data

Note (material data)	Information on material specifications can be found here
Color	black
Material group	I
Insulation material	Polyamide (PA66)
Flammability class per UL94	V0
Fire load	0.505 MJ
Halogen-free	Yes
Weight	27.4 g

Commercial data

eCl@ss 10.0	27-14-11-06
eCl@ss 9.0	27-14-11-06
ETIM 8.0	EC001284
ETIM 7.0	EC001284
PU (SPU)	200 pcs
Packaging type	bag
Country of origin	DE
GTIN	4045454804176
Customs tariff number	85369010000

Environmental Product Compliance

RoHS Compliance Status	Compliant, No Exemption
------------------------	-------------------------

Approvals / Certificates

General approvals

Logo	Approval	Additional Approval Text	Certificate name
	CCC	GB/T 3836.3	2020312313000178
	CNEX		(Ex eb IIC Gb, Ex eb I Mb)

Subject to changes. Please also observe the further product documentation!







CSA
DEKRA Certification B.V.

C22.2 No. 158

1505030





Approvals for hazardous areas

Logo	Approval	Additional Approval Text	Certificate name
	ATEX Physikalisch Technische Bundesanstalt (PTB)	-	PTB 03 ATEX 1189 U (II 2 G Ex eb IIC Gb bzw. I M 2 Ex eb I Mb)
	CCC CNEX	GB/T 3836.3	2020312313000178 (Ex eb IIC Gb, Ex eb I Mb)
	EAC Brjansker Zertifizierungsstelle	TP TC 012/2011	RU C-DE.AM02.B. 00127/19 (Ex e IIC Gb U)
	IECEX Physikalisch Technische Bundesanstalt	IEC 60079	IECEX PTB 05.0003 U (Ex eb IIC Gb or Ex eb I Mb)



Optional accessories

Ferrule		
Item no.:	Description	Link
216-142	Ferrule; Sleeve for 0.75 mm ² / 18 AWG; uninsulated; electro-tin plated; electrolytic copper; gastight crimped; acc. to DIN 46228, Part 1/08.92	www.wago.com/216-142
216-143	Ferrule; Sleeve for 1 mm ² / AWG 18; uninsulated; electro-tin plated; electrolytic copper; gastight crimped; acc. to DIN 46228, Part 1/08.92	www.wago.com/216-143
216-141	Ferrule; Sleeve for 0.5 mm ² / 20 AWG; uninsulated; electro-tin plated; electrolytic copper; gastight crimped; acc. to DIN 46228, Part 1/08.92	www.wago.com/216-141
216-144	Ferrule; Sleeve for 1.5 mm ² / AWG 16; uninsulated; electro-tin plated; electrolytic copper; gastight crimped; acc. to DIN 46228, Part 1/08.92; silver-colored	www.wago.com/216-144
216-241		

Subject to changes. Please also observe the further product documentation!

	Ferrule; Sleeve for 0.5 mm ² / 20 AWG; insulated; electro-tin plated; electrolytic copper; gastight crimped; acc. to DIN 46228, Part 4/09.90; white	www.wago.com/216-241
	Item no.: 216-242 Ferrule; Sleeve for 0.75 mm ² / 18 AWG; insulated; electro-tin plated; electrolytic copper; gastight crimped; acc. to DIN 46228, Part 4/09.90; gray	www.wago.com/216-242
	Item no.: 216-243 Ferrule; Sleeve for 1 mm ² / AWG 18; insulated; electro-tin plated; electrolytic copper; gastight crimped; acc. to DIN 46228, Part 4/09.90; red	www.wago.com/216-243
	Item no.: 216-244 Ferrule; Sleeve for 1.5 mm ² / AWG 16; insulated; electro-tin plated; electrolytic copper; gastight crimped; acc. to DIN 46228, Part 4/09.90; black	www.wago.com/216-244

Marking accessories

Marking strip		
	Item no.: 709-178 Marking strips; on reel; 7.5 mm wide; not stretchable; plain; snap-on type; white	www.wago.com/709-178
	Item no.: 709-177 Marking strips; on reel; 7.5 mm wide; not stretchable; plain; snap-on type; translucent	www.wago.com/709-177

Jumpers

Jumper		
	Item no.: 862-482 Jumper; for conductor entry; insulated; black	www.wago.com/862-482

Tool

Operating tool		
	Item no.: 210-720 Operating tool; Blade: 3.5 x 0.5 mm; with a partially insulated shaft; multicoloured	www.wago.com/210-720

Testing and measuring

Testing accessories		
	Item no.: 210-136 Test plug; 2 mm Ø; with 500 mm cable; red	www.wago.com/210-136

Downloads

Documentation

Bid Text

862-1594/999-950	2019 Feb 19	xml	Download
------------------	-------------	-----	----------

Subject to changes. Please also observe the further product documentation!



X81 - Datei			3.8 kB	
862-1594/999-950	2017 Jun 13	doc		Download
doc - Datei			25.6 kB	

Additional Information

Technical Section		pdf		Download
Technical explanations			2.2 MB	

CAD/CAE-Data

CAD data

2D/3D Models 862-1594/999-950		URL		Download
-------------------------------	--	-----	--	----------

CAE data

EPLAN Data Portal 862-1594/999-950		URL		Download
WSCAD Universe 862-1594/999-950		URL		Download
ZUKEN Portal 862-1594/999-950		URL		Download
WSCAD Universe 862-1594/999-950		URL		Download
EPLAN Data Portal 862-1594/999-950		URL		Download

Environmental Product Compliance

Compliance Search

Environmental Product Compliance 862-1594/999-950		URL		Download
4-conductor chassis-mount terminal strip; suitable for Ex e II applications; without ground contact; PE-N-L1-L2; 4-pole; 4 mm ² ; 4,00 mm ² ; black				

Installation Notes

Subject to changes. Please also observe the further product documentation!

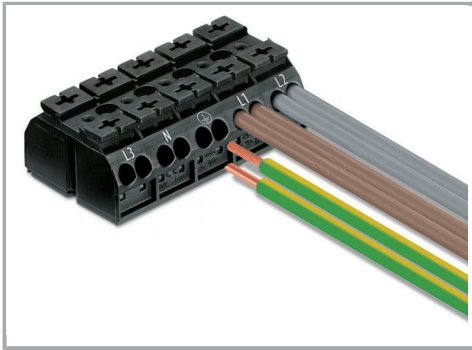

Cost-effective features:

WAGO's 862 Series Chassis-Mount Terminal Strips were developed specifically to minimize wiring costs, while accommodating requirements for flexible mounting, multiple connection points and easy usage:

- Equipped with Push-in CAGE CLAMP®, the 862 Series connects up to four conductors sized 0.5 to 4 mm² (20 ... 12 AWG). Due to multiple connection points per pole, different conductor sizes can be used within the same terminal block position.
- For factory wiring, Push-in CAGE CLAMP® Connection Technology allows solid conductors, fine-stranded conductors with ferrules or ultrasonically bonded conductors from 0.5 ... 4 mm² (20 ... 12 AWG) to be terminated by simply pushing them into unit (length of bonded conductor end: min. 10 mm).
- Convenient automatic grounding contact (optional)
- Snap-in mounting feet for fast assembly
- Push-buttons for easy installation with an operating tool or by hand
- Built-in test points simplify testing with 2 mm Ø test plug
- Standard marking for each pole, or custom marking for large orders

Conductor termination

Subject to changes. Please also observe the further product documentation!

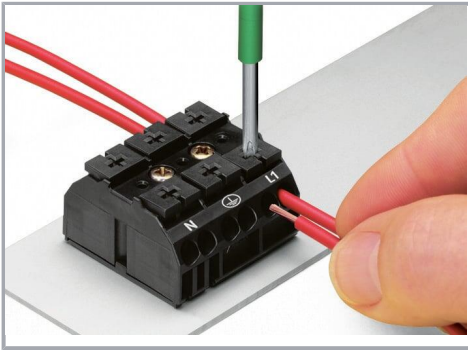

Terminating four conductors per pole – solid and fine-stranded.

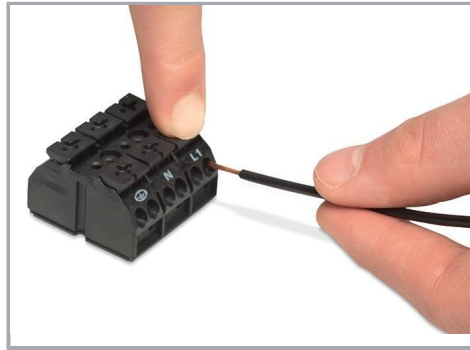

Inserting a conductor via push-button.

Commoning

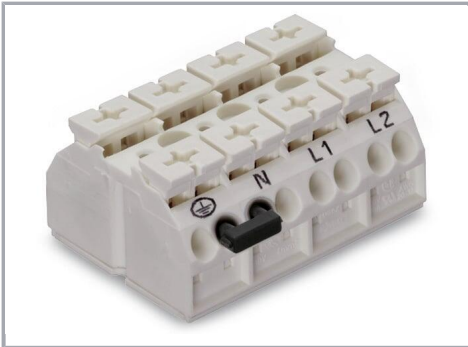

Commoning using a comb-style jumper bar (862-482).

Testing

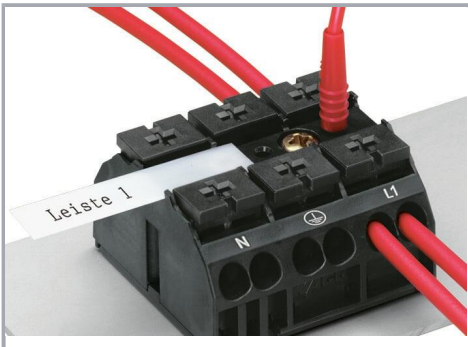

Testing with a 2 mm Ø test plug (max. 42 V).

Subject to changes. Please also observe the further product documentation!

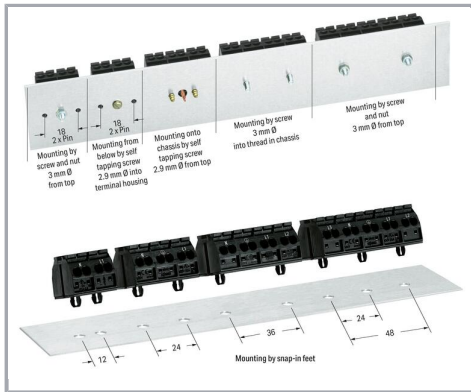

Dimensions in mm

Marking

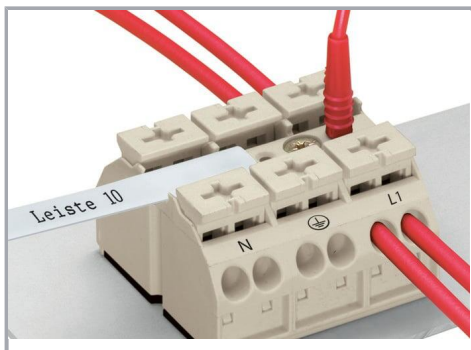

Marking by direct, one-side printing and marking strips

Subject to changes. Please also observe the further product documentation!