

# SMT ISOLATION TRANSFORMERS

## LOW POWER ISOLATION TRANSFORMERS



Low Power Isolation Transformers are used in a wide-assortment of applications and circuits for the communications, computing, medical, industrial and automotive market segments. Traditionally isolation transformers were used to isolate signals between low voltage and high voltage circuits, provide voltage to gate drive circuitry and turn-on and control IGBTs. In addition, they are used to power isolated communication interfaces such as RS-232 and RS-485. With the proliferation of high voltage battery packs in automotive and energy storage applications the demand for compact, high isolation transformers is growing exponentially.

Isolation transformers are used primarily in energy transfer topologies such as push-pull, half-bridge or full-bridge but they are also used in energy storage topologies such as quasi resonant and discontinuous mode flybacks.

The selection of the appropriate isolation transformer will depend on:

1) End-Application Safety Requirements

- \* Minimum isolation voltage to comply with the applications working voltage.
- \* Level of insulation (Functional, Basic, Reinforced)
- \* Minimum safety distances (creepage and clearances)

2) End-Application Electrical Requirements

- \* Selected Topology
- \* Input and Output Voltages which will dictate the turns ratio
- \* Operating Frequency which, along with the input voltage will set the volt-usecs
- \* Output power to ensure the selected component is sized correctly

Pulse parts are designed to be UL and TUV compliant where indicated in accordance the IEC60950, IEC61558, IEC60601 safety standards.

Selected designs have also been safety standard certified.

Pulse offers both commercial and automotive grade parts.



High Side, Low Side H-Bridge

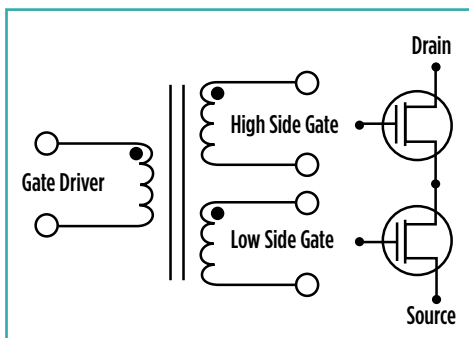



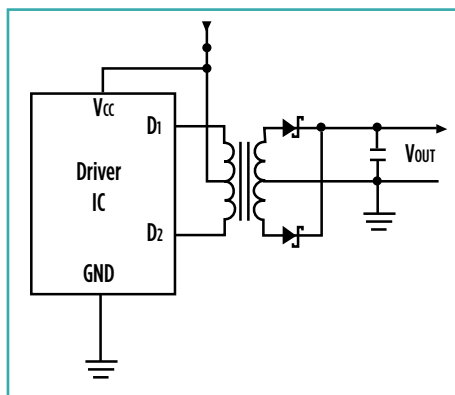

Push-pull Isolation Transformer

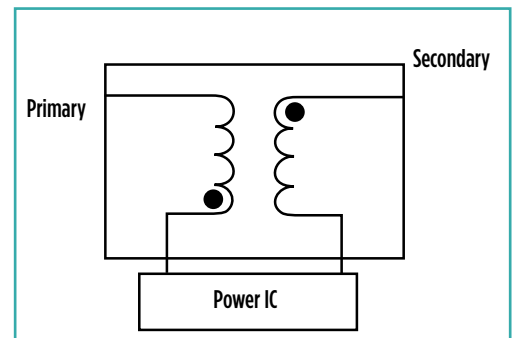

Flyback Isolation Transformer



## SMT Isolation Transformer Solutions

|                                                                                     | Dimensions |      |      | Series                                            | Isolation            | Insulation          | UL Creepage | Volt-usec Rating (V-usec) | Topology                      | IATF |
|-------------------------------------------------------------------------------------|------------|------|------|---------------------------------------------------|----------------------|---------------------|-------------|---------------------------|-------------------------------|------|
|                                                                                     | L          | W    | H    |                                                   |                      |                     |             |                           |                               |      |
|    | 6.6        | 5.8  | 5.3  | PH9084                                            | 1500Vrms             | Functional          | -           | 28-37                     | Energy Transfer (schematic 1) | -    |
|    | 7.1        | 6.1  | 5.5  | PA2777                                            | 1500Vrms             | Basic               | 1.4mm       | 9.3                       | Energy Transfer (schematic 4) | -    |
|    | 8.0        | 6.6  | 5.3  | P0926                                             | 1500Vdc              | Functional          | -           | 23                        | Energy Transfer (schematic 2) | -    |
|    | 8.3        | 6.9  | 3.0  | PGI427                                            | 2700Vdc              | Functional          | -           | 21-30                     | Energy Transfer (schematic 3) | -    |
|    | 8.6        | 6.7  | 2.5  | PE-68386, PA2001                                  | 1500Vrms             | Functional          | -           | 21-30                     | Energy Transfer (schematic 4) | -    |
|    | 8.6        | 6.7  | 3.6  | PA0264, PA2004                                    | 1000Vrms             | Functional          | -           | 12-20                     | Energy Transfer (schematic 2) | -    |
|    | 9.5        | 7.1  | 5.3  | PA1323                                            | 1500Vrms             | Functional          | -           | 21.7                      | Energy Transfer (schematic 4) | -    |
|    | 10.2       | 7.5  | 11.0 | PH9572, PH9572A                                   | 1500Vrms<br>2500Vrms | Functional<br>Basic | 12.0        | 42.84                     | Energy Transfer (schematic 1) | -    |
|    | 9.5        | 8.1  | 5.1  | PH9085, PM2180                                    | 2500Vrms             | Functional          | -           | 22.24                     | Energy Transfer (schematic 1) | Yes* |
|   | 11.8       | 8.8  | 4.0  | P0544, PA2002                                     | 1500Vdc              | Functional          | 1.4mm       | 45-60                     | Energy Transfer (schematic 2) | -    |
|  | 11.8       | 8.8  | 4.0  | PA0184, PA0297, PA0510,<br>PA2007, PA2008, PA2009 | 1500Vrms             | Basic               | 1.4mm       | 27-53                     | Energy Transfer (schematic 2) | -    |
|  | 11.8       | 8.8  | 4.0  | PA0173, PA0185<br>PA2005, PA2006                  | 1500Vrms             | Basic               | 1.4mm       | 17-26                     | Energy Transfer (schematic 2) | -    |
|  | 10.9       | 9.7  | 2.7  | PA3493                                            | 1650Vrms             | Basic               | 1.4mm       | 21.7                      | Energy Transfer (schematic 4) | -    |
|  | 10.0       | 10.0 | 12.5 | PH9184                                            | 4000Vrms             | Basic               | 4.0mm       | 200-296                   | Energy Transfer (schematic 1) | -    |
|  | 10.0       | 10.0 | 12.5 | PH9185, PM2190                                    | 5000Vrms             | Reinforced          | 8.0mm       | 36-110                    | Energy Transfer (schematic 1) | Yes* |
|  | 10.5       | 10.3 | 12.5 | PH9496                                            | 2500Vrms             | Basic               | 6.2mm       | -                         | Energy Transfer (schematic 4) | -    |
|  | 9.2        | 12.5 | 7.6  | PH9384, PM2185                                    | 4000Vrms             | Reinforced          | 8.3mm       | -                         | Energy Transfer (schematic 1) | Yes* |
|  | 13.0       | 10.0 | 12.5 | PH0416                                            | 5000Vrms             | Reinforced          | 8.3mm       | -                         | Energy Transfer (schematic 4) | -    |
|  | 13.0       | 12.0 | 7.1  | PH9363                                            | 2500Vrms             | Basic               | 2.8mm       | -                         | Energy Transfer (schematic 4) | -    |
|  | 16.5       | 15.6 | 7.1  | PH9385, PM2155                                    | 4000Vrms             | Basic               | 12.0mm      | 70-109                    | Energy Transfer (schematic 1) | Yes* |
|  | 16.7       | 16.5 | 14.2 | PH9400, PH9400A                                   | 4000Vrms             | Basic               | 12.0mm      | 125-375                   | Energy Transfer (schematic 1) | -    |

\*See specific datasheet for details

Available Schematics  
(multiple turns ratios available)

