



**CUI INC**

a bel group

date 01/25/2022

page 1 of 5

**SERIES:** VFM-03 | **DESCRIPTION:** DC POWER LINE FILTER

**FEATURES**

- 3 A maximum filter
- frequency attenuation to 20 dB
- available in DIP, Chassis and DIN rail mounting options
- optimized for reducing EMI noise on DC power line

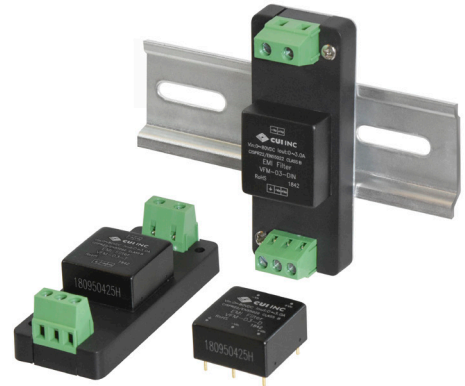

**SPECIFICATIONS**

parameter	conditions/description	min	typ	max	units
input voltage		0		80	Vdc
input current				3	A
noise attenuation	at 150 kHz ~ 1 GHz		20		dB
isolation voltage				1,500	Vdc
RoHS	yes				
operating temperature		-40		85	°C
storage temperature		-55		125	°C
storage humidity	non-condensing	5		95	%
case temperature rise	at nominal current			40	°C

Notes: 1. All specifications are measured at Ta=25°C, humidity < 75%, unless otherwise specified.

**PART NUMBER KEY**

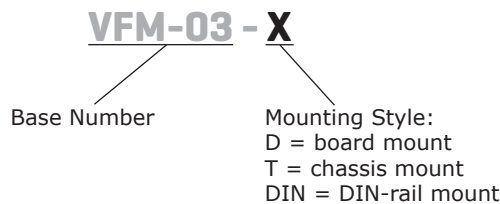

## SOLDERABILITY<sup>2</sup>

parameter	conditions/description	min	typ	max	units
hand soldering	for 3~5 seconds	350	360	370	°C
wave soldering	see wave soldering profile			260	°C

Note: 2. For board mount models only.

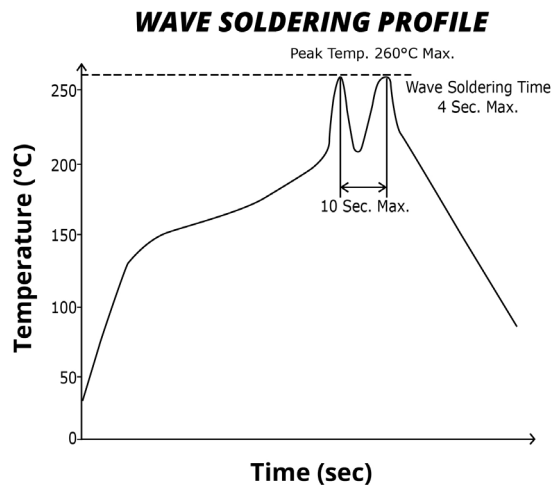

## MECHANICAL

parameter	conditions/description	min	typ	max	units
dimensions	board mount: 25.40 x 25.40 x 11.70 [1.000 x 1.000 x 0.461 inch] chassis mount: 76.00 x 31.50 x 21.20 [2.992 x 1.240 x 0.835 inch] DIN-Rail mount: 76.00 x 31.50 x 25.80 [2.992 x 1.240 x 1.016 inch]				mm
case material	aluminum alloy				
weight	board mount chassis mount DIN-rail mount		15 35 55		g

## MECHANICAL DRAWING (BOARD MOUNT)

units: mm [inch]  
tolerance:  $\pm 0.50[\pm 0.020]$   
pin diameter tolerance:  $\pm 0.10[\pm 0.004]$   
pin height tolerance:  $\pm 0.50[\pm 0.020]$

PIN CONNECTIONS	
PIN	Function
1	+Vin
2	-Vin
3	GND
4	-Vout
5	+Vout

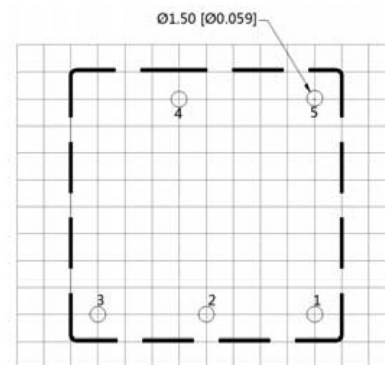
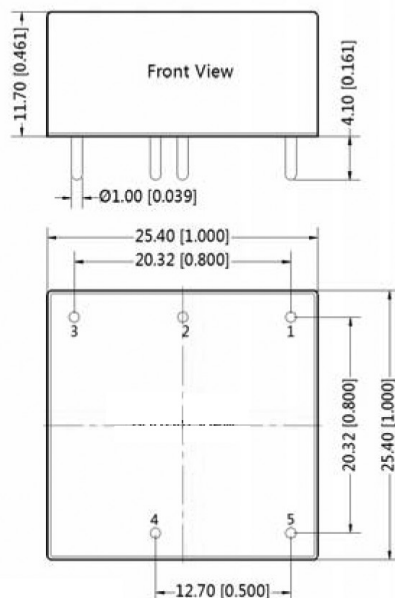

Note: Grid 2.54\*2.54mm  
Recommended PCB Layout  
Top View

## MECHANICAL DRAWING (CHASSIS MOUNT)

units: mm [inch]  
tolerance:  $\pm 0.50[\pm 0.020]$

wire range: 24~12 AWG  
tightening torque: 0.4 N\*m max

PIN CONNECTIONS	
PIN	Function
1	+Vin
2	-Vin
3	GND
4	-Vout
5	+Vout

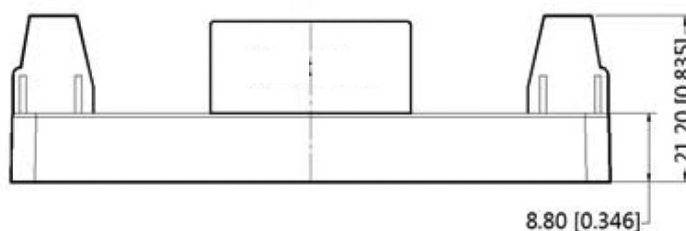
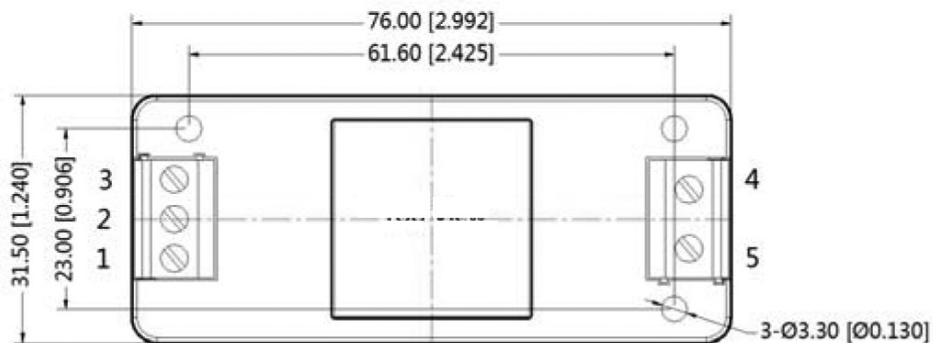

## MECHANICAL DRAWING (DIN-RAIL MOUNT)

units: mm [inch]  
tolerance:  $\pm 0.50[\pm 0.020]$

installed on DIN rail TS35  
wire range: 24~12 AWG  
tightening torque: 0.4 N\*m max

PIN CONNECTIONS	
PIN	Function
1	+Vin
2	-Vin
3	GND
4	-Vout
5	+Vout

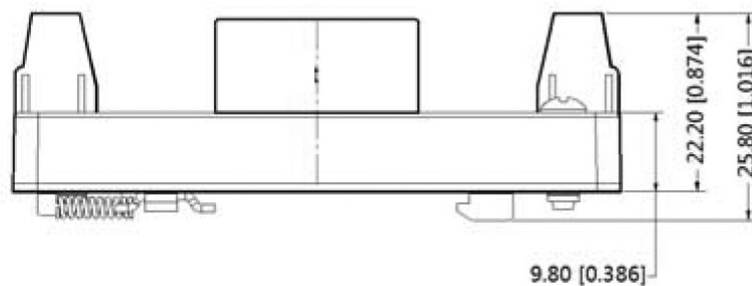
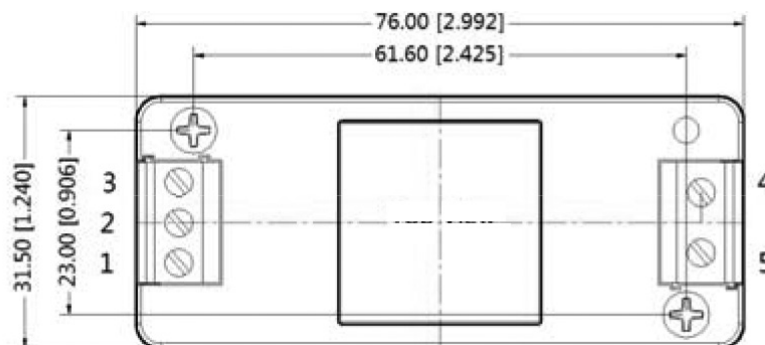

## APPLICATION CIRCUIT

Figure 1  
Application Circuit

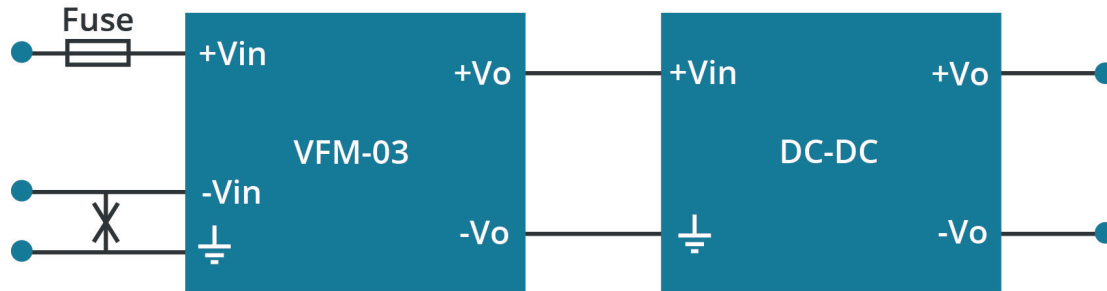
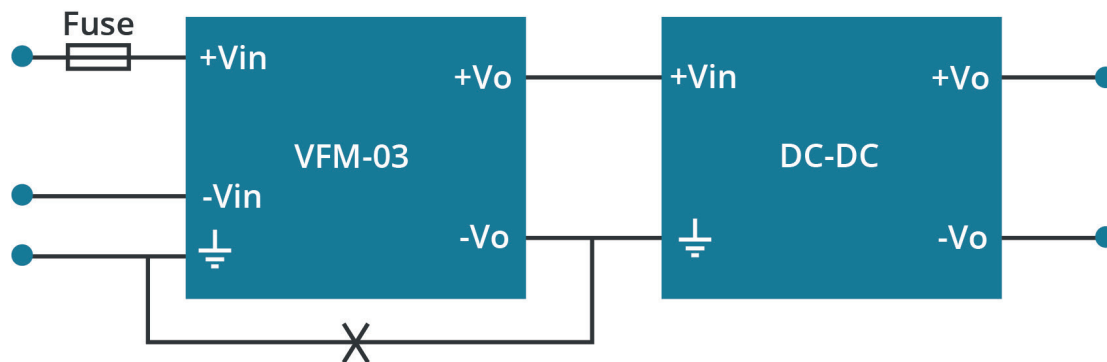

Figure 2  
Non-supported Application for Module



## REVISION HISTORY

---

rev.	description	date
1.0	initial release	12/17/2018
1.01	circuit figures updated, packaging removed	01/25/2022

The revision history provided is for informational purposes only and is believed to be accurate.



**Headquarters**  
20050 SW 112th Ave.  
Tualatin, OR 97062  
**800.275.4899**

Fax 503.612.2383  
**cui.com**  
techsupport@cui.com

CUI offers a two (2) year limited warranty. Complete warranty information is listed on our website.

CUI reserves the right to make changes to the product at any time without notice. Information provided by CUI is believed to be accurate and reliable. However, no responsibility is assumed by CUI for its use, nor for any infringements of patents or other rights of third parties which may result from its use.

CUI products are not authorized or warranted for use as critical components in equipment that requires an extremely high level of reliability. A critical component is any component of a life support device or system whose failure to perform can be reasonably expected to cause the failure of the life support device or system, or to affect its safety or effectiveness.